



**RAGNAR'S
BIG BOOK
OF HOMEMADE WEAPONS**

**Building and
Keeping Your
Arsenal Secure**

Ragnar Benson



PALADIN PRESS
BOULDER, COLORADO

CONTENTS

Introduction 1

PART ONE Mantrapping 7

Chapter 1	
Introduction	9
Chapter 2	
Philosophy	11
Chapter 3	
Triggers.....	15
Chapter 4	
Pit Trap	23
Chapter 5	
Sheepeater's Rockfall.....	27
Chapter 6	
Cuban Water Trap.....	31
Chapter 7	
Spike Trap.....	35
Chapter 8	
Jungle Snare	39
Chapter 9	
Jack The Tank Killer	43

PART TWO Homemade Grenade Launchers 47

Chapter 10	
Introduction	49
Chapter 11	
Home Construction of an M79.....	51
Chapter 12	
Home Construction of an M203.....	57

PART THREE Breath of the Dragon 63

Chapter 13	
Introduction	65
Chapter 14	
History of Flamethrowers	67
Chapter 15	
Construction of a Flamethrower	73
Chapter 16	
Manufacturing Napalm	83

PART FOUR Home and Recreational Use of High Explosives 89

Chapter 17	
Introduction	91

Chapter 18
Basic Procedures95

Chapter 19
Doing the Work105

Chapter 20
Improvised Detonating Caps117

PART FIVE
Homemade C-4 121

Chapter 21
Introduction123

Chapter 22
Ammonium Nitrate125

Chapter 23
Nitromethane.....129

Chapter 24
Home Manufacture of C-4131

Chapter 25
The Finished Product.....139

Chapter 26
Conclusion143

PART SIX
Grenades 145

Chapter 27
Background147

Chapter 28
Use of Homebuilt Hand Grenades.....155

Chapter 29
Home Construction of Hand Grenades159

PART SEVEN
Mortars 167

Chapter 30
Mortar Background.....169

Chapter 31
Mortar Deployment173

Chapter 32
Home Construction of a Working Mortar ...177

PART EIGHT
Claymores 185

Chapter 33
Claymore Background187

Chapter 34
Claymore Mine Deployment191

Chapter 35
Home Construction of Claymore Mines.....195

PART NINE
Modern Weapons Caching 201

Chapter 36
Introduction203

Chapter 37
Caching and You.....205

Chapter 38
Modern Caching Technology211

Chapter 39
Caching vs. Hiding.....221

Chapter 40
Outsmarting the Enemy.....227

PART TEN
Gunrunning for Fun and Profit 231

Chapter 41
Introduction233

Chapter 42
Making Connections.....237

Chapter 43
Markets.....241

Building and Keeping Your Arsenal Secure

Chapter 44
Sources of Supply.....249

Chapter 45
Shipping and Delivery257

Chapter 46
Suitcase Running263

Chapter 47
Making Gunrunning a Business269

Chapter 48
Getting Paid273

Chapter 49
Practical Advice for Getting Started277

Conclusion 279

INTRODUCTION

When the idea for *Ragnar's Big Book of Homemade Weapons* first came up, I was really excited. I knew that it was exactly the kind of book that I would buy if someone else had written it. The general idea was to gather together under one cover information about all the weapons and explosives one could build himself to protect himself, his family, and his property—or just to enjoy if he happens to be a powder monkey or weapons wizard like me—as well as all the practical survival skills necessary to keep his arsenal safe.

Some of the material would come from my previous explosives and weapons books. I knew that I would have to review and update the information to pass along the latest innovations and test results. Looking over my previous books, I saw that a big book of homemade weapons should include C-4, grenade launchers, flamethrowers, and high explosives as well as sections on weapons caching, gunrunning, and mantrapping.

My excitement mounted when I realized that I'd also have to come up with new material on explosives I had not yet written about. For example, I had not yet gotten around to grenades, mortars, or claymores. That meant a whole new round of building and experimenting with these explosives until I had the formulas and directions down pat. "What luck," I thought. Then I realized that I'd have to write an introduction to the book to explain the book's purpose. That was a bit tougher.

I knew why I thought the book was needed. In this increasingly restrictive climate we live in, this book was to be a final hedge against governmental and societal encroachment. *They* might make weapons and explosives illegal, but they'll never take them—not as long as you've read the information in this book and heeded its advice. *They* might even make books like this illegal in the future—but they could not take away the knowledge and skills learned from it.

The essence of self-sufficiency is realizing and agreeing to the truth that you are best served by being in control of your own destiny. This means staying off government lists, maintaining a low profile, and, above all, possessing the resources and skills necessary to decide your own fate.

It isn't necessarily that society has grown more complex, as many of the freedom-grabbing leftists maintain. It seems that the United States has grown into a collection of beggars who genuinely believe government can solve their problems. In that regard we have weapons laws, environmental laws, drug laws, building laws, farming laws, and personal social codes (always somebody else's).

Most of these would have been totally unthinkable in our society even a relatively few years ago. Instead of minding our own business we mind the other guy's business for him, driving our entrepreneurs away, destroying our economy, and pushing society into a

hopeless cul de sac from which there seems to be no rescue.

Because our lives as loners are viewed as undesirable at best and illogical at worst, many people find it not only convenient but necessary to operate with a great deal of obscurity. This is especially true in relation to the use of high explosives and heavy weapons.

After deciding what should go into the book, I thought about the kind of person who would benefit from it. The first person to come to mind was my good friend Maurice Given, who shares my survivalist philosophy (as well as my love of high explosives and heavy weapons). We live not far from each other as the crow flies but on opposite sides of the mountain, and we ground-bound crows sometimes find it tough to neighbor. At the time we met, Given had come to live in my part of the world, leaving behind what many would describe as a glamorous existence. He chose his new self-reliant life-style because he felt it was best for him and his family psychologically, financially, and physically.

Given was fortunate to have enough cash to purchase 160 acres of basically remote, inaccessible land. Fortune also smiled on him when he went land shopping in that he found a suitable tract with a good water well, healthy growing timber, and patches of deep, rich garden soil.

Given has what he has been told is a fully funded annuity from the government. Yet he is no fool. He realizes that his monthly check comes out of current government deficits and there is no such thing as a fully funded government annuity. He knows governments can and do go broke (or more frequently renege on their promises) and that to rely on the retirement check that he supposedly purchased with payroll deductions is the height of stupidity.

Twenty-five percent of the people in Given's profession never made it to their twenty-year retirement. He hasn't come all this way relying on government for his well-being. Confidence in government is, in his own words, the ultimate oxymoron, or hopeless contradiction.

Failure on the part of our elected officials to solve the triple scourge of oppressive taxation, inflated bureaucratic budgets, and economy-crippling regulations is not the only reason Given turned his back on what appeared to be an attractive life. He had traveled around the world sufficiently to explore much of its dark underbelly. He knows only too well that, in addition to government, there are many other threats to his survival and well-being, not the least of which is Mother Nature, who can be, and often is, a real bitch.

He experienced Bangladesh, Ethiopia, Uganda, Beirut, and the Philippines firsthand. He saw that many disasters, causing tens of thousands of deaths, were started by Mother Nature but magnified and exacerbated by strong central governments similar to those in the United States.

The best formula for disaster, he vehemently claims, occurs when Mother Nature strikes a blow in the form of a flood, earthquake, volcano, or forest fire, and those affected are conditioned to rely not on themselves but on government agencies and programs. Your only safety net is the one you carry around in your head, he often tells his friends.

During the twenty-year interval since he left this country, Given claims to have seen Americans degenerate from basic, self-reliant, confident, prosperous people to bitter, contentious people who make their way through life by searching for someone else to blame their problems on and government programs to set things right for them. Government is not a milk cow with 248 million tits, he excitedly proclaims.

Neither of us would be classified as young idealists. But working together as much as was prudent and possible, we set out to build an obscure yet secure life-style. We addressed our needs in a practical manner, as do most rational survivors.

The first need we took care of was food and water, followed by shelter, energy, security, and then self-fulfillment and creativity. Perhaps uniquely, we found our greatest enjoyment—read self-fulfillment and creativity—

making and using high explosives and manufacturing heavy ordnance.

Given, like me, is familiar and comfortable with both high explosives and large-bore ordnance. Familiarity in this case does not breed either contempt or paranoia. We realize full well that it would be stupidly easy to kill or maim ourselves manufacturing and using high explosives, flamethrowers, and heavy weapons. Because we know, respect, and enjoy—in their way—high explosives, we have a tremendous advantage when pursuing our way of life.

Without C-4, for instance, exploding warheads from our 40mm rounds, claymores, and mortars would not be possible. Coincidentally, we might require homemade C-4 to take out the only bridge on the only road to our retreat. It also may be necessary to cut steel girders, break concrete, or deal with a military-type vehicle by using our flamethrower.

Building and operating heavy weapons such as 80mm mortars and flamethrowers is not only entertaining, sans bureaucratic B.S., it is also inexpensive. Hobby builders can easily expect to produce an M-79 mortar or big batch of claymore mines for as little as \$50! Flamethrowers cost a bit more and are technically more complex, but even these done at home are not prohibitively expensive.

Considering our experience out in the wide world, neither Given nor I believe that conditions will stay the same. It is obvious to us that dramatic changes do occur and that they greatly impact people who are unprepared and inflexible. Just as the gardens we tend and firewood we gather to stretch our budgets may soon become absolutely essential in the near future, our weapons, now a hobby or curiosity, could be the difference between surviving and becoming government wards.

That is not to say that either of us is predicting imminent collapse, only that we know that throughout the world, it is common for governments—in conjunction with Mother Nature—to induce situations that destroy thousands of people at a whack. When it happens, what one sees is what one gets. It is entirely up to individ-

uals to tough it through based on their past experience and knowledge.

In that regard, knowledge is power. Perhaps a correlation exists between those who wish to withhold knowledge while simultaneously wishing to enforce their own social agenda on us. Many of the devices and explosives listed herein are now illegal. For many years they weren't. However, books telling the general public how to do make explosives are still protected by the First Amendment.

Supposedly, our right to unencumbered ownership of firearms is protected by the Second Amendment, but everyone in this business knows what is happening to these rights. Having this relatively inexpensive single-source weapons book available may be the best insurance one can purchase. And as I stated earlier, it may not be legal to buy or even own this book in the very near future. My guess is that this book will be completely prohibited in Canada and England right now.

I realize full well that not everyone can move to the sparsely populated country where they take up a semisubsistence life. It may be the best scenario for those who wish to remain independent, yet I know that living in some of the medium-size and smaller cities in the United States is, at this time, quite easy. We Americans are not threatened right now. There is a strong temptation to stay where one is comfortable.

Additionally, most people who really look at a subsistence life-style are put off by the hard work they face. It seems probable that if one is not born to this, he will have huge problems adapting to it. Given, to his advantage, was born to it, left it for a while, married a lady born to it, and decided to reenter it.

Many well-meaning, intelligent, hard-working readers will continue to live where they are, near high-paying jobs, housing, family, and friends, and where opportunities for self-reliance must be pushed rather than having them push you. Living in the city does not preclude learning how to make and use heavy weapons, high explosives, or scrounging loads of firewood out in the country. It does make it

a bit more work, but the rewards are still there. Everyone should, for instance, practice growing a garden wherever they are so that when the time comes, they know how to do so in their own soil and, in theory, their own climate zone. By doing so, they cut down dramatically on current food bills.

City people can participate in the adventure of self-reliance, it just takes more time and effort and, in some cases, additional smarts. To some extent, my life as a hermit on a mountain prevents me from really understanding how city people think. I do know, however, that people in cities have far more access to chemicals and manufactured goods than is available to me in the twillies. When I wish to build a mortar, for instance, I must either wait for a long time, pay more money, or do without needed parts. People in cities simply go immediately to the store and buy what they need. This book has a lot of practical information for them.

On the other hand, some people will choose to get as far away from "civilization" as possible. The best, most completely self-supporting retreat I built was located on 1,700 acres of rolling third-growth timberland in far western North Carolina. There were two families involved, plus some of our grown children along with friends who visited for weeks at a time to assist with the heavy construction. Looking back at it, I wonder how we kept everyone productively employed. But we did. Everyone put in fourteen-hour days for about a year until the main elements of our retreat were completed.

Land for the project was purchased by a wealthy Chicago businessman who wanted the place put in top shape as insurance against the time when everything in Chicago turns to worms. As soon as we could, we put in a gravel-underlaid sod air strip and wind sock. We also buried some fuel tanks. All of this would have gotten us in trouble with the FAA and the EPA, but there was no one to tell them. Other than the wind sock, it was tough to tell a landing strip lay there.

We were located forty miles from the county

seat, a town of about 12,000 people. The nearest place with gas stations and a phone was eighteen miles away. As it ultimately always is anyway, we were personally responsible for law and order on our own property.

Our first real project after taking ownership and walking the property boundaries was to punch a single-lane road—with truck turnouts—into the central building area. Fortunately, our road passed through a long, low marshy area and across two creeks. Building the road required that we blast through several rock outcroppings and then crush the rock for gravel fill. We hand-drilled the blast holes and rigged up a small crusher we rebuilt to run off our tractor's belt pulley.

Local authorities did not want us to have and use explosives. We solved that problem by mixing up our own explosives that we used to clear land, remove rock, and build road.

Even though we were too far from their offices for the agency people to harass us comfortably, they decided to give it a try anyway. Fortunately, they were unsure about anything going on back at the retreat. We did not allow any delivery vehicles into the building area, electing instead to truck everything from town ourselves.

Their first concern was our alleged rock crusher, leading to construction of an unauthorized road over flowing streams and through marshland that was home for some local muskrats.

Setting up an industrial activity outside the correct manufacturing zone was a violation, they warned us. Proper zone or no, I thought, it's our property, and we should be able to do as we please as long as we hurt no one. Of course, we didn't tell them that, electing instead to ignore their complaints.

"What you are doing is probably a violation of the rules," one of them hollered into the phone one day. "We must have an on-site inspection."

We knew it was time for more drastic measures. In the interim between telephone call and inspection, we punched an alternate side road up along the ridge away from our settle-

ment site. Toward the end of the road, we carefully built an excellent mantrap—which in this case it was actually a truck trap.

When the county planner called, ordering us to unlock our gate, we, of course, did so. We also put up an easily removed sign at the fork in the road, directing them to the trap at the dead end.

Sure enough, in their greed to enforce their petty regulations, collecting perhaps \$45 in permit fees, they drove down the end of the road where they were unceremoniously dumped—truck and all—down into a ravine. In this one case, government regulations provided a benefit. They were both wearing seat belts so, although the truck rolled once completely, no one was harmed. They were badly shaken up, and the truck was totaled but, most important, they didn't realize it was a trap.

At our signal, our wives and kids fired off several charges of C-4 on the bare ground near our building sites half a mile away. Noise from the throaty blasts roiled around the hills in a most insolent manner. By now the pair were so fearful of us and our property that they quickly took advantage of our offer of a ride back into town. Two of the kids took them out on their motorcycles.

Because of our remote location, we successfully billed the county \$400 to pull their pickup back up on the road. Regular tow operators didn't want to go that far and were asking much more money to do the job.

As a result of this incident, we were able to drive two water wells down, lay our household water pipe, and install the large master septic system without interference. No one really knew what was going on. The county sanitarian just stayed in his office.

Later in the fall, we did have another problem when our pond started to fill. It was about ten acres in size, averaging about six feet deep. The dam itself rose sixteen feet from the stream floor. We desperately needed the pond to provide fire protection, to raise fish for the table, and to generate a small amount of electricity as a backup for the diesel generator.

Other than the phone, we did not want to bring public utilities onto the property.

This time we had a much more thorough plan in mind.

Two huge railroad iron posts set in a yard of concrete held a solid welded-steel gate in place four miles up the road from the campsite. Deep cuts next to the road precluded driving around.

The bureaucrats called several times from the county seat trying to set a date for an inspection. We simply set the answering machine to talk to them. Things dragged on that way for the better part of a year till we had most of our planned permanent buildings up and in use. We had fields planted, livestock in pens, cattle grazing, etc. By then, we were pretty well self-sufficient.

About the only thing we needed from town was a few barrels of diesel for the tractor and generator, spare parts that came mail order, bags of cement, chemicals, seed, and at times some food, hardware, and medicine. We picked most of these up on our once-a-month forays to town. Things were well enough in hand that we thought about moving on.

Finally, the bureaucrats talked a sheriff's deputy into walking in from the gate to our house and barn area. There were six of them. It was a muggy, hot spring day when they came in. Because they were semiafraid we might shoot, they called ahead, giving us time to prepare. It was obvious that they were unsure of their moral and ethical reasons for the visit. All they had on their side were some laws that four men in town had passed one evening.

As they approached, most of us walked up on into a little wooded area on a hill. We sat down in the brush out of sight but certainly not out of mind. Several of the women stayed behind to profess ignorance and to take whatever messages they cared to leave.

These inspectors did not snoop around a great deal for fear of our nasty, free-ranging rottweilers. They contented themselves with trying to stay away from the dogs while they nervously looked about for the main party of people. About the most productive thing they did was

grumble about no permit from the Corps of Engineers for the dam and resulting ponds as well as the obvious buildings for which no county permit had been issued. Our ladies told them we were out checking our traps, but that they would surely pass the message on.

In less than an hour, they grew tired of standing in the hot sun listening to big dogs snap their jaws. After they left, they sent several nasty letters, but we contented ourselves with ignoring them.

It has been almost five years now. Apparently the matter has fallen into a black hole. They no longer try to contact us or otherwise offer harassment. They must have concluded that there are easier, more convenient targets for their petty rules. Perhaps one of the lessons of this incident is to try to site one's retreat in a poor county with weak, ineffective government. Perhaps this accounting will stir them up again, but I am reasonably sure that

these petty bureaucrats will not expend energy to read this book.

The information contained in this book was in part learned from and applied in this experience. Our expertise with demolitions and weapons gave us an upper hand in establishing our self-sufficient retreat and discouraging the bothersome bureaucrats who wanted to peek around and tell us what to do on our own land.

As indicated, this material is dedicated to the self-reliant person who also enjoys fooling around with heavy weapons, explosives, and retreat defense, as well as to the person who simply wants to live his life in anonymity. Good luck, and I hope this information will be of real value to you. It has been to me—in the above examples as well as many other instances. I guarantee you will not find anything like it in the average "eat nuts and berries" survival book.



PART ONE

MANTRAPPING

CHAPTER 1

INTRODUCTION

Without question, man can be the most difficult animal on earth to trap. Humans are certainly more intelligent than any other creature. Except in rare instances, however, they do not possess the individual sensory keenness that other species of mammals do. Yet man's collective senses—good sight, excellent perception of color and depth, some sense of smell, adequate hearing, and reasonable taste—provide him with an edge over species having one or, at the most, two, very well-developed sensory mechanisms.

A cage-raised mink that inadvertently finds its way to freedom is extremely easy to trap. Not so with its wild cousin, who can be as wily and cunning as any animal in North America.

MAN'S SENSORY ADVANTAGE FOR TERRITORIAL PROTECTION

Societies that still practice mantrapping tend to live close to the earth. For them, it is natural to progress from trapping small and big game to protecting their home territory with mantraps.

Americans and members of other urbanized civilizations have not fared very well on a one-to-one basis against societies that have attempted to mantrap them. But, because subsistence tribes tend to be small, suffering mightily from a high infant mortality rate, they have never posed much of a total threat to civilizations like ours.

People using primitive tools and materials might be able to trap several members of one patrol. Yet to continue to do so on a regular basis would, in most cases, be beyond their capacity. A modern army, ignoring the few casualties it sustained, would send in still larger, more mechanized forces until their primitive adversaries were overwhelmed by sheer numbers and attrition.

A PSYCHOLOGICAL THREAT

This is not to say that the havoc such resistance might create would not be individually lethal. The force a mantrap exhibits can indeed be deadly, particularly in a psychological sense.

Today, mantrapping naturally has evolved into the science of booby-trapping. Modern booby-trappers use explosives, complex electronic devices, and space-age fabrication processes to produce contrivances that, when left secretly behind, will kill or maim the enemy.

NOT BOOBY TRAPS—PRIMITIVE ORIENTATION

Many texts and military manuals have been written about booby-trapping. An especially great proliferation of these books occurred after the U.S. Vietnam experience.

Booby traps are not what this book is about. Rather, it is about constructing primitive

Mantrapping devices using only hand saws, axes, shovels, rope or wire, and knives. The assumption throughout this book is that the reader will not have explosives, detonating devices, flammable liquids, manufactured chemicals or any other modern instrument of war at his disposal. Nor will I assume the tools available to you be any more sophisticated than a chain saw which, of course, could be replaced by a hand saw or axe.

There are a number of reasons for sticking exclusively with primitive-type traps. Anybody who wants information about modern booby traps can get it out of any number of easily obtained texts on the subject.

Perhaps most importantly, to know how to set a trap for your enemy is also to know how to avoid being trapped yourself.

A DEFENSIVE TOOL

Mantrapping, which is almost always defensive in nature, can doubtlessly be used to help win wars. Where the terrain is rugged enough and the country expansive, traps can be set that so demoralize the attackers they will come to the conclusion that the game is not worth the candle. For years the Jivaros of the upper Amazon River basin successfully used traps as part of their defense against European intrusion. Fidel Castro killed Batista soldiers in mantraps, and the early Indians of North America often set traps for one another. Currently, Afghanistan rebels and guerrilla fighters are using rock traps in the mountains to trap government tanks and other armor.

The mantrapping sets described in this book are typical, and are based on actual systems that I have personally encountered while

traveling the world on special assignments over the past thirty years. In field use, these mantraps do work. In fact, it has been my sad misfortune to lose a number of close associates to these deadly efficient—however crude—devices. Put another way, they do an excellent job of separating the ranch minks from the wild ones.

ANTHROPOLOGICAL AND HISTORICAL INTEREST

I also feel that this work should be of interest to anthropologists and historians. For though mantraps have played an important role in many primitive societies, they have never been thoroughly discussed in any other book. Since many of these tribes are dying out, this information may well have passed into oblivion if I had not written *Mantrapping* in 1981.

During the last fifty years, Americans have pretty well forgotten the art of trapping in general. Many otherwise astute military people have little idea that devices such as mantraps are still around. To some extent, the use of booby traps in southeast Asia changed this.

MODERN SOLDIERS PAY HEED

Yet for the most part, the average modern soldier is ill prepared for a falling log or rolling stone. Obscurity notwithstanding, these are good reasons for the truly prepared freedom fighter to study mantrapping. This book covers many of the best devices. Hopefully, it will help you be prepared when the time comes. If nothing else, it should keep your own ass out of someone else's sling.

CHAPTER 2

PHILOSOPHY

A good trapper is a shrewd outdoorsman who has an eye for detail. A successful mantrapper is an incredibly shrewd outdoorsman who notices every detail around him.

A SOMALIAN EXAMPLE

I remember well my days tracking and then trapping men on the east coast of Africa. We used Somali trackers exclusively. These people's perception of detail was, and I believe still is, the best in the world. Time after time I was totally awed by the accurate description they gave me of the number, age, and strength of forces they evaluated on the basis of tracks in the bush that I couldn't even see.

The final conclusive argument in favor of these people being the best there is came one day when my interpreter drew me into a discussion about trees. We were to travel south by foot for about thirty kilometers, where we were to meet a second group at a prespecified baobab tree. To my amazement, I learned that the Somalis have more than a dozen words just to describe the shape of baobabs. It was very possible and quite common for them to describe an individual tree so exactly that a person who had never seen it before could walk right to the exact tree thirty kilometers away, just as though the trunk had a sign on it!

That is what I call perception of detail. Americans don't even have the linguistic abili-

ty to accomplish this, much less the mentality that would allow such a thing in their culture.

CHOOSING A LOCATION

Traps set for people must be made in harmony with the surrounding country, maintaining a complete paranoid emphasis on every detail.

The trap has to fit the place in which it is constructed. If one is going to roll logs down a hill, there have to be logs occurring naturally in the immediate area. Do not plan on bringing in bushels of stones, for instance, where none exist, or digging pits in swamps or on the tops of rocky mountains.

All existing cover must be utilized. Pay attention to the kinds of brush and grass that are native to the immediate area. What is the color of the subsoil? Do not attempt to use a limb to hide a rope that is from a tree of a variety that does not grow within one hundred meters of the set.

Dead grass is a dead giveaway, if there is no other like it within sight. Dried and withered branches are also taboo.

When any trap is set, the surrounding area must be altered as little as possible. Many times this will entail constructing the principal parts of the device far from the place of use. Dirt, sticks, and rocks that are turned up in the process of placing the trap must be moved far away, and hidden.

CONSTRUCTION TEAMS ARE BEST KEPT SMALL

Usually the terrain is such that virtually all of this work has to be accomplished using muscle power. Construction of mantraps is not usually speeded up materially by adding people to the work crew. In most cases, there are a limited number of people who can do this type of labor. Even if more people are available, they begin to stumble over each other, creating so many obvious signs that the set is ruined.

If you have an abundance of good people, split them into two or three crews and build at different locations. Just be sure there is good communication between the various parties, or you may start stumbling into each other's traps. At other times, materials may be at such a premium that the use of more than one crew is impossible.

RESTORING SET TO ORIGINAL APPEARANCE

When the set is completed, it has to look natural. That means no foreign construction materials, no unusual ground or foliage disruption, no sawdust, chips, freshly scraped rocks, or bad smells. In other words, nothing can be out of place when you are finished.

If there were tracks on the path in the dust before the trap was placed, there will have to be tracks on the path after it is there. If there were leaves, there will have to be leaves, and so on.

Sometimes the solution to this problem can be very clever. I have seen Somali warriors whittle logs down to duplicate animal tracks and put them on poles that they "walked" through a finished set. The tracks looked very natural on the trail, leading the victim into the trap too far to be saved.

Another similar technique is to put animal feet on poles and run a set of animal tracks through the trap area. Good scouts know that, in many cases, wild animals are more cautious about where they walk than people are.

Many traps are made best by using wire,

rope and nails. All of these marks of civilization must be covered by mud, brush, water, grass, leaves, or limbs.

Do not leave newly chopped logs, freshly dug earth, newly split rocks, or any other signs of recent activity around, even if they are far from the set. Shrewd scouts will know what these discarded materials are for and will be doubly alert.

KEEP NOISE LEVEL DOWN

Be very cautious about making noise while preparing a set. At times I have had a chain saw available but didn't use it because of noise. It might have caused people on the trail or in villages in the vicinity to take note of what was happening. Don't forget, mantraps are usually defensive in nature. As a rule, they have to be set on home territory. When operating with closely knit, tight-mouthed partisans who hate the intended quarry, one can work openly and without concern. Otherwise, use a great deal of caution and stealth.

SAFETY SIGNALS FOR FRIENDLIES

In this regard, it is imperative that you not catch the wrong game. Nothing sours the attitude of villagers you are trying to protect more than having one of their children impaled on a torqued spike trap. At a minimum, friendly natives in the vicinity must be warned that the traps exist. At best, the people should be shown exactly what has been prepared, and where.

Sometimes it is possible to work out a meaningless little signal to warn away the people you are trying to protect. A handful of leaves in the path, a small hanging vine or some other item may be used. Generally, the people you will be working with will be astute enough to spot traps and avoid them if they know they are there. The only real danger is to small children, who sometimes range an incredible distance from their villages.

At times, traps can be set beyond one's safe territory. Safe territory is defined as

Building and Keeping Your Arsenal Secure

being country where the enemy may come in to patrol infrequently, but never stays for very long. Mantraps set inside the enemy's lines have a limited harassing effect. The negative is that the set-up operations tend to be so dangerous the results are hardly ever worth the risk.

Obviously, mantrapping does not work in a combat zone. It is foolish to contemplate reaching any significant military objectives by these means. But in the rear areas, where the traps can be set at one's good pleasure, they can be individually devastating, especially against city soldiers.

CHAPTER 3

TRIGGERS

The heart of any trapping system is the trigger. Without a simple, foolproof trigger to release the stored energy that the mantrap contains, other elaborate preparations are a foolish waste of time.

A trigger used to control a mantrap must be able to withstand just about anything Mother Nature is likely to throw at it. Really good triggers always have that characteristic. Neither rain, snow, mud, nor heat should affect a good design, so care must be taken to provide protection for the trigger against the elements.

As with everything else in this business, good common sense helps immeasurably when selecting or developing a trigger.

DIFFICULTIES WITH TRIGGER CONSTRUCTION

At times it will seem virtually impossible to come up with any kind of credible trap/trigger combination. The trap itself may be one that can be hidden, but the correct materials for the trigger may not be on hand. Or the trigger may not lend itself to the application you have in mind. Sometimes the people you want to catch may be tipped off if they glimpse even a trigger or, for that matter, the entire set of terrain characteristics that go along with a trigger and mantrap.

My advice is to continue to work patiently on these sorts of problems, and tough it out. Blend your experience with local culture and,

in turn, with available technology. Eventually an approach will evolve that will work very nicely; at least it always has for me.

If you become involved in mantrapping, and if you are good at it, you will begin to develop unique traps of your own invention. The trigger systems I list here are basic, simple designs that can be used in many applications. As you begin to invent triggers yourself, keep in mind that they must meet the following basic criteria. A trigger must:

- A. be simple
- B. be absolutely foolproof
- C. not be affected by the normal range of weather one might expect
- D. be made of common, easily obtained materials
- E. be easily hidden
- F. not contain an inherent set of characteristics that will immediately tip off the subject you are trying to trap

People who are pragmatically familiar with the outdoors and who have run a trap line for small or large game will not have to be reminded of the above points. Others need to remember to use a large enough trigger for the trap they envision being sprung.

DOUBLE-TRIGGER CONCEPT

One not-at-all-well-known concept is that of

TRIGGER

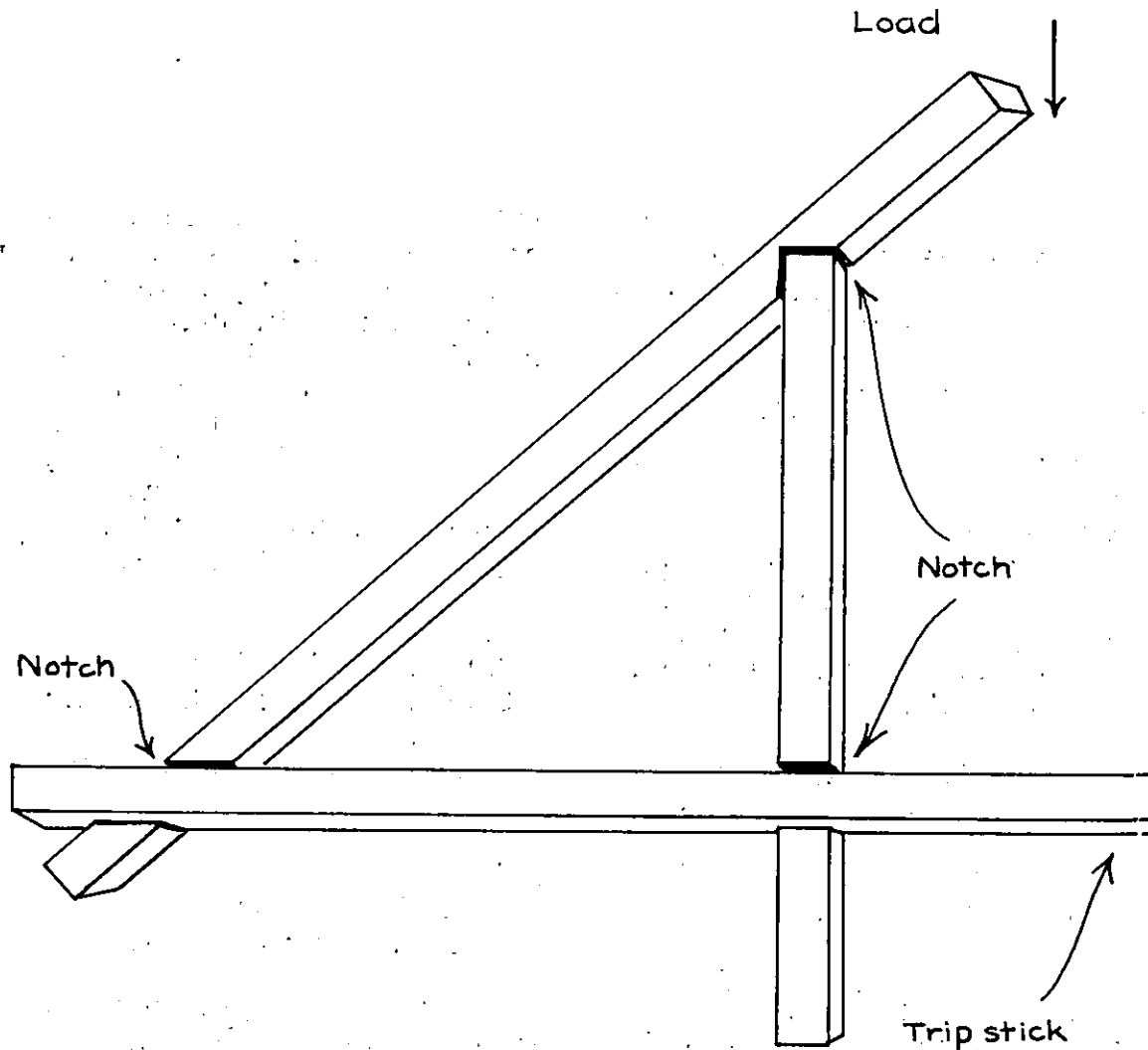

using a double trigger. This involves the principle of tripping a smaller trigger that in turn activates a main trigger which, in turn, is hold-

ing back a pile of rocks or stack of logs. Many times this system can be comprised of two triggers that are identical in design. An example

here is a small figure four trigger that trips, allowing a log to fall, tripping a large figure four trigger holding back a big load of rocks.

A falling rock double trigger may be easier to conceptualize. Here a rock is set on the very edge of a steep path. When nudged by a passing patrol leader, it rolls downhill. A buried wire line leading from the rock to a trigger under a massive log deck then tightens, tripping the trigger. The result is a cascade of falling logs, and hopefully a smashed patrol.

Keep the double trigger concept in mind. Often it is the key to dropping half a mountain on an adversary (or some similarly drastic event) that could not otherwise be accomplished with only a single trigger.

FIGURE FOUR TRIGGER

The figure four is the oldest, most reliable release mechanism in existence. North American Indians used it to trigger their deadfalls. Rendille and Samburo natives around Lake Rudolph in Africa still use it today.

Generally a figure four trigger will work wherever the trap consists of a load held up by an angled support. It is simple and effective. The device is not easily affected by the weather. No matter where one is in the world, there are usually readily available materials with which to build a figure four.

Describing a figure four trigger is needlessly difficult. There just is not that much mystery to them. Take a look at the drawing on the opposite page. It is much easier to understand than trying to follow a complicated word description.

When making a figure four, be sure the bait stick is long and dry. All of the pieces should be made of well-seasoned material that won't warp, shrink, or soften during the useful life of the trap.

PIECE SELECTION

The horizontal piece is especially crucial. A long, light member is easiest to dislodge. Those unfamiliar with traps will be amazed at

how much energy can be contained by these few, relatively small sticks.

As you become proficient at mantrapping, other triggers will come to mind. Measure their effectiveness against a figure four, especially in the area of jamming. Nothing is so maddening as having pieces of the trigger hang up, keeping the trap unsprung when it should slam into action. I have had this happen without the enemy ever knowing they were in my trap. But usually they end up seeing the set and are doubly wary from then on.

TRIP STICK TRIGGER

Many potentially good triggers are too slow on the uptake to be of much value. As a result, the quarry may walk past the impact area before there is any trap movement. Not only will he not be trapped, but the trap may be so slow in activating that the victim may never know he was a target.

Most trip stick triggers suffer from these sorts of limitations. The one I like is somewhat more reliable but is still slow. Yet mantrappers need a trigger of this type in their repertoire. Mine is, as far as I know, about the best of the lot. If necessary, one can make up for any inherent slowness by having the load drop ahead on the path a few meters.

On the plus side, the trigger will work either horizontally or vertically, and it will contain a tremendous stack of logs, a huge bent tree, or a mountain of rocks.

PARTS LIST

The basic parts of this trigger are a pivot pole, a post, a pivot stick with rope to the trap, and a trip stick.

Notice from the accompanying drawing that the pivot pole is set up on a constructed post. This is not always necessary or wise. Often I have used the limb of a tree for a pivot pole. Similarly the post can be a naturally occurring tree. In fact, it is better if it is. The set will certainly look more natural. As with any trap, the trick is to develop an eye for the really

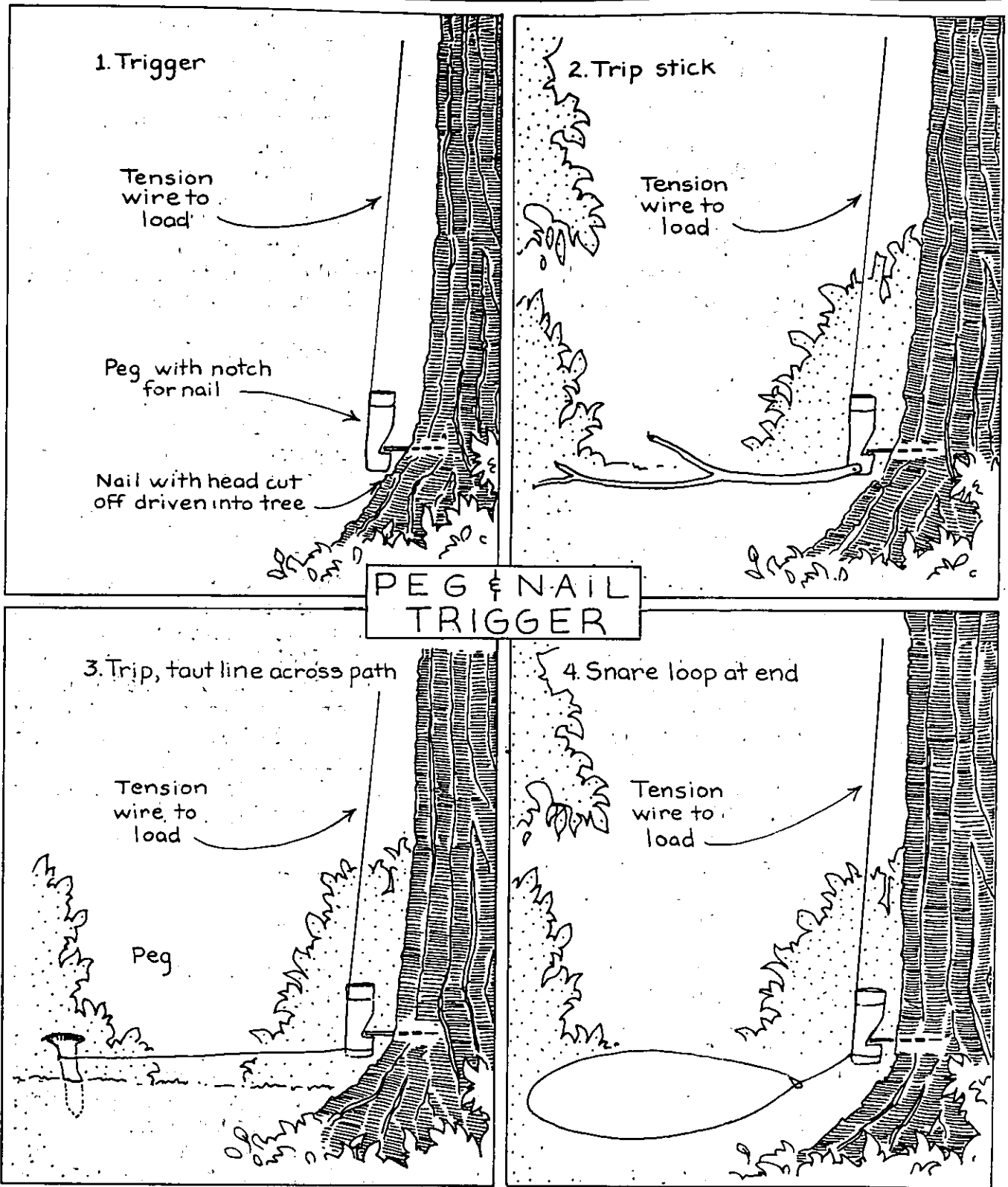

good places where traps can be built that blend well into the surroundings.

As shown in the diagram, the trip stick is above the ground in what seems like an

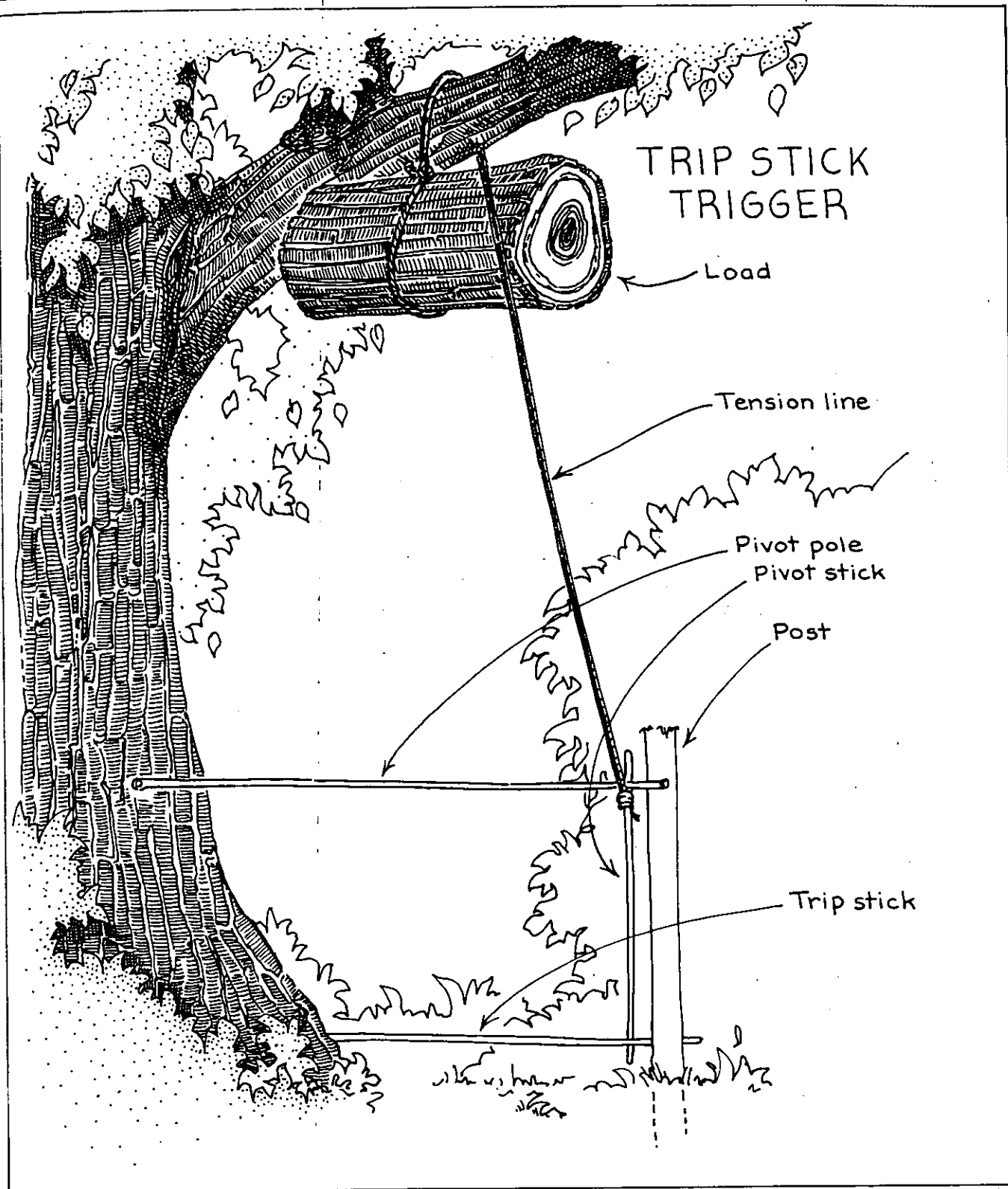

exposed, obvious position. Many times the trip stick can be hidden or camouflaged. Inex-

perienced city troops will walk right into it anyway, covered or uncovered. Trapping them

is like trapping marten. If you leave the trap uncovered, they seem to find it easier.

A USEFUL VARIATION

A very nice derivative of the exposed trip stick can be made by shallow burial of the trip in the ground on top of light filler, such as leaves or thistledown. The trigger must be minutely adjusted to work properly, which is not particularly difficult with this type of trigger.

Notice that the pivot stick can be obvious as it swings. Should this seem like a problem, build the set so the pivot stick is off the path several feet, screened by brush. By the time the quarry figures out what is happening, it is too late.

Trip stick triggers can be traps in and of themselves. I ran into several in Cuba years ago. The first one tripped when I hit some foliage with a machete. It swung a tremendous blow with its pivot stick that went low under my arm. We tripped the second with a pole. Both were much like the standard Jivaro traps.

PEG AND NAIL TRIGGER

As a general rule, most snares operate with a trigger using the peg and nail concept. It's a good, simple device for this type of trigger setup.

With only a modest amount of tinkering, the trigger can be made to hold back a man-whomping load. Yet it can be very sensitive too.

PEG AND NAIL VARIATIONS

Wire from a spring (or tension) pole is run to a peg. Precut a notch in the peg before securing the wire. Drive a nail into a tree, log, or stoutly anchored stake, and that's all there is to this one. It can be triggered by positioning it so it is simply kicked out of position. Or the peg can be connected to a trip line, a branch, a stone, or a light wire snare loop that has been run to it. This last method is the most common use of the peg and nail trigger.

Always build the trigger fairly large for the intended application. In actual use, I have found this to be the best way to make a sensi-

tive trip. Cutting the head off the nail increases sensitivity greatly. A very heavy primary force exerted by the bent spring pole will cut the trigger's potential sensitivity substantially.

Be sure the peg is made out of the hardest wood available. Grooves cut in the top of the peg will help keep the tension wire tightly wound in place.

Be sure the mechanics of the trigger are such that a 90-degree pull off the nail is created when upset. Otherwise the mechanism may not activate without a huge tug or push from the quarry.

STICK AND ROLLER TRIGGER

Often a fairly insensitive trigger is needed that can hold up a huge weight. Under these circumstances, the triggers are set in two stages, as previously mentioned. The secondary trigger may, for instance, be a stick and roller that holds up a log deck, which is tripped by a falling rock trigger.

Smaller traps occasionally may be built using the stick and roller as the primary and only trigger.

To be successful, the roller has to be made of materials that are smooth, round, and hard. It should be relatively large in diameter and roll on a hard surface.

TRIGGER SENSITIZERS

At times it can be a real chore to get one of these triggers sensitized. One cannot go around rolling logs down the hill time after time till the trigger pieces are finally worked down enough to function properly. If nothing else, the trap setter will probably object to having logs rolled on his head.

When I make one of these sets, I start out with a relatively light load and implant temporary posts to stop the load close to the set. This way I can test the trigger time after time, adding a bit more weight as needed.

On a trigger of this sort, the best way to sensitize it is to angle the stick from the load to the

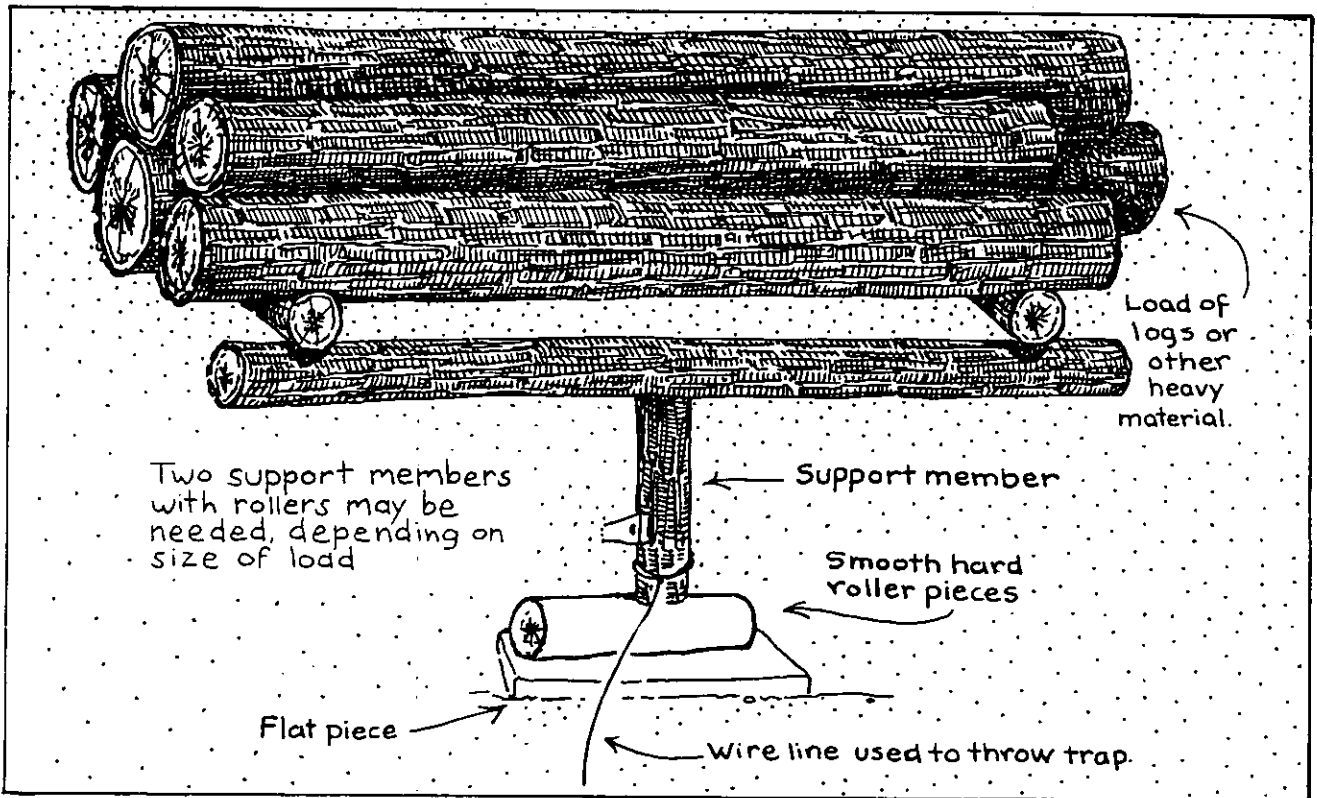
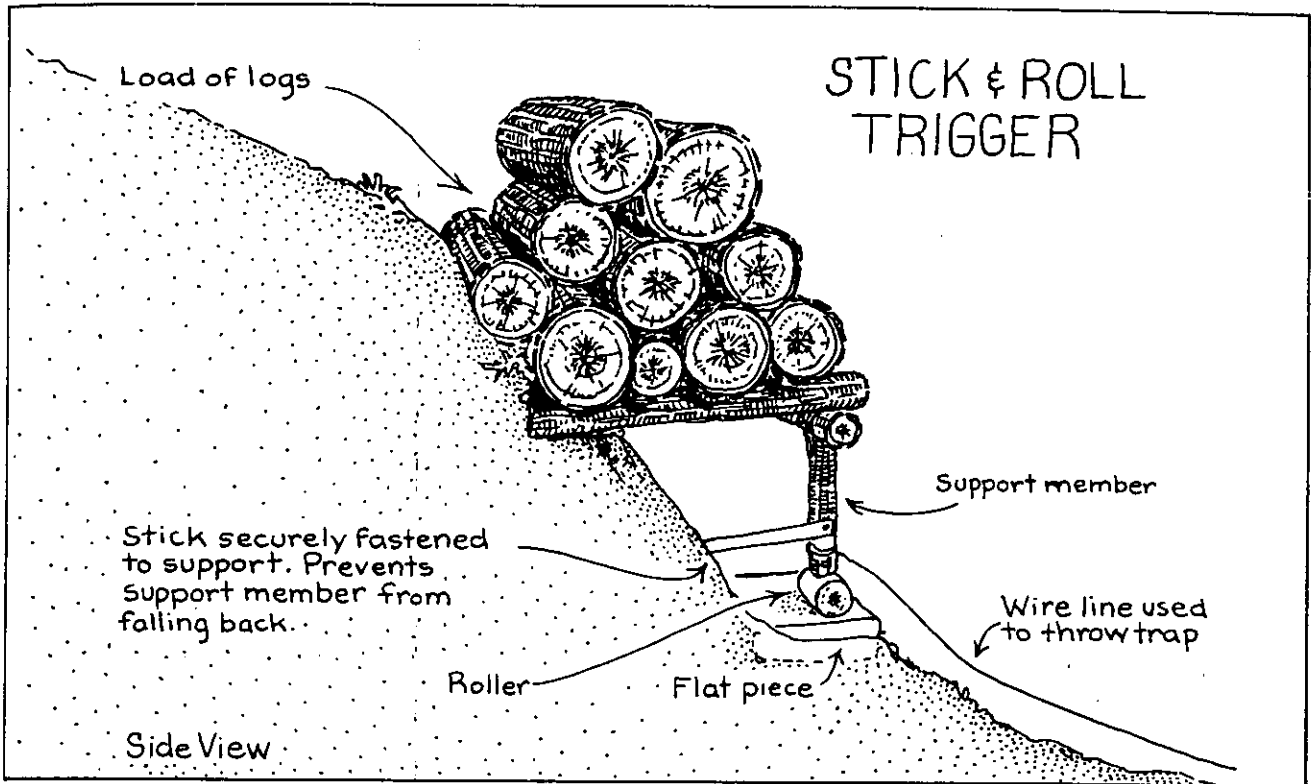

roller. Another very effective method is to grease the roller and the pull stick slightly.

Apply the grease sparingly or you may never get the trigger to hold again.

CHAPTER 4

PIT TRAP

Many people, when they think of a man-trap, visualize a hole in the ground dug in such a way that the enemy falls in and is impaled on stakes or captured. In real life it does not work quite that smoothly. But since this type of trap is the stereotype in people's minds, it is a fitting place to start.

Old hill country trappers know that under most circumstances it is virtually impossible to catch wild animals in a pit trap. This is a fact, in spite of the "Frank Buck, bring-em-back-alive" tales you have heard.

But we are not concerned here with trapping wild animals; men can be caught in a pit. In actual practice, however, it takes a good deal more time and labor to put an effective pit trap into service than most people realize. And then the mantrapper must arrange some special conditions to really get the rig to work well, especially if the targets are people who are woodsmen.

Men on horseback are nearly impossible to pit-trap. The horses will sense the danger and avoid it. On the other hand, motorized vehicles are easy to lure into a pit trap if one is halfway clever about it.

MECHANIZED QUARRY

A small truck or motorcycle has no brain. It cannot determine if it is headed for certain destruction, even if the signs are obvious. The

operator of the vehicle is handicapped by the speed at which the vehicle travels and the distance from the driver's seat to what may be abundant evidence on the road. Another plus for the mantrapper is that operators of vehicles tend to be lulled into a sense of false security. Obviously anyone who lets that happen is likely to find himself in someone else's hole, but it happens all the time.

Since pit traps are so disruptive to the environment, a great deal of attention must be paid to detail when digging them. You will need a relatively large crew of laborers who must be held closely in check, lest they trample every blade of grass and brush within one-hundred meters of the set.

The best approach I have found requires that you stage the workers off of the site fifty to one hundred meters in a carefully prescribed manner. Be sure they know what path to take, where to dump the diggings, and that they cannot spill or trample.

Use lots of mats, canvas, or plastic sheets to protect the site as needed.

PIT TRAP LOCATION

Careful consideration must be given to the location of the set. My preference is to locate the pit in an overgrown detour trail, covered with flattened vegetation and rutted as a result of men and vehicles leaving the road to

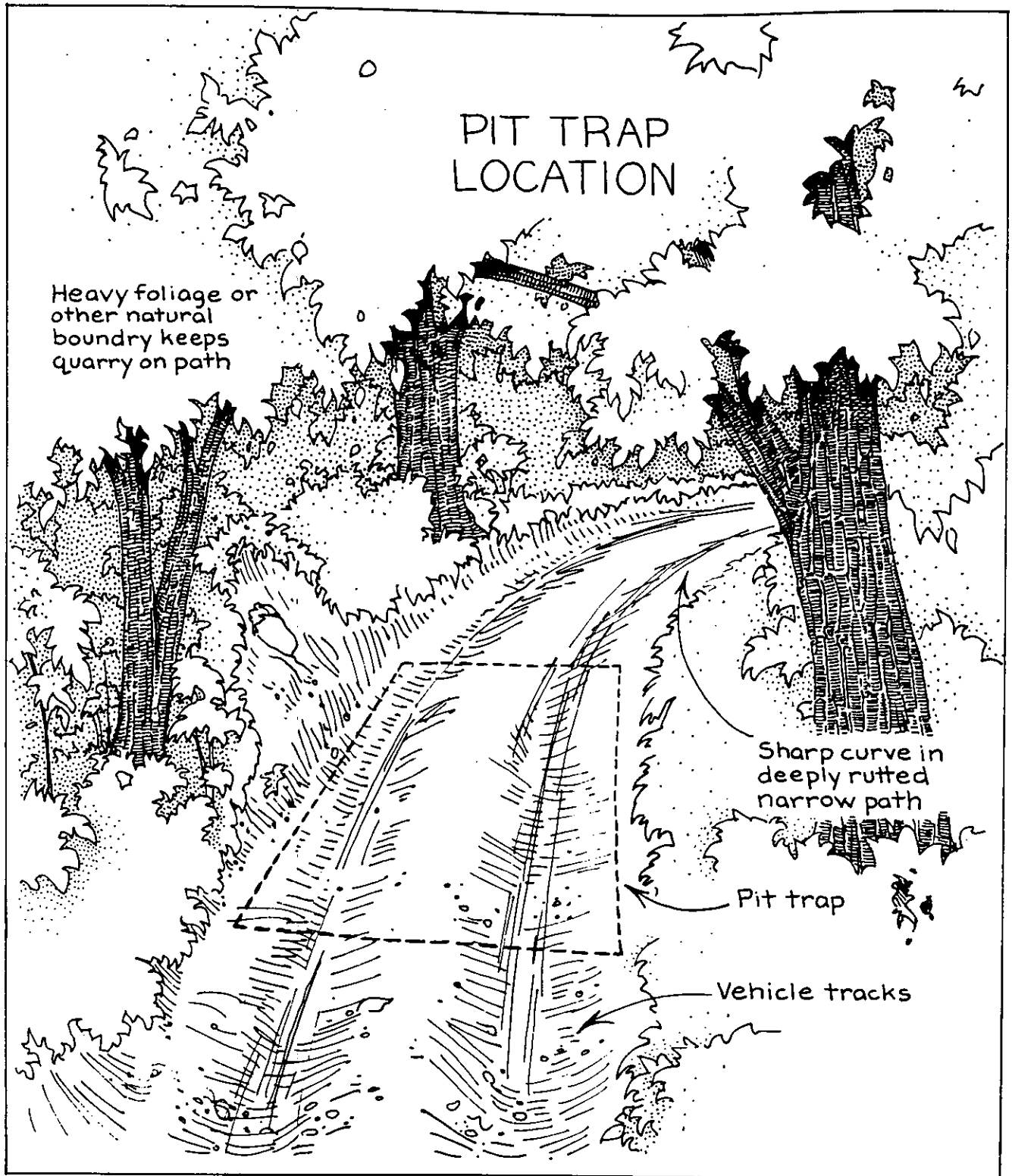

detour around a fallen tree, washout, or other obstacle.

The very best location, in my opinion, is

one where the temporary road or trail leaves the main road for a few dozen meters and then turns sharply back to the main path. The pres-

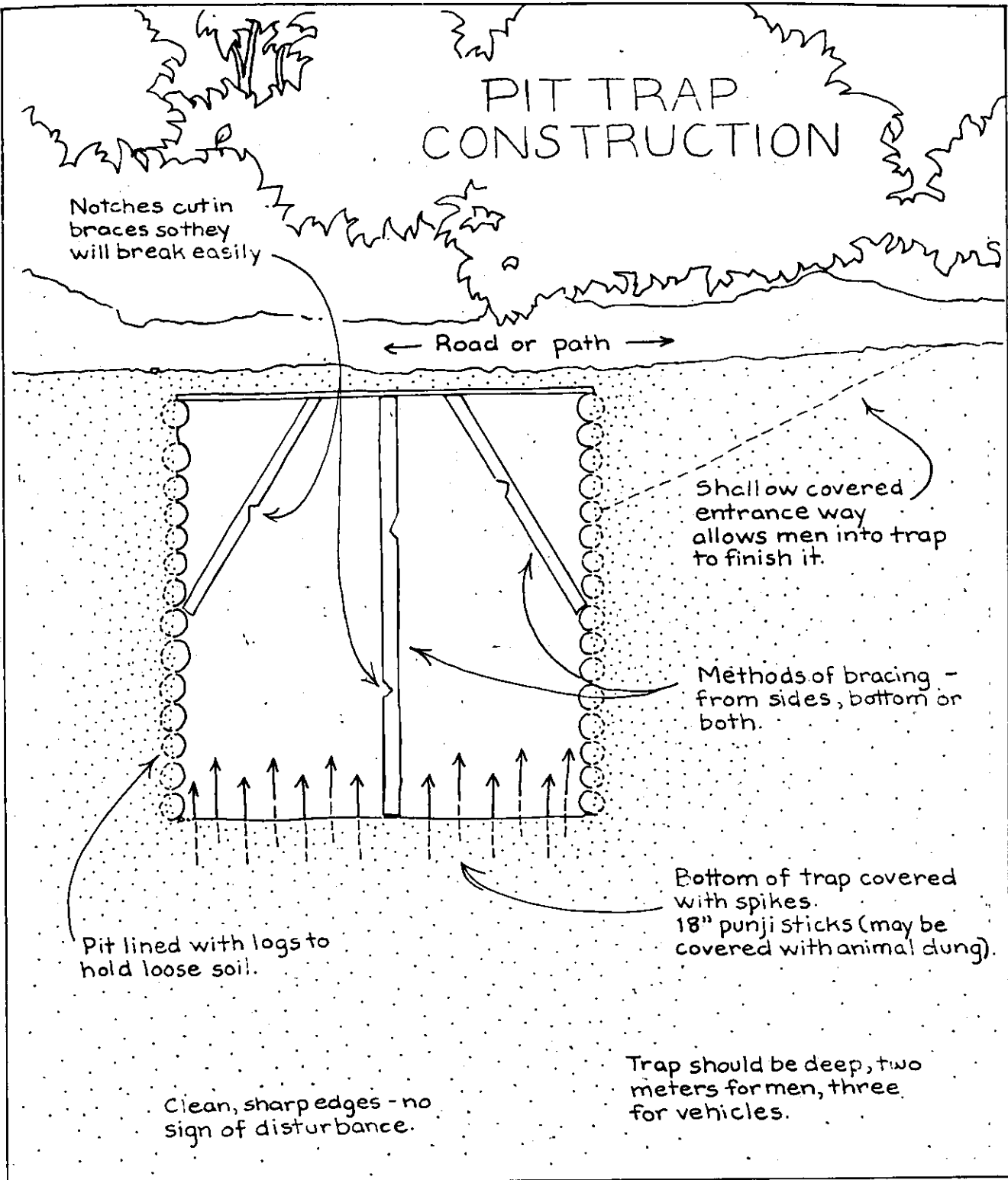

ence of tight, thick undergrowth will make the set work even better.

As the enemy leaves the main road, his

vision will be obscured temporarily. In addition, the high, dense growth on either side of the detour should keep him on the chosen

path. On turning the corner and straightening out for the run to the main road, the victim will relax his vigilance. At that point the trap should be waiting.

Check Soil Type

As with all traps, locations with the correct criteria are not easy to find. Be double-damn sure, for instance, that you check the soil type before starting to dig. Are there large roots to hack through? Will cutting them kill the trees and alert the enemy? Is the soil rocky or swampy? Will the side walls of the trap hold or must they be reinforced with logs?

Keep in mind that pit traps have to be dug very deep: two meters for men and three meters for machines, at a minimum.

Retain Surface Materials

Surface materials should be retained for use in covering the trap. It must appear as though existing wheel ruts or boot prints go right on over the trap with no break in continuity.

The best way to do this is to use Visqueen plastic sheeting. I spread the surface material, which has been carefully removed, out in large chunks on the plastic sheeting. Use three thicknesses for trucks, one for men.

After setting up the entire trap, have several men enter the hole from the side and hold up boards to support the plastic. New tracks can then be made by walking over the supported plastic, or by rolling wheels over it.

Using plastic makes it possible to place puddles over the set.

The Puddle Variation

Sometimes a giant puddle will work to obscure the whole set. Men won't go through if they can avoid the water, but vehicles are suckers for this puddle variation of the pit trap.

First-time pit trappers forget that they have

to do something with the catch after it falls in the hole. Tigers, for instance, are famous for jumping out of traps. People will do likewise.

The only two really effective methods of keeping people in a trap that I have found are to plant punji stakes at the bottom of the pit for men, or flood the pit for a jeep. Theoretically it may be possible to drown troops in a deep hole filled with water, but it's unlikely. I, at least, have never seen it done. The best to hope for is that the vehicle will be damaged enough that it will be abandoned.

IMPORTANCE OF SUPPORT ADJUSTMENT

Adjusting the supports for the cover on the hole is an art. They have to give way crisply when the target crosses, yet hold the top cover nicely until then. I like to either whittle down the supports that hold up the plastic cover, or use a rigid hinged roof held up by a flimsy support on one end. Either method will dump the enemy.

MAINTAINING SECRECY

The single biggest difficulty with pit traps is maintaining their secrecy. If the location is a good one, there is tremendous danger that enemy troops or vehicles will come by before the mantrappers are ready. There is no way to mitigate this problem. It will probably always be a handicap for the mantrapper who wants to use a hole in the earth to catch people.

In most places, a pit trap is not workable. Yet the skilled mantrapper has to keep the pit in mind when deciding which trap will work best in a particular situation. Sometimes that one-in-a-thousand situation occurs and a pit will produce real results. Another time a good working knowledge of the pit trap principle may save your life in the bush.

CHAPTER 5

SHEEPEATER'S ROCKFALL

The Sheepeater Indians at one time inhabited some of the steepest, roughest areas of the western Rockies.

No other tribe wanted to live on this inhospitable terrain, or for that matter, could even scratch a living from it.

According to legend, this small Indian tribe was held in low regard by the more advanced tribes around it.

THE SHEEPEATER LEGEND

Apparently the Sheepeaters were considered to have had limited intelligence and only a rudimentary knowledge of the use of tools. Early anthropologists as well as the other Indians thought of them as dirty, uncouth people who were as much animal as human.

I believe that the Sasquatch legend probably originated with the Sheepeaters. They were the kind of people who could engender such rumors, since they lived in remote squalor and privation where only the mountain sheep, bears, and cougars normally existed.

What few Sheepeaters existed succumbed to smallpox. As far as is known, none survived past the 1880s.

Since the Sheepeaters were very primitive people who never learned to use bows and never acquired firearms, they were often hard-pressed to defend their natural rock territory against outsiders.

Early records are sketchy, but we do know that these little-publicized natives made extensive use of falling boulders to protect their domain. Combined with the rugged terrain and natural seclusion, it was enough to discourage even the most determined intruders from wandering onto their land.

ROCK TRAP PREREQUISITES

Two fairly obvious prerequisites are necessary for the deployment of rock traps: large rocks, and sufficient altitude to make them dangerous. People who live in marshy, wet, flat environments, for instance, had best think of some other mantrap.

For those who will be operating mantraps in steep mountains, there is no easier way of storing up an incredible amount of easily unleashed energy than with the Sheepeaters' Rockfall. At one time I was even involved in a plot to drop a huge boulder on a tank, which I will discuss in "Jack the Tank Killer."

Under normal mountain conditions, a pile of rocks placed above a trail is not easily detected. The trap is one of the less difficult types to put in, since it is easily hidden and 95 percent of the construction activity is away from the path the enemy will be advancing on. It takes a pretty damned shrewd scout to keep his patrol out of a rockfall if it ventures into the mountains in the first place.

SHEEPEATERS' ROCKFALL

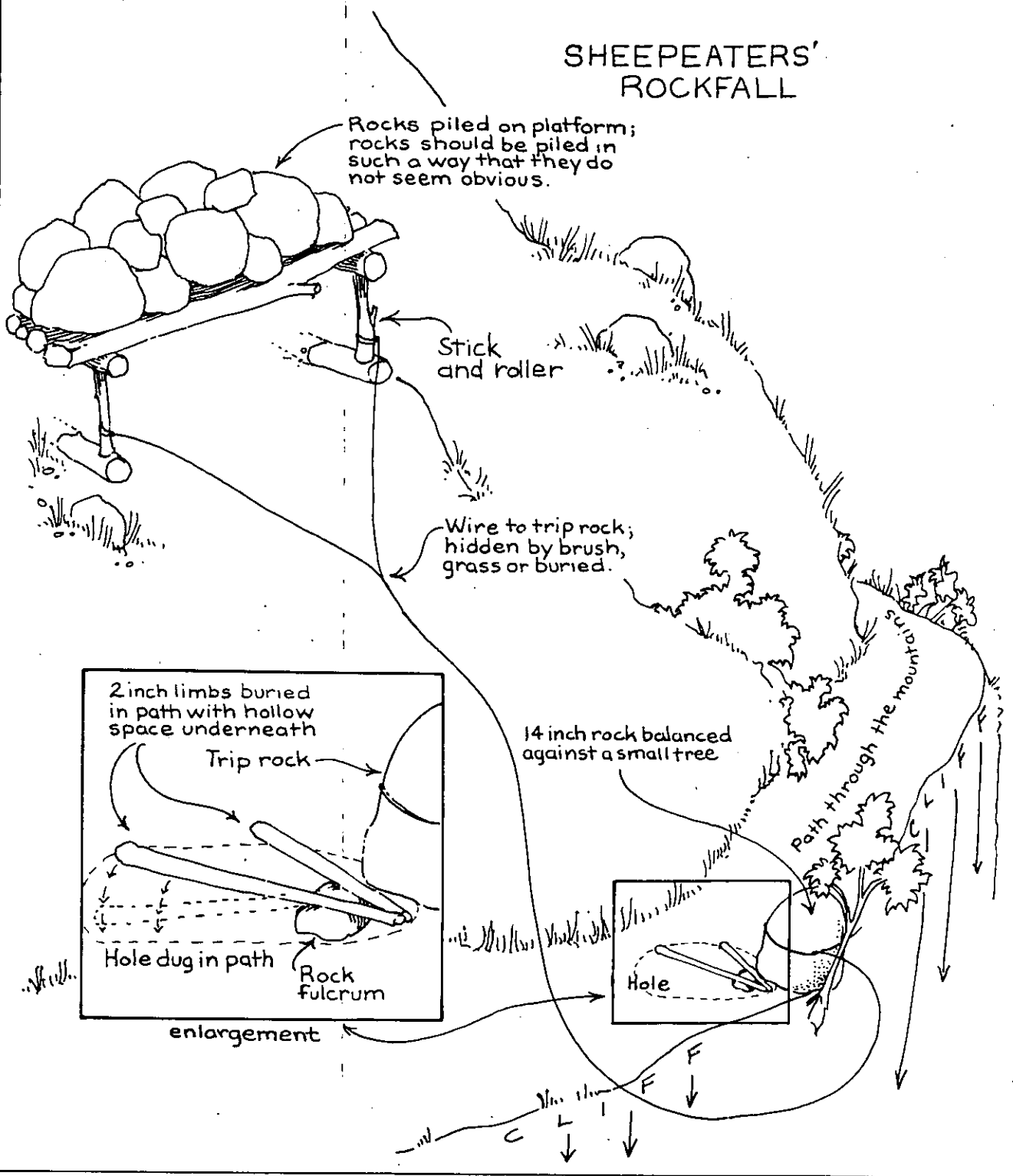

SITE LOCATION

The best place for a rock trap is from 150 to 300 meters above a path that crosses a broad, steeply sloping meadow. There must be at least a 25-percent grade, especially if the rocks are to be dropped from the shorter end of the recommended distance.

Multiple rockfalls made from higher elevations and longer distances tend to disperse as they gain momentum. The rocks begin to skip wildly into the air and will often miss the target. More material can be added to the fall, or the trapper can merely be content with scaring the hell out of the patrol. Of course, if a hit is made under these conditions, it will be an excellent one.

In very steep terrain it is sometimes possible to drop a load of rocks straight down. Usually this situation is a trapper's pipe dream, being virtually nonexistent in real life.

Pick a spot for the rockfall where there are no rock ledges, trees, or other natural barriers behind which the enemy can scurry.

When setting it up, I like to put the rocks on a log platform set into the hillside. When the trigger is hit, the platform will swing down like a hay door on a barn, dumping the rocks in a neat, orderly manner.

LOAD CAPACITY

Using two prop sticks, I have made traps as long as eight meters that have held over 5,000 kilos of rocks. By the time the boulders were 200 meters down the hill, they covered an area 70 meters wide.

The nice feature of this system is that two or three people carrying 40- to 60-kilo rocks can get a really lethal mantrap together in a very short order.

The main drawback to this type of trap is that usually the workers making the set are right out in plain view for God and everyone else to see. You can get around this by building it at night or picking a location in a canyon where the view is restricted.

TRIGGER WIRE IS NECESSARY

Another problem involves the availability of wire to trip the triggers. If it is completely impossible to acquire several hundred meters of heavy wire, constructing a rockfall is probably not a feasible idea. The best trigger for this type setup is a couple of good, stout sticks and rollers, triggered by a 40-centimeter rolling stone. Rope running from the stone to the main trigger is not strong enough and is too obvious. It is imperative that number 12 or 14 wire be available for this purpose here.

Trigger the rock with two 5-centimeter limbs buried in the path. These limbs serve as levers. Be sure the wire attached to the rock has enough slack to allow the rock to get some momentum before snubbing the wire tight on the stick and roller trigger. This is accomplished quite easily by hiding the surplus wire.

Be sure to take into account the delay factor when setting up a rockfall. It takes what seems like four years between the time someone hits the trigger till the rocks arrive on target. It is possible for the quarry to walk right out of the kill zone, since the time lag is so extensive.

Besides setting rocks on a platform, one can prop one big boulder on edge, with smaller rocks propped against it, holding it in place. Usually it is impossible to get enough sizeable rocks to fall at one time with this system to be of much value.

If you know that your area will be patrolled by large numbers of men, you might consider setting up a series of rock traps. It is possible to tie them together so that any one of three triggers will pull down a slide that in turn will pull down six or eight more. I have never tried this approach, but am sure that under the right circumstances it would be a real winner.

Guerrilla leaders with lots of able bodies might consider putting them to work on a multiple rockfall of this nature. It would be a good way to keep the troops busy, and the trap could very well protect one's back door approach into an area, or at least signal the approach of the enemy.

Be sure when setting the trigger for the

Sheepaters' Rockfall and when loading the stones that you use safety poles. It is easy to misjudge the load capacity of a trigger, send-

ing a ton of rocks down on you and endangering the lives of friendly natives who might be down below.

CHAPTER 6

CUBAN WATER TRAP

In 1956, I had the opportunity to spend seven months in prerevolutionary Cuba. Batista was still firmly in control at the time, but the Castro brothers were active enough to make life interesting for a young mercenary.

One of my duties, in keeping with my cover as a gringo tourist, was to take an interest in caves. Cuba has a great number of caves. Before 1960, some were actually developed as tourist attractions. Others were just holes in the ground where the revolutionaries stockpiled propaganda posters, among other things.

Our little saga started on the beaches of Veradero, where I lolled around watching girls and spearing fish. Great numbers of 28- to 40-foot fishing boats plied these waters. Most, I was told, came from Miami.

I noticed that whenever the state military beach patrol was out of sight, some of the boats would quickly offload olive-drab (OD) green boxes into small skiffs that ferried the boxes ashore. Once on shore, the suspicious wooden boxes disappeared, never to be seen again. At least I never saw them again.

Every so often a contact named Armando appeared, who looked like an ill-kempt campesino. Armando would whisk me off on a three- or four-day swing around the island to inspect various caves. It seemed like every cave inspection required a five-kilometer hike in the stifling jungle heat.

But I dutifully went on these assignments in anticipation of the fish-spearing activity that would come later.

After several months of this mucking about, it didn't take much genius to conclude that the best deal was back on the beach inspecting swimming suits. For that reason, I never philosophized a great deal about the cave portion of the business.

A UNIQUE MANTRAP

But my jungle forays did provide me with opportunities, on several occasions, to analyze an ingenious mantrap that is probably indigenous only to Cuba. I doubt seriously if it is used any other place in the world. Probably the set is not even used in Cuba any longer. Other than my knowledge of it, it may be lost to history. I call it the Cuban Water Trap.

My first introduction to this trap came on my fifth or sixth visit to one particularly grungy cave about 120 clicks from Havana. The same dirty little unshaved Cuban, Armando, was showing me around the dank hole in his typical bored fashion, when the power went out in his two-cell flashlight.

Rather than sit around waiting, I started climbing up toward a light I could see in the distance. Armando chattered away nervously and followed along. At this point in my Cuban

CUBAN WATER TRAP

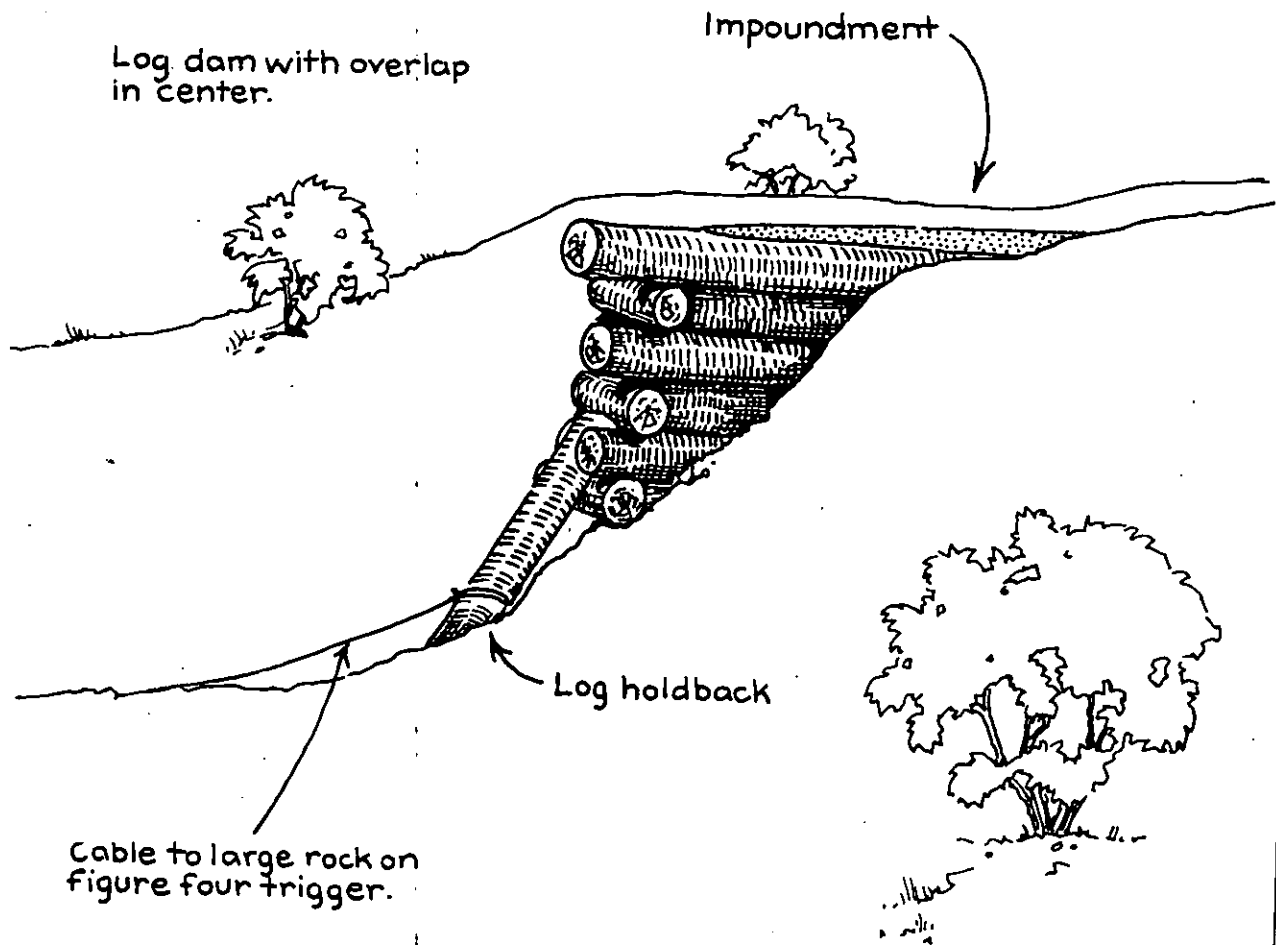

career, I could understand about half of what he was saying.

Eventually we emerged high on a lush,

green hillside. Vines and grass partially covered what was actually quite a large hole exiting the cave. The valley floor lay below us

about 200 meters. I could see the creek but not the trail or the cave entrance, which was skillfully hidden in the undergrowth.

To my right, about halfway down the hill, lay what looked like a fairly good-sized reservoir. Enough brush obscured the view that it was impossible to tell for sure. Armando noted my interest in the curious reservoir. My little guide, now alert for the first time since I met him several months back, waved for me to follow him down the slope.

The pond he showed me was approximately one hectare in size and fairly deep. I don't know exactly how much water was in the impoundment, but it seemed like quite a bit.

Feeding the pool was a creek that ran down the valley. The dam holding back the reservoir was constructed within a grove of trees. It was made entirely of 20- to 50-centimeter logs filled in with brush, vines, and moss.

Below the dam, water escaped through cracks and holes, cascading noisily down till it ran into the creek again. No water spilled over the top. I wondered what would happen if a sudden cloud-burst, a common occurrence in Cuba, sent extra water surging down the creek into the pond. Apparently the dam could take it.

Green scum hung over the barrier logs like a blanket. It looked to me like the whole rotting mess was about to collapse any minute. My guide took me around perilously close to the front of the dam. From there I could see the logs laced together like fingers. The ends bowed out, pointing downstream at a shallow angle.

Two log braces were set against the middle of the barrier, like stick and roller triggers holding back a rockfall. It was obvious that they were all that was holding the contraption together.

Smiling like an American politician on election day, Armando pulled a piece of wire cable out of the grass and showed me where it was attached to the two log braces. Carefully, he hid it back in the grass again. We continued our stroll down the trail, past the main entrance of the cave. Here the trail snaked on through dense undergrowth.

Off to the side, not 20 meters below the cave, was a large, round rock every bit of one meter in diameter. It lay there, obscured by brush, propped up by a figure four trigger. Gingerly my guide showed me its horizontal trip stick hidden in the path.

In a series of grunts, motions, and a little Spanish, he explained that the trigger tripped the rock which was then dumped into a two-meter-long chute. At the end of the chute, the rock pulled the cable tight, snapping the two braces away from the dam. In theory, anyway, the water would come cascading down the little valley, washing away all men and vehicles unfortunate enough to be in the way.

WATER-TRAP OPERATIONAL PRINCIPLES

Later I asked Armando, who spoke perfect English when he wanted to, about the setup. He claimed the trap really worked. Any Batistas coming up the trail would trigger the device, creating what seemed like a natural disaster. Armando claimed the revolutionaries always tried to put their caches in caves in this type of valley. He said they could protect the cache that way without raising suspicions.

I asked if a trap like this had ever been hit by the Batistas and was told yes. "The logs tumbling in the water are deadly," he said. "Inside the cave there is some water, but most goes on down the valley. It is very effective," he claimed.

In this case I really don't know if he was telling the truth. I do know that, in the course of my travels, I was able to confirm the existence of at least two other Cuban Water Trap reservoirs.

This mantrap's concept is ingenious, but obviously there are problems. The set has to be viewed as a special-case situation, more so than any other system in this book.

SITE LOCATION

Valleys in which a water trap can be con-

structed must be small with fairly steep side walls. Obviously a steady, nonseasonal stream has to flow down through the bottom of the valley. Small trees and underbrush that can hide the pond, trail, and trap rigging are important. On the other hand, the cover cannot be too dense or the trees too tall, lest they break the flow of the water and logs when the dam gives way.

Part of the destructive force of the trap comes from the logs and debris tumbled along with the water. From my point of view, the logs in the dams I saw looked rotted and soft. This may have been illusionary. They did manage to hold back a pond about four meters deep. Nevertheless, one had best make certain that suitable building materials are on hand for a project of this scope.

Constructing a suitable trigger would seem to be a monumental problem here. I often wondered how the trapper could tell what size of brace was sufficient to hold the dam back

before the pond actually filled. If it looked weak, the mantrapper could open a hole and drain the pond. If it broke, it might be possible to start over.

TRIGGER SYSTEM RECOMMENDATIONS

The trigger system itself does not seem unduly complex. After thinking about it off and on for almost twenty-five years, I have concluded that I would, if ever called on to make a trap of this sort, also use a large boulder with figure four trigger to pull a cable which, in turn, would yank out the dam braces.

Constructing a Cuban Water Trap is nine-tenths art and one-tenth luck. I am not even absolutely sure it would work as planned, my friend's assurances notwithstanding.

Yet it is an interesting mantrap. I am sure the idea merits application someplace in the world today.

CHAPTER 7

SPIKE TRAP

The age-old Spike Trap has been used to deter both man and beast. I once came across a photograph of a device made to mantrap poachers, constructed about 1650 by an English blacksmith. But whether the trap is intended for two- or four-legged animals, the design is alive and well today, used by a number of different bush native societies to guard their home territories.

Spike Traps are particularly effective for use against horses. Perhaps because I am an old duffer who was raised around horses, I still respect and believe in them.

They are as good a means of transportation for some military forces under many irregular guerrilla-type situations as will ever be found.

EXCELLENT CAVALRY APPLICATION

Because I perceive horse-mounted troops to be a threat to me, I have probably spent more time than the average irregular soldier trying to figure out how to handle them. In that respect, the Spike Trap is the answer to a maiden's prayer. Properly set, one trap can do in 5 percent of a company's horses every time they patrol the defended territory.

A Spike Trap can be set any place a 1-meter hole with 25-centimeter sides can be dug—in trails, at river crossings (it doesn't matter if the trap fills with water), in open fields, or wherever. In some places the trap

can be rigged, left six months, and still produce a catch.

SPIKE TRAP CONSTRUCTION

Although actually installing the trap is not difficult, preparing the unit is time-consuming. If the objective involves setting traps in batches of at least fifty, the only practical approach is establishing a small production facility to make trap bodies.

Under most circumstances the trap bodies should be 25 to 30 centimeters on a side. The traps don't have to be square, yet in most places square construction materials are the easiest to scrounge. Use wood, metal, cast iron, pipe, or anything else handy—don't overlook 20- to 25-centimeter pipe. Use a box, from 70 to 100 centimeters long. My experience is that the trap works best if the victim has trouble finding the bottom. Of course, it isn't practical to build a trap that would swallow an entire horse leg. But put a human up to his thigh in a Spike Trap and you have something.

No matter what the side walls of the trap are made of, they should be tough enough to hold the spikes without bending. My personal preference is 16-gauge tin. Material of this sort can be obtained, bent, and soldered just about anywhere in the world.

The spikes must be fairly tough. Twenty-

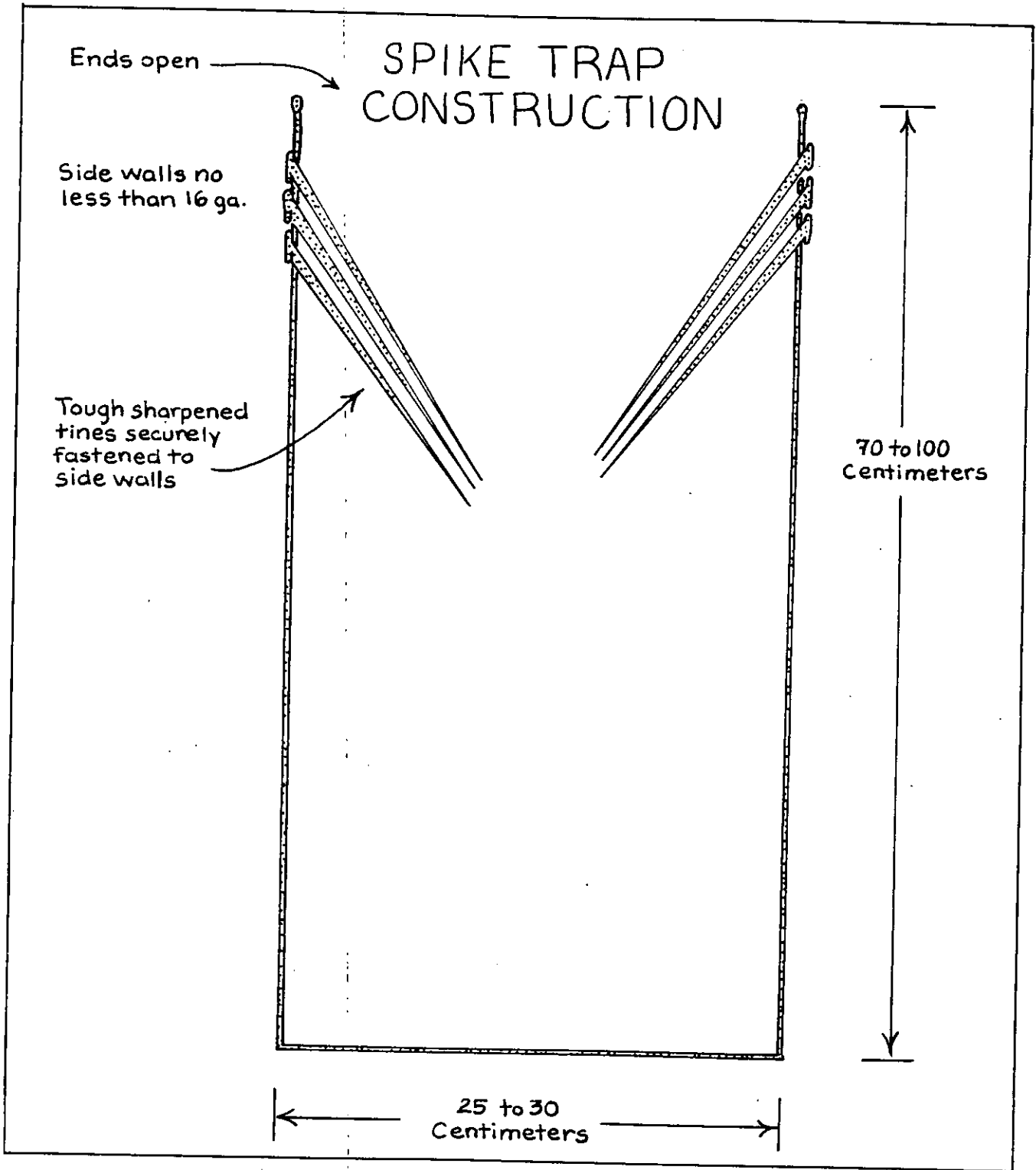

penny nails, or an equivalent size, are as small as one should consider using. Or make the spikes out of steel rod, slivers of

heavy sheet steel, old bedsprings, and other similar junk. Make certain that the ends are needle sharp.

SPIKE TRAP PLACEMENT

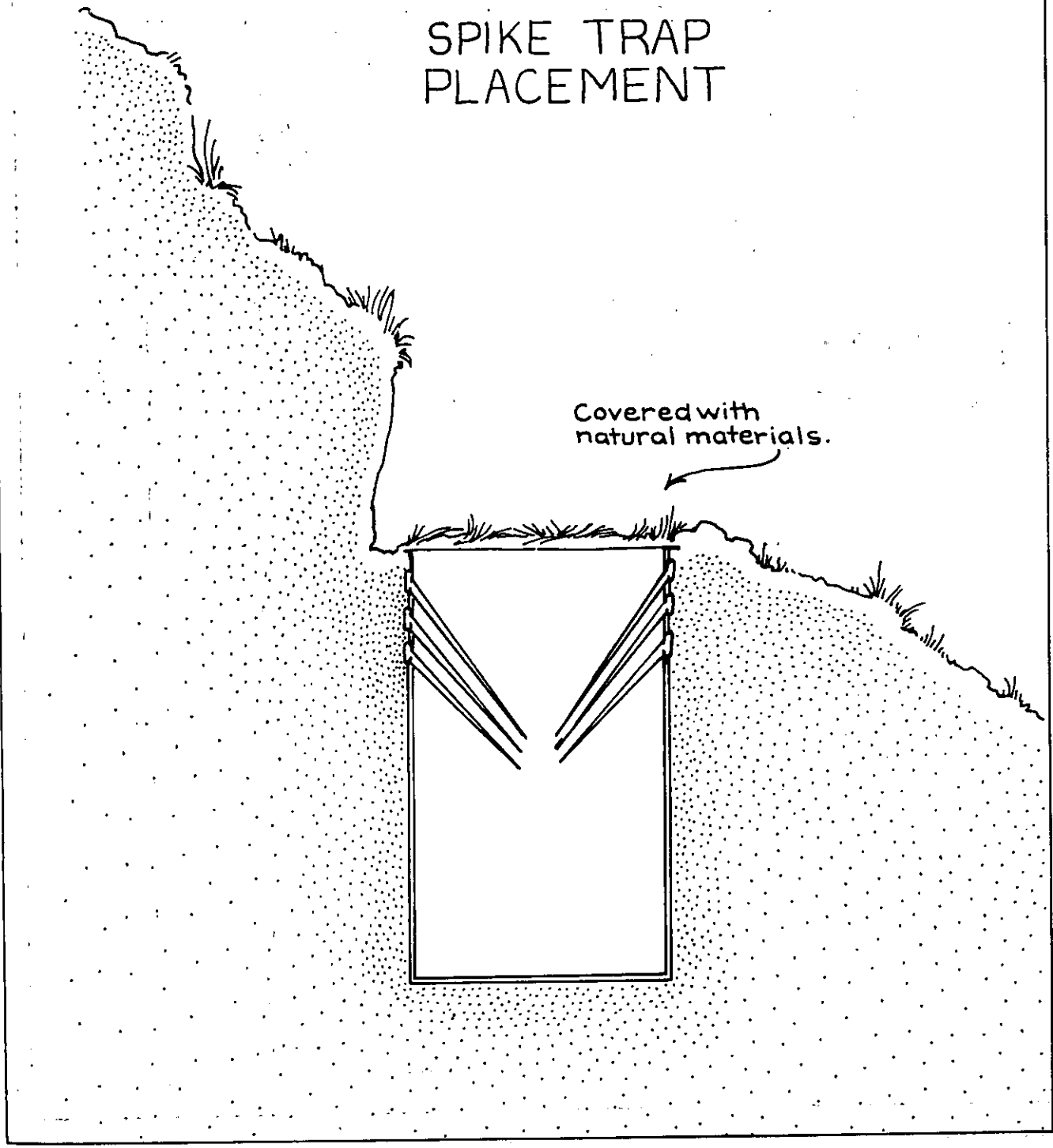

Securely mount three spikes on one side and two on the other, not more than 3 centimeters down from the top of the box. Bend

the spikes toward the bottom on an approximate 30-degree angle into the box. When completed, the opposing sets should have a

gap of about 7.5 centimeters. There must be a significant slope down to the spikes.

Carefully dig the boxes into the ground. Carry away all the surplus soil. Covering can be made with anything that does not arouse suspicion. On a dry, dusty path try a leaf or piece of paper covered with dirt. On one occasion I used pieces of sod, but after a week or ten days, the grass dried out. Every set was extremely conspicuous and had to be recovered.

Spike Traps may be placed at the bottom of a small incline or at the top of a hill, places where the quarry is likely to step down harder than normal. Horse traps should be placed where the horses will go. If the trap is well covered, the critter won't spot it.

Once any portion of a foot passes the bottom of the spikes, the quarry is had. After they gain experience with this type of trap, humans will kneel down, lean on their rifle, or pull on a branch to keep from going in farther. But most of the time the quarry will sink deeper and deeper, the nails digging in progressively. Sometimes the trapee will manage to remove

his shoe and escape. Escaping is tougher if the trapped person had a pack on and was tired when he lost his footing.

Invariably, horses that get a foot in one of these traps thrash around and break a leg.

PSYCH OP ADVANTAGE

Of all the mantraps described in this book, the Spike Trap is probably the least lethal. Its advantage lies in the wound it produces, which will cripple a man for a few weeks, and in the confusion and consternation caused when someone gets trapped. Especially at night, the results are dramatic. The entire patrol usually will stop. Several men will have to unearth the trap and break it apart noisily while everybody else stands around contemplating their exposed position.

Possibly the trap can be made more lethal by covering the spikes with snake venom, nicotine sulfate, or some other poison. That's a matter of personal preference.

CHAPTER 8

JUNGLE SNARE

Certainly everyone will agree that any book on mantrapping has to have a section on snaring folks by the foot and simultaneously springing them up into a tree. Everybody knows from watching forty-year-old John Wayne and Tarzan movies that this is how it should be done.

In real life, a spring-loaded Jungle Snare is a viable mantrap. A snare works well anywhere there are trees with a trail through them, some ground cover including a few bushes, and an enemy that will venture into the area.

A good snare set is simple enough to build, yet incredibly tough to avoid. About the only people who can consistently stay out of such snares are natives who live very close to the earth. They tend to walk by placing their feet up and down. We shufflers, inhabitants of modern and developing civilizations, don't have a prayer. By the time we feel the snare pull on our foot, it is too late.

SNARE CONSTRUCTION

There are literally dozens of different methods of setting very good, very effective jungle snares. Some are absolutely ingenious. However, most of the ingenuity is related to producing a mortality, rather than getting the victim into the set in the first place.

First things first—here's how to get the snare on the enemy's foot. Construct the snare

out of 20-millimeter airplane cable or any other light wire that will withstand a jerk load of 300 kilos. Number 16 copper appliance wire qualifies; baling wire or regular deer snare material will do the trick, too.

The loop should be about 30 centimeters in diameter. If the snare is too small, it trips before the target's foot is completely trapped. The snare simply pulls a boot or slips off the foot.

Leave some slack—perhaps 10 centimeters—in the wire. Lightly anchor the bottom of the loop right to the ground. Make sure it stands up perpendicular to the path. I like to tie up the snare loop with a single blade of dry grass.

CAMOUFLAGING THE SNARE

Unless the snare is to be used only against night patrols, another precaution must be taken. It must be hidden from view. The best way to hide the snare is to make the set where a branch or bush overhangs the trail at a height of about 1 meter. The enemy will see the branch as a light obstacle that he can push aside. But he won't be able to see the ground and/or the snare. A few weeds or some other foliage in the path will help obscure the wire.

COUNTERWEIGHT INSTRUCTIONS

Set the wire up to the right or left in the path. People don't have feet in the middle.

TRADITIONAL JUNGLE SNARE

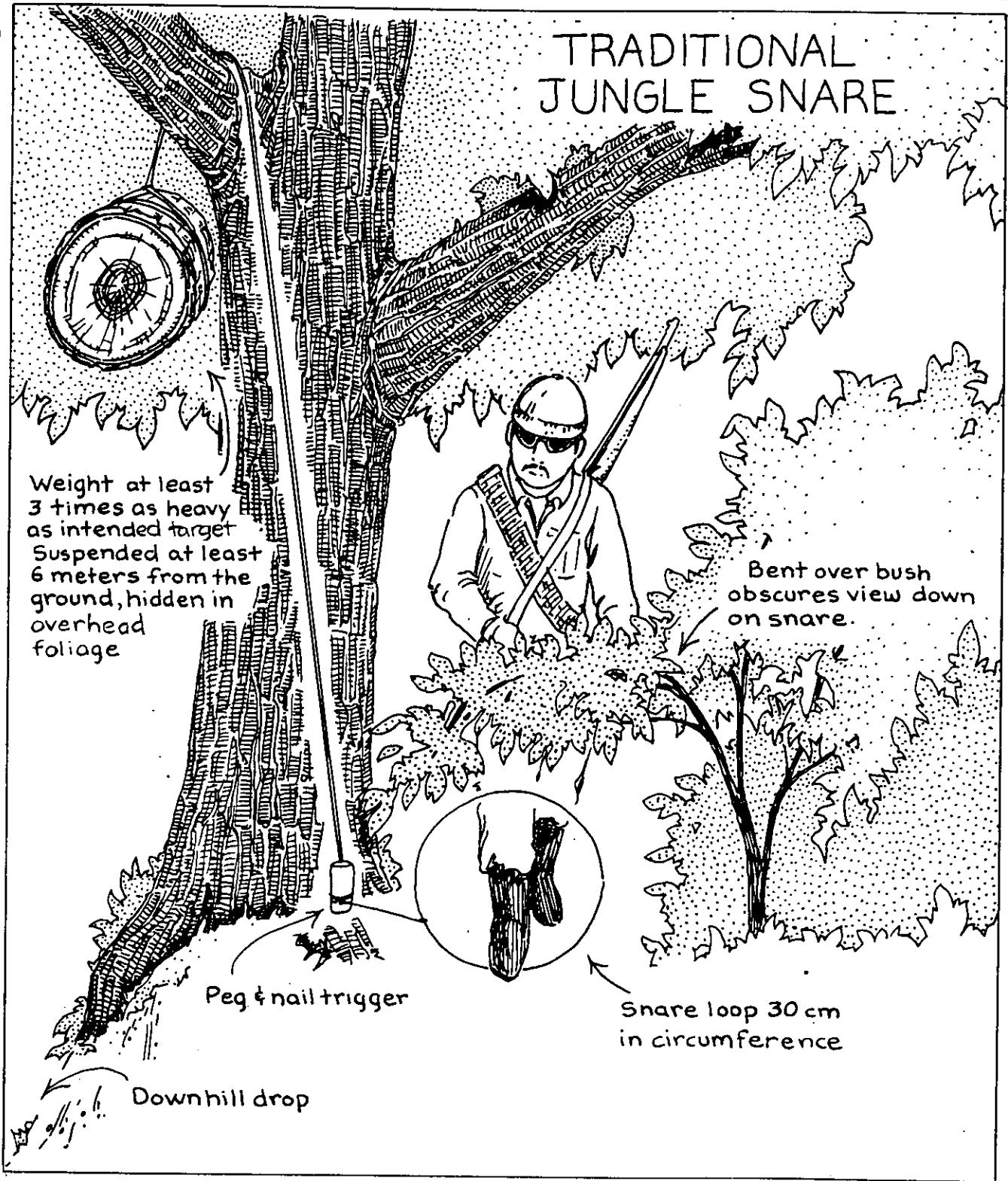

Use a peg and nail trigger as described in the chapter on triggers.
Hanging some poor guy temporarily in a

tree is one thing. Producing a casualty is another matter. Here is how I recommend doing the quarry in, once he is in the snare.

Building and Keeping Your Arsenal Secure

Hoist a 250-kilo log or stone up a tree by throwing the snare wire over a stout limb. Position the weight at least 6 meters high. Run the line up behind the tree trunk and hide it from view as much as possible. It sometimes works to suspend the log or stone behind the tree. Just be sure the hoisting path is not obstructed by large branches.

When the trigger is tripped, there should be enough weight to jerk the victim off the ground and pull him high into the tree.

Tacking a piece of tin on the limb over which the snare wire runs will smooth the operation considerably.

It is possible to produce a fatality using this method without resorting to strapping scores of spikes in the tree or other similarly difficult

procedures. Picking the trap location becomes crucial for this operation. Locate a tree on a raised bank alongside the path. If the weight drops farther than the victim is raised, it will drag him over the limb. He will seriously break a leg, at the minimum.

Things to remember with a trap of this sort include using a strong enough wire, hidden from view, on a well-traveled path. Drop a load at least three times the weight of your intended target. Doubling a wire over a limb halves the weight that can be lifted. Drop the log as far as possible, dragging the victim over the support limb, if possible.

The Jungle Snare is a good device to add to your bag of tricks. The orthopedic surgeons in the area will love you dearly for using it.

CHAPTER 9

JACK THE TANK KILLER

A friend of mine is one of the truly outstanding mantrappers still alive today. With him, I was involved in a wildly ambitious trapping program.

This expert mantrapper was born in Kenya, East Africa, to Americanized parents also born in Kenya. His parents were what are known as second-generation missionaries. He was a lad of seventeen when the Mau Mau uprising started in Kenya. Robert Ruark may have referred to him in his book *Something of Value*.

A MAU MAU RECOLLECTION

I spent scores of nights sitting in a rondaavel listening to my friend's incredible tales about the methods and devices his band of young European counter guerrillas used to keep the lid on the Mau Maus till the British Army arrived. By using long-distance patrols to stage vicious punitive raids, they instilled so much fear into the hearts of the enemy tribesmen they were able to limit their fatalities to fewer than eighty persons. And that's a feat no man would have thought possible when Mau Mau first flared up.

One account is still as vivid as the night he told it. That night, eight or ten of us were gathered around a small campfire—a roll of toilet paper soaked in gasoline. We were camped in the NFD area of Kenya on the Somali border. The Somali Shifta were the

only native troops I ever encountered that constituted anything like a threat. Therefore tension was high as he told the tale. "We used some Somalis one time to clean up a band of Mau Maus," the trapper started. "The group was holed up in some deep brush up north of Thompson Falls. Five of us got up on one end. About a mile away our group of Somalis—maybe eight or ten—started in up the open valley. They were out of sight for maybe forty-five minutes when we heard a few shots. Maybe twenty minutes later the Wogs started breaking cover, running up the valley past us.

"We waited till about two-thirds had passed and then opened up. I knocked one down at about 300 yards with an American grease gun. He was the only guy that lived. Had a great bruise on his back where the slug hit him, but it didn't penetrate at that range.

"The Somalis tracked down every one we didn't get, ending the troubles in that area.

"I always thought it was like driving white-tail deer in North America," he concluded.

My friend is married now, living in the mid-western United States. For that reason, he will remain anonymous.

We operated together up on the Sudanese border during the time when the feuding between the Christians and the Moslems grew really intense. Kenya, Uganda, and Ethiopia come together in what seems on a map like

just a small speck of territory. On the ground the terrain alternates between rough, craggy mountains and stinking rotten lowland. The lay of the land made for tough trekking. For example, it took us several weeks just to traverse the short distance across the Kenya-Sudan frontier.

We operated in good shape for several months in Sudan. The Somali Shifta in the area were our friends. With this group on our side, there was no real danger other than from snakes, mosquitoes, and perhaps an occasional leopard.

As is typical throughout Africa, the Bantu were lazy, unimaginative, and fearful. I never met one who could track or shoot much better than the average North American sport hunter.

Roads in that section of the world are beyond belief. Yet one day an armored personnel carrier loaded with soldiers came clanking around a mountain trail. According to the local gossip, the central government bought the outfit from Egypt and drove it south as a deterrent to our activities.

Every day thereafter, when the carrier would run, the local police drove it out in search of our little group. The noise was so great there was little danger of being surprised by it. On the other hand, we didn't dare expose ourselves for fear of running amuck of the heavy machine gun the rusty old tin can carried.

We resisted the temptation to snipe a couple of soldiers off the rear.

After a month or so of the APC's random, unchallenged coming and going, a change came over my friend, the mantrapper. He decided to get that son-of-a-bitchin' machine.

TANK TRAP CONSTRUCTION

After a long and detailed search, we located a large rock about 3 meters in diameter two-thirds exposed on a steep hillside. A path wound around the hill, perhaps 500 meters below. Although the APC never traveled that road, the way was navigable.

Carefully, ever so carefully, we dug into the

hill until we had excavated the rock, shoring as we went. By the time we completed excavation, all that was supporting that very large boulder was one stout beam.

In the meantime, I managed to collect enough old 1-centimeter cable to reach from the trail below to the rock support beam above.

It took four men almost a week to haul all that rusty, trashy wire rope to the set. We cut our hands and shoulders badly on the frayed rope ends.

During all this time my friend worked on the hill removing stones, smoothing bumps, and calculating the trajectory of the rock. He made small adjustments on the support under the rock, supposedly ensuring that its fall would be pinpoint-accurate.

SPECIAL TRIGGER FOR ARMORED VEHICLES

The trigger for this monstrosity was, in my opinion, cleverly constructed. We brought in a log about 6 meters long, all of 50 centimeters through the butt. With much effort we balanced the log on end behind a large rock palisade next to the road.

Being ever so careful, we wedged rocks between the rock column and the log till it was precariously balanced on end. The log could fall outward down the slope, but not inward toward the mountain.

I connected the cable to this trigger log, leaving about 2 meters of slack, and buried it under loose earth.

A few days later we lit a fire at the end of the trail. When the fire was going strong, I threw three old tires on the flames to produce some black, greasy smoke. Sure enough, within a short time the APC came rumbling out to investigate.

The carrier turned at the fork and crawled up the side trail where Jack's Tank Trap was set. We scrambled up the hill to get away.

Out of respect for the machine gun, we stayed out of sight in a little draw. However, it was possible to watch the cable tighten and

ARMORED PERSONNEL CARRIER TRAP

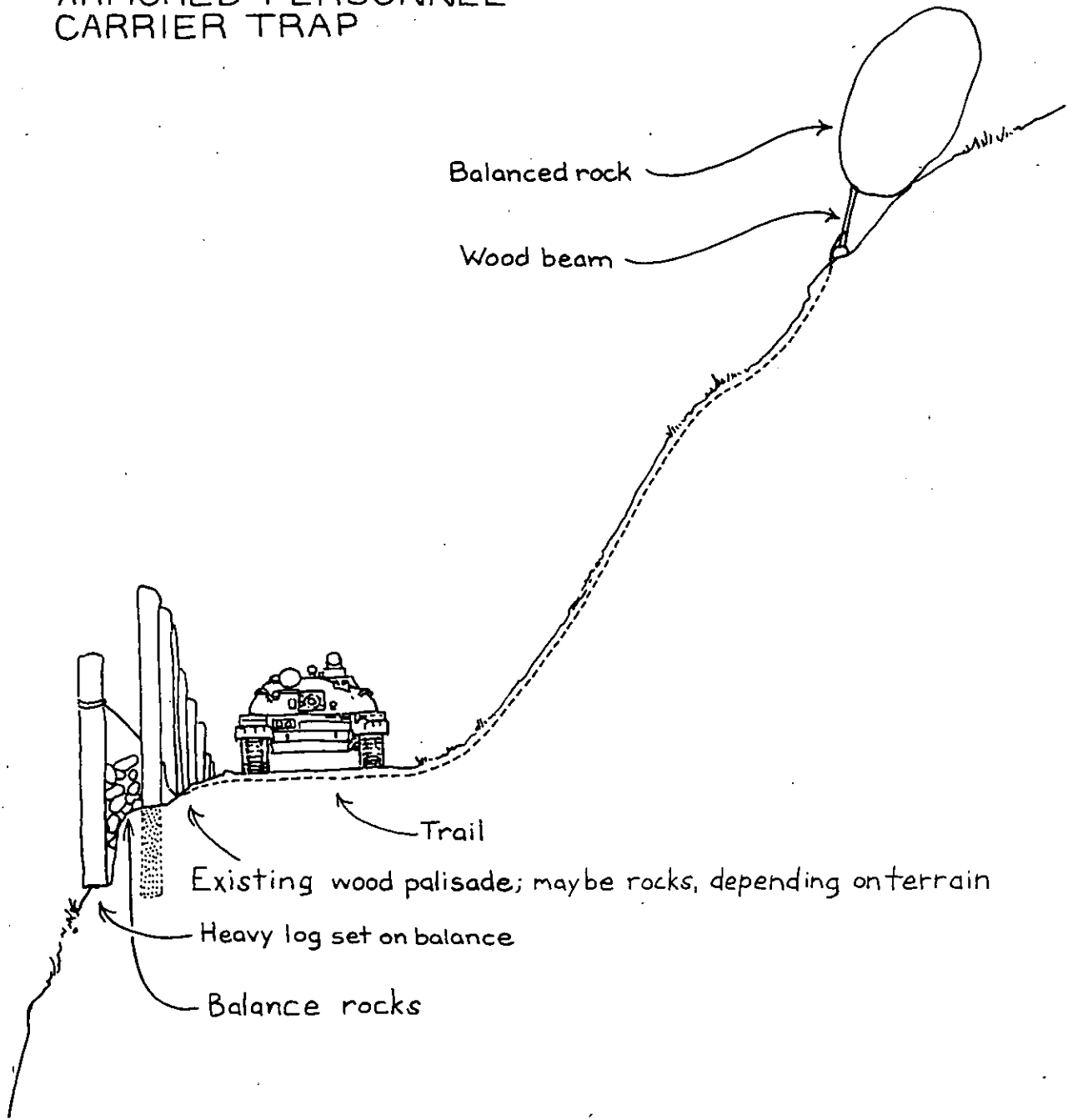

the wood beam snap out from under the huge boulder above.

As planned, the vibration from the crawling APC had upset the precariously balanced log. As

it fell, the log gave the cable a sharp, hard pull, yanking the wood beam from under the rock.

With no shoring to stop it now, the rock started to roll. Moving slowly and ponderously at first, the rock continued to gather momentum till it rolled out of our sight below.

We heard it hit several times on its way down the mountainside. Soon thereafter, the APC crew opened up with the heavy machine gun and several rifles shooting at the place where the rock had perched.

Next day we returned to the trap site for a look. The rock had hit the path, but missed the APC. From the appearance of the tracks, the rock fell in front of the machine. Just how close it fell, we never discovered. The hole mark in the ground was huge—fully 1 meter deep by 3 meters across. Although the monster wasn't killed, it was scared off. When we left the region ten weeks later, the tank still hadn't dared to venture back onto that mountain. With that result, the operation was a success.

CHAPTER 10

INTRODUCTION

Federally licensed dealers in destructive devices report that there is a tremendous resurgence of interest in large-bore mortar and grenade-launcher-type weapons throughout the United States. Interest in these firearms peaked once before, just prior to the 1968 gun act that made it tough to own and operate military weapons.

Even at steep \$1,000-per-year license fees, the number of legal dealers has increased dramatically as well. As recently as two years ago, there were only a couple throughout this country. Now there are scores and scores of dealers willing and able to sell mortars, cannons, and grenade launchers legally.

Things are also changing out on the shooting range. Owners who once unlimbered their .50-caliber machine guns expecting large, appreciative audiences are coming up short. Interest at military shoots now centers around M79s, M203s, and the likes of the occasional 37mm Bofors cannon. There is almost universal agreement that the cutting edge of firearms one-upmanship has shifted to the spectacular big bores. Owners and spectators alike are fascinated with arms that deliver a round on target in a colorful manner, and eight ounces of high explosive thumping resolutely is colorful.

During the 1970s and 1980s, military weapons designers did all of us a favor when they came up with the 40mm system. Instead of dealing with 40,000 psi (pounds per square

inch) chamber pressures, as is true with most rifles, or even 10,000 psi that most shotguns produce, we apply a relatively benign 2,600 psi when discharging an M79 or M203 round. At these chamber pressures, modest and easily available common steel parts work perfectly for constructing homemade firing devices.

By nature, the devices are relatively easy to make in one's home workshop. As if this were not enough, the military has gone and redesigned the cartridges so that they are extremely easy to reload. Whereas 40mm rounds were originally designed using difficult-to-prime high- and low-pressure chambers, they are now set up so that all that is required to recharge the case is a .38 blank. It is best if these are reloaded at home, but even this requirement is not written in stone.

Reloadable 40mm plastic cases come as close to being universally available as any exotic large-bore in existence. It would be almost impossible, for instance, to find empty 25mm Peteaux brass, or 37mm, or virtually any of the other fun stuff, but empty 40mm cases are easily found for \$.50 to \$1 each. Numerous commercial manufacturers have even come on the scene, turning out new supplies for us to purchase.

Sport shooting 40mm weapons is a happy combination of mortar, cannon, and high explosives. It takes a bit of skill to get on to them, but with practice, 40mm rounds are as accurate as light mortars within their firing

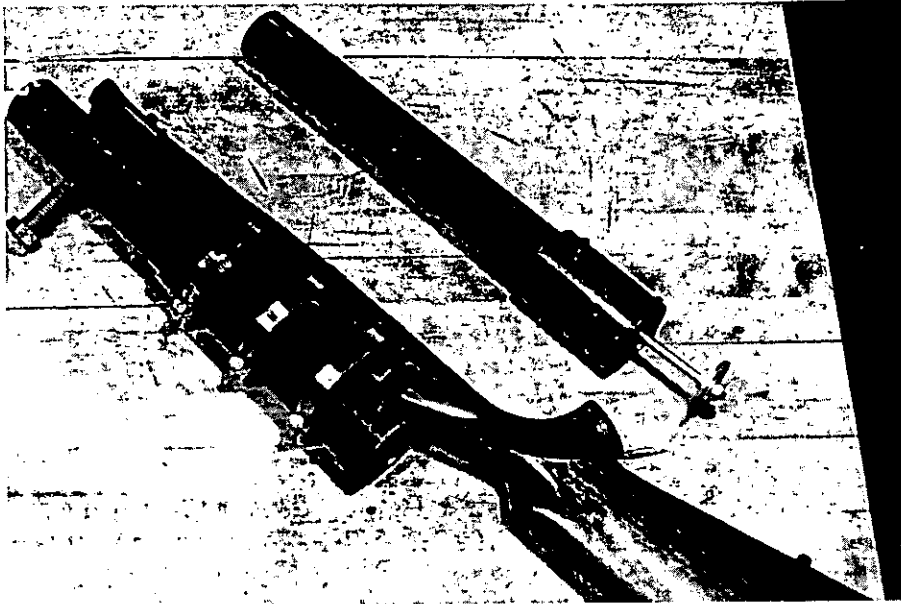

Two models of home-built 40mm weapons: M79 (left) and M203 (right) ready to be attached to a rifle.

distance. Grunts who practiced daily in Vietnam learned that they could put nine out of ten HE rounds through a hooch door.

the home builder of the most entertaining and interesting big-bore military systems of all: the 40mm M79 and M203.

A large number of loadings are available for the M79. One can use smoke, tear gas, shotgun, white phosphorus, and, of course, the intensely desirable HE rounds. Commercial manufacturers are even stepping up to the plate, offering new shot, smoke, and even white phosphorus rounds.

All of this adds up to interesting times for military big-bore enthusiasts. Although it is not the early 1960s again, makers are faced with the relatively easy task of constructing a firing device out of common materials, and ammo is common and relatively easy to reload. The information that follows provides in-depth analysis and guidelines for

CHAPTER 11

HOME CONSTRUCTION OF AN M79

Construction of a good, effective, reliable M79 in one's basement workshop is so simple that most people will require only this chapter's photographs to complete the job. Gun nuts no longer need furtively fantasize about fun-filled afternoons pooping out heavy grenades. My estimate is that hundreds if not thousands of fun-loving readers will construct their own M79, and not a single person will spend more than \$50 for parts, nor invest more than a week's work (forty hours) assembling them.

There are three major components for which the builder must scrounge a bit. For some of these acquisitions, circumstances and luck play a minor role. All can be purchased if need be. The first, falling squarely in the category of "it's nice if you can scrounge this piece from your old parts bin," is a surplus rifle stock. The stock can be military, commercial, or even surplus in origin. Almost any pre-cut rifle stock will work. Buy one if you must, but it is always nice to use that old stock you have had lying around for years. Forty millimeters

Parts List for M79

- 16-inch length of 1 1/2-inch (inside diameter) standard-weight steel pipe
- 9-inch length of 2-inch (inside diameter) heavy-walled steel pipe
- 1 1/2-inch length of 1 1/2-inch steel pipe
- 2-inch long 3/4-inch bolt
- Three heavy-duty hose clamps (approximately 4-inch)
- Twelve 1/4 x 28 Allen screws 3/4-inch long
- One 3/4-inch heavy flat washer having approximately 2-inch diameter
- Three 5/16-inch machine-thread nuts
- One 5/16-inch machine-thread bolt 3 inches long
- One surplus rifle stock

are hard on stocks, so choose a stout military variety if possible.

After this the assembler will require a breech sleeve and barrel. The breechblock is made from some of the same material used in the barrel. Construction of the breechblock and firing pin, comprising the third component group, definitely constitutes the only part of this project requiring mechanical ability past the level of the average cocker spaniel.

Starting from the top, go to the nearest full-service steel warehouse, welding shop, machine shop, or well driller's supply house. You will need to purchase two pieces of steel pipe. The best, strongest pipe commonly available is DOM, which translates roughly into "drawn over mandrel" pipe. DOM pipe has no seam and is generally considered to be tougher material than standard pipe, better able to withstand higher internal pressures. In some places in the United States, DOM pipe is not available; if that's the case in your area, use the best high-grade steel pipe available. In my area,

machine shops don't carry DOM pipe. The steel pipe they do carry will reportedly withstand 10,000-psi pressures which, even without the heavy breech piece, is absolutely adequate for the intended purpose. Steel pipe required for this project is not of the type one is likely to find in plumbing shops.

For the breech, purchase one 9-inch-long piece of 2-inch diameter heavy-walled steel pipe. Standard-walled 2-inch will not, in this case, work. Be sure to specify heavy-walled 2-inch pipe. Have the shop cut the pipe stock and then clean the newly cut ends with their reamer. By so doing they will smooth off the sharp edge and burrs in a much neater fashion than one can ever hope to accomplish at home. The extra dollar or so spent on this operation is money extremely well spent.

M79 barrels can be any length the builder desires. Accuracy and range are not sacrificed by short barrels. Issue M79s have 14-inch barrels. Many gun nuts feel that length is a bit short for the style of weapon they are building, opting instead for a barrel about 16 inches long.

Select a piece of standard-weight steel pipe with a 1 1/2-inch inside diameter. Check to see that it is the correct diameter by pushing an empty 40mm case into the pipe. The empty should fit suffi-

ciently snug so that one must push fairly resolutely to get the case inserted all the way. Later you will polish out the bore of the weapon with fine emery cloth so that the rounds drop in easily. At this time all that is needed is an indication that the correct pipe is indeed in hand. When you decap the nylon case first, the machine shop attendant will almost certainly be unaware of the origin of your gauge, as 40mm cartridges do not really look like cartridges.

Test the two pipes by ensuring that the barrel piece (16 inches long, 1 1/2 inches in diameter) will slide closely inside the breech piece (9 inches long, 2-inch inside diameter). First-time M79 builders can be certain they are on the correct track for size and wall thickness by purchasing both the barrel and breech pipe at the same time. The only disadvantage to purchasing both items at the same shop is the fact that the clerk may ask questions you may not wish to answer.

While at the machine shop, have a piece of 1 1/2-inch stock cut 1 1/2 inches long. This piece will become part of the breech later on in the construction process. The short piece can only be reamed on one side since it is too short to lock into the power-cutting tool. This will not be a problem in the final assembly.

On the way

Use any sturdy surplus stock you have on hand or can purchase reasonably (left). Polish out one end of the 1 1/2" pipe with fine emery cloth until the 40mm cases slip in and out easily (middle). Thin-walled 1 1/2" steel pipe should slip inside heavy-walled 2" steel pipe breech (right).

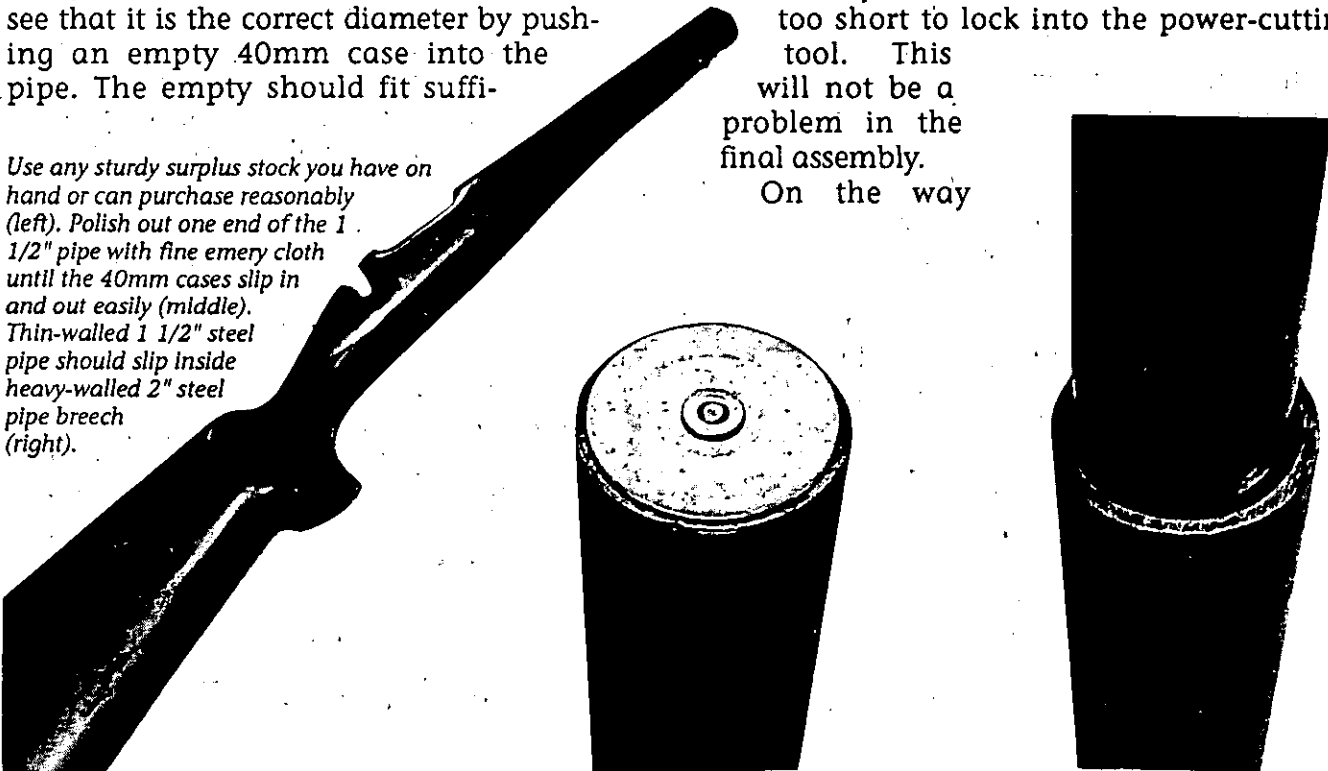

Building and Keeping Your Arsenal Secure

home from the machine shop, stop at the largest full-service hardware store in the area. Purchase one 3/4-inch bolt 2 inches long, three heavy-duty 4-inch hose clamps, a dozen 1/4 x 28 Allen screws 3/4-inch long, a 3/4-inch flat washer with a 2-inch overall diameter, three 5/16-inch machine-thread nuts, and one 3-inch-long bolt of the same thread.

Larger flat washers come with various-sized inside holes. The trick here is to find a heavy washer with a 2-inch outside diameter and as small an internal hole as possible. One hopes your hardware store will have one that will work. If not, try a farm and implement store. Tell the clerk what you need; he will almost certainly scrounge one up for you. Try to come up with a washer with an approximate 3/4-inch center opening.

A dozen Allen screws is probably too many for the task at hand, but they tend to break and get lost on the floor. Buying a dozen prevents emergency trips to the hardware store in the middle of the night.

The 4-inch hose clamps are used to secure the breech piece to the rifle stock. Depending on the stock finally scrounged, it may be necessary to use clamps from as small as 3 inches up to 5 inches. A surplus 03 Springfield, Enfield, or Mauser stock will all work with 4-inch hose clamps. Larger Enfields will require larger clamps. Stocks a bit long can be trimmed back easily to suit the builder's fancy.

A 2"-long 3/4" bolt welded to barrel 3 1/2" from muzzle. The weld must be very secure.

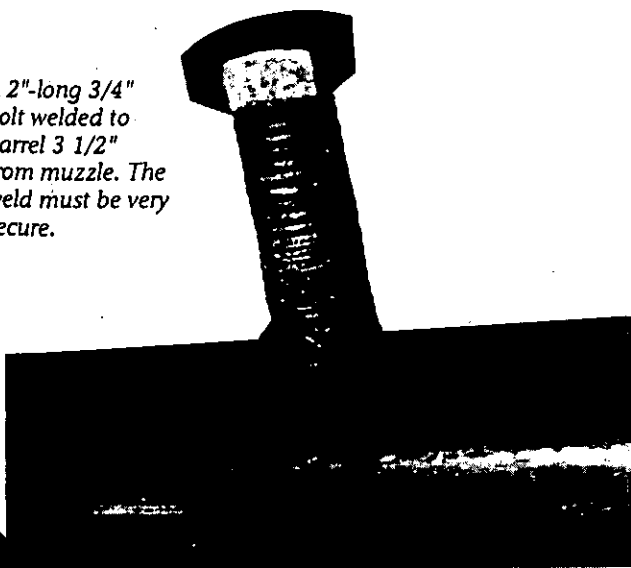

Polish down 3/4" washer on the bench grinder until it slides into the 2" breech piece.

Back in your shop, select the cleanest, most open end of the 1 1/2-inch barrel pipe for the chamber and polish it out. Securely weld the 3/4-inch bolt to the other end of the barrel 3 1/2 inches from the muzzle. Take particular caution to stand the bolt out perpendicular to the barrel, and to weld it securely all the way 'round. (A friend inadvertently welded the bolt to the breech end, necessitating another two hours of polishing the chamber.)

Customarily, 2-inch washers are very thick. Should the ones found in your area be under 1/4 inch in thickness, however, it will be necessary to weld two together to provide the necessary heft. Factory-new 2-inch washers will not slip into the weapon's 2-inch breech piece easily. Using a common bench grinder with medium stone, grind down the washer round and round till it slips down into the breech easily and evenly. This work can be accomplished by holding the washer with thick leather gloves, allowing it to rotate as it is dressed down by the grinding wheel. Test it in the breech often as the work proceeds so that as smooth a fit as possible is maintained.

On completion of the washer fitting, lay it on a heavy iron anvil or large vise. Place a 5/16-inch machine-thread nut in the center hole, being sure it is flat on the down side. Very carefully braze the nut into the center of the washer. Be especially careful to protect the

A 3/4" steel washer with 5/16" nut brazed in center. Finished firing pin and lock nuts also shown (above). Side view of the breech washer welded to 1 1/2" pipe piece. Note two craters that act as seats for Allen screws (right). Close-up of locking Allen screw, one of three used on breech tube of the M79 (below).

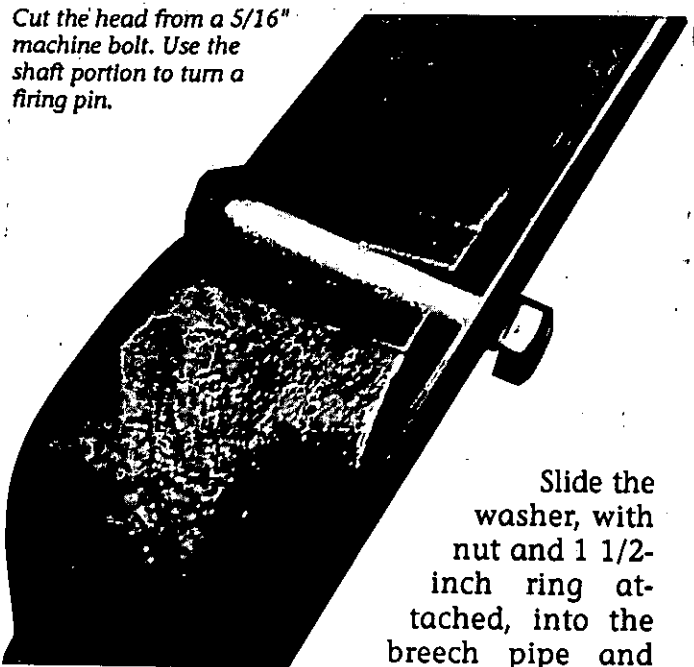
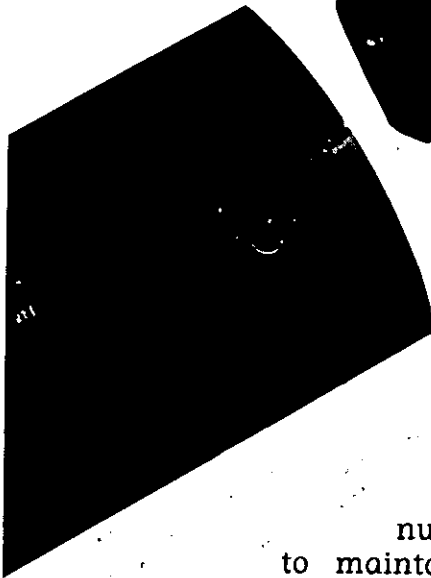
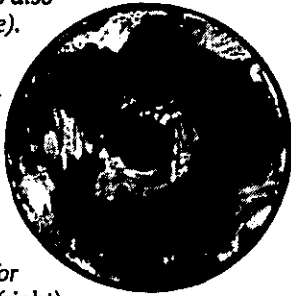

Cut the head from a 5/16" machine bolt. Use the shaft portion to turn a firing pin.

Slide the washer, with nut and 1 1/2-inch ring attached, into the breech pipe and tighten down the

three Allen screws to mark the breechblock ring inside. Withdraw the ring and drill shallow craters at the places it is marked. Replace the ring again, this time tightening the Allen screws and securing it solidly into the main breech piece. Torque down the Allen screws as securely as possible. Some might break during this procedure, but they can be replaced easily.

Any machining required during the course of this project is included in the next step: making an adjustable firing pin.

Thread the 5/16-inch bolt down to its head, assuming it was not possible to purchase a prethreaded bolt of the correct size. Using a hacksaw, cut the head from the bolt and carefully grind the cut end flat.

Now, carefully wrap tape around the end of the bolt to protect the threads. Chuck the bolt, tape end first, into a 1/2-inch drill. This drill is about to become your lathe to turn the bolt into a firing pin. Clamp the drill into a vise or tie it securely to a tabletop.

Turn the drill on, rotating the bolt shaft. Using a 4-inch fine flat file, work the bolt down to a fine pin diameter of about 1/16 inch. Cut the pin back only 3/8 inch from the end of the bolt. When the pin is the correct diameter, put a sharply beveled point on it.

nut's threads and to maintain its center alignment. This nut will eventually retain the firing pin, providing you an important opportunity to adjust the pin in and out.

Lay the small 1 1/2-inch-long ring of 1 1/2-inch pipe on the washer carefully and braze the two together evenly. The center hole of the washer must lay exactly in the center of the ring. Braze them all into one solid mass, again paying close attention to preserving the nut's threads in the center of the washer.

Using a 13/64 drill, drill three opposing holes through the breech piece 3/4 inch from the rear of the piece. Tap them with your 1/4 x 28 tap. Try the new holes with the Allen screws, but do not set the screws permanently in place.

Building and Keeping Your Arsenal Secure

Take the pin out of the drill, remove the tape, and cut a shallow screwdriver slot with a hacksaw on the opposite end. This entire operation may take thirty minutes or more, assuming it is done correctly the first time, but on completion the firing pin is ready to be screwed into the breechblock piece. Set it in the block so that it barely protrudes through the washer and nut. Set it too long and it will tend to bend or break. Set it short and it will fail to detonate the round.

Some trial and error is required at this point. Punch the propellant cartridges out of several 40mm empties, then recap and reset them in the 40mm cases. (Complete data on cartridge loading is included in Chapter 5.) Use these primed cases to test the action of your new M79.

If you have not already done so, secure the

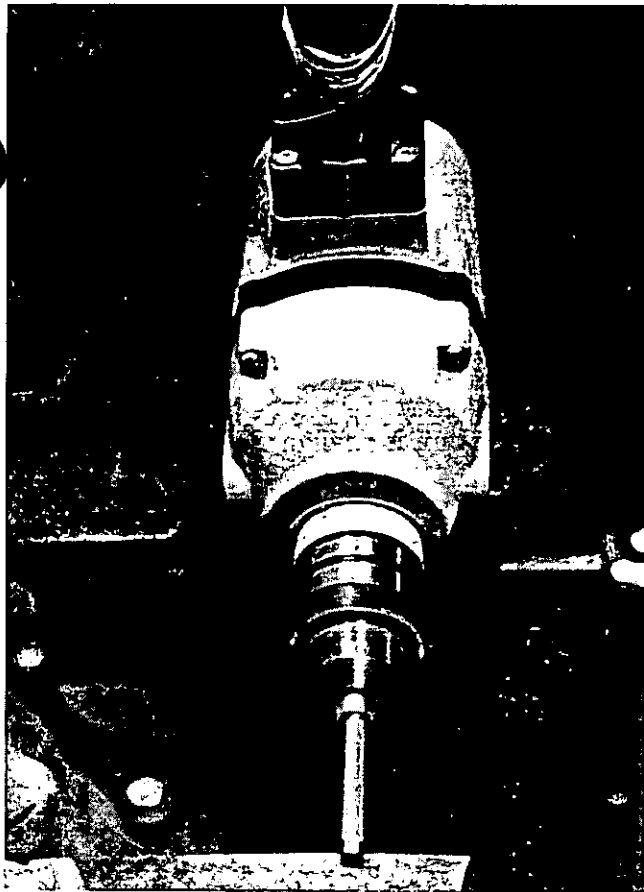

Wrap tape around bolt threads and chuck into fastened-down 1/2" drill. Work the end down to 1/16" for the firing pin.



Face of firing pin assembly with firing pin protruding through washer.

breech piece, now with firing pin installed, to the rifle stock using three hose clamps.

Although the recoil from the weapon is more of a gentle nudge than a sharp kick, there is still enough there to back the round, smooth breech piece through two clamps. Three are recommended.

Since this is a fairly powerful and potent firearm, I recommend test firing at least two military rounds through the newly made weapon from a tied-down position. Use military ammo rather than reloads, pro-

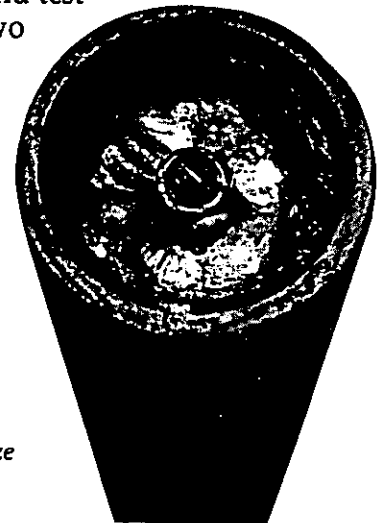

Completed firing pin assembly installed in breech pipe. Note screwdriver slot and secure braze holding assembly to pipe.



Clamp the completed breech to the rifle stock. Test the firing pin using primed cases; test completed M79 with military surplus rounds.

Completed home-built M79 ready for action.

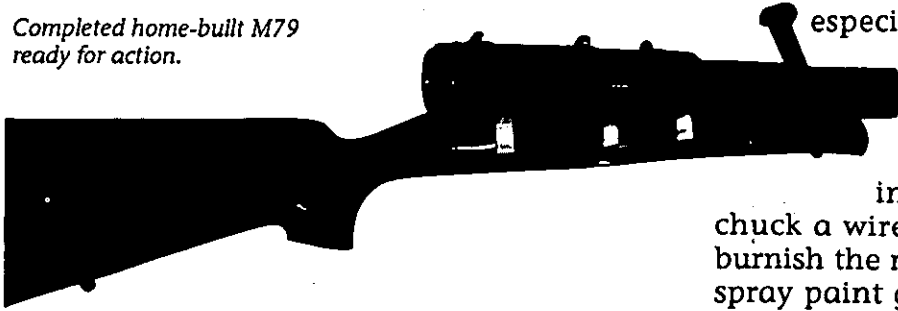

viding only one set of variables under one test at one time.

Lay a piece of clean white cloth over the breech and then a piece of heavy canvas over that. Load up the barrel. Using the 3/4-inch bolt as a handle, slam the loaded barrel lock into the breech to discharge the weapon. By this time, the maker should be familiar with the firing action as a result of the trial-and-error setting of the firing pin when using primed cases.

The weapon generates little noise on discharge. In that regard the newly built M79 can be test-fired in fairly populated areas. However, the range is greater than one might normally expect. Caution is advised lest you too drop a smoke round on the neighbor's porch.

Assuming one has taken the time to adjust the firing pin correctly and has torqued in the breech piece securely, there should be no problems. This is a low-pressure weapon,

especially suited to home manufacture. The weapon is ideal in that it is so high-tech it has become low-tech.

At the conclusion of the testing, some owners may wish to chuck a wire brush into their grinders and burnish the metal parts. A thin coat of black spray paint gives the finished M79 an especially ferocious appearance.

It does not appear necessary to install either a safety or sights on home-built M79s. Sights are fairly complex to build or expensive to buy if one uses surplus parts, and they are not particularly effective anyway. Most people learn to do quite nicely using only estimation and Kentucky windage. Because it is easily possible to see the round in flight, it takes but ten or fifteen practice tries to become surprisingly proficient.

A good, sharp tug on the barrel is required to fire the cartridge, so a mechanical safety is mostly superfluous. If a safety seems absolutely necessary, drill a 1/16-inch hole in the breech just ahead of the breechblock. Insert a piece of piano wire (purchased from a hobby shop) in the hole so that it lies between the round and the firing pin. When ready to fire, just pull the wire.

Remember, this is a big, powerful weapon. Do things carefully and properly. Even then, it is extremely easy to injure oneself in the process. Let the builder beware.

CHAPTER 12

HOME CONSTRUCTION OF AN M203

Constructing a good, workable M203 in your home workshop is not as simple as building an M79, but it is still possible for those who are only marginally mechanically inclined. The project will, like the M79, cost less than \$50 for supplies, but the wise builder will budget a minimum of sixty hours of construction time.

Building a workable breech mechanism containing a functional firing pin requires quite a bit of welding. Some of this welding must be done with a fair degree of precision. In the end, the trigger is more Mickey Mouse than clever high-tech, but it has the distinction of being workable.

After my having issued those appropriate disclaimers, do not be dismayed or discouraged. A good, workable M203 can be yours if you persevere and are willing to possibly do several of the steps over again without becoming unduly discouraged.

First thing, head straight to your nearest, most user-friendly steel supplier or machine shop. Purchase one piece of heavy-walled 2-inch (inside diameter) DOM steel pipe or

Parts List for M203

- 4-inch length of 2-inch (inside diameter) heavy-walled steel pipe
- 12-inch length of 1 1/2-inch steel pipe
- 5/8-inch length of 1 1/2-inch steel pipe
- Four 3/4-inch heavy steel flat washers
- Seven 1/4-inch steel flat washers
- Round piece of tin, exact size of 40mm case
- One 5/16-inch machine bolt, 6 inches long
- Two 5/16-inch machine nuts
- One 5/8 x 4-inch compression spring
- One 3/8 x 3-inch compression spring
- Piano wire
- One 1 x 1 1/2 x 4-inch wood mounting block
- Three heavy-duty 4-inch steel hose clamps

other high-grade seamless steel pipe stock for your breech. Have the shop cut it 4 inches in length. While there, also have the machine shop ream out the freshly cut ends, producing a nice, clean rim free of sharp lips or nicks.

The barrel piece is cut from 1 1/2-inch standard-weight DOM stock or other high-grade, seamless steel tubing of the same general type as the breech piece. Slide an empty 40mm cartridge into the tubing to be sure the diameter is correct. Slide the barrel piece through the breech piece

as well, being certain that the fit is close.

Barrel length for an M203 is a matter of personal preference, with everything from 9 to 16 inches being workable. Lesser lengths are lighter and as accurate as longer, arguing for a 10- or 12-inch model. As with the breech piece, ask the machine shop to thoroughly ream out the ends, removing burrs and overhang left over from the cutting process.

At this time, also have the shop cut a 5/8-inch piece of 1 1/2-inch stock to be used later as a breechblock retainer. Because of the short

length, only one side of the piece can be reamed. This should constitute no problem during final assembly.

In your shop at home, use a piece of fine emery cloth to polish out one end of the barrel so that the 40mm rounds drop easily into the chamber.

Measure in one inch from the polished chamber end of the barrel and punch a mark on the outside. Exactly 180 degrees around the other side, mark and punch again. Using the solid shaft portion (not the threaded end) of a 1/4-inch machine bolt as stock, weld two 3/4-inch studs securely onto the barrel at the locations marked. This operation must be done with an arc welder, and it must be accomplished so that the two studs stand out absolutely straight and are as solid as electric welding can make them. These studs must also be on exact opposite sides of the barrel.

Using a large flat file, trim off the excess weld from around the studs. These studs will eventually secure the barrel to the breech by sliding into slots cut in the breech piece. Look ahead in this chapter to determine which surfaces should be smoothed down with the file. Obviously, if all are taken completely off, the studs will retain little strength.

Slide the barrel piece, stud end first, into the breech piece until movement is stopped by the two studs. Mark the spot on the breech piece rim where the two studs hit. Using either a hacksaw, file, or saber saw equipped with metal blade, cut two slots down into the breech piece. Keep the slots as narrow and straight as possible while still allowing space for the studs to pass through.

When the in-and-out slot is from 3/4- to 1-inch deep, cut two slots at right angles paralleling the end of the breech piece. These L slots allow the user to turn the breech piece around the barrel studs, locking the two pieces together. Cut both right-angle slots simultaneously at least 3/4-inch long, testing the fit often. The job is completed successfully when the breech piece will turn and lock.

Polish out the chamber of the M203 and weld two studs 1" from the breech end. These welds must be very solid and not sloppy (right).

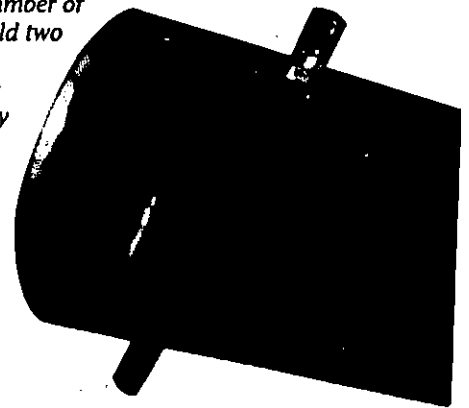

Completed M203 barrel with locking studs welded in place (left).

Completed breech piece showing L slot and two Allen screws that hold firing pin mechanism (below).

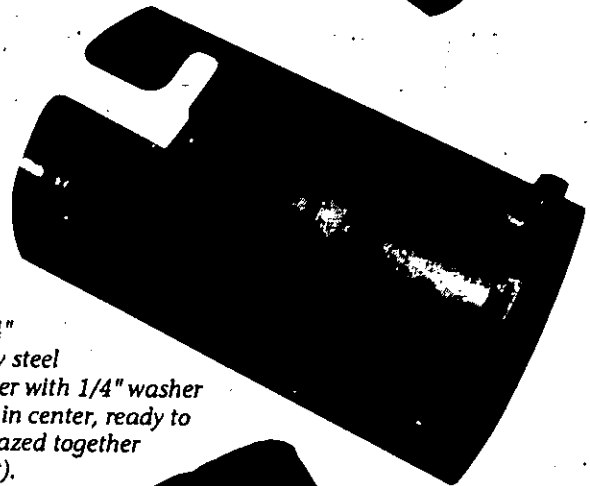
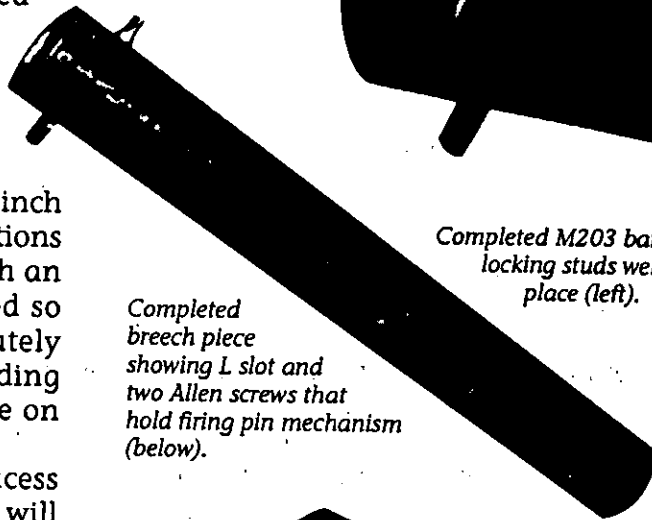

A 3/4" heavy steel washer with 1/4" washer lying in center, ready to be brazed together (right).

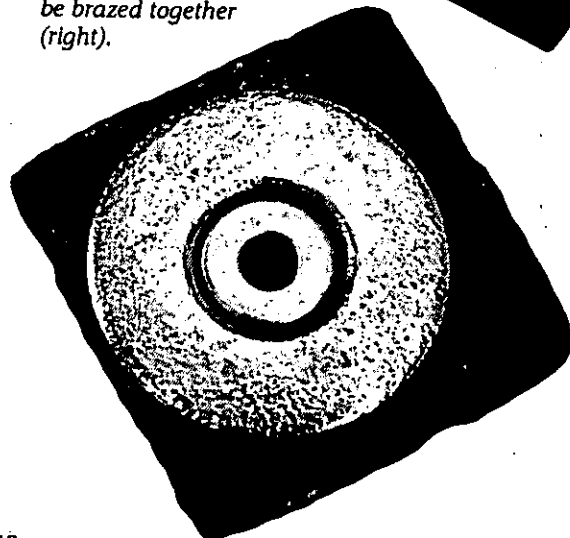

It is helpful to use a small rattail file or chain-saw file to cut two small circular chambers at the end of the L slots so the studs can slip into these positions and hold the assembly together.

The easy portion of assembling an M203 is now behind the builder. What comes next is often frustrating and difficult for the mechanically disinclined.

Purchase four heavy-bodied 3/4-inch (hole) washers having approximately a 2-inch diameter. These are always available in farm supply stores and usually available from full-service hardware stores. Polish down all four washers very slightly so that they will just slide into the 2-inch breech piece. This is best done by rotating them gently on a rapidly turning stone of a bench grinder. Wear heavy leather gloves or else other more expensive parts besides the washer may be ground down.

Heavy 3/4-inch washers of an approximate diameter of 2 inches will just about contain a regular 1/4-inch flat washer in the center hole. The fit is actually a bit sloppy, and the 1/4-inch flat washer is much thinner than the 3/4-incher, so eventually two will be used.

Carefully place the 1/4-inch washer flat inside the turned down 3/4-inch washer, laying both on an anvil, steel vise, or other flat massive steel surface. Center the hole in the 1/4-inch washer exactly inside the larger, cut-down 2-incher. Being ever so exacting, using a small flame to keep movement down, braze the smaller washer to the larger. After that washer is secure, place a second in the hole exactly over the first and braze it fast. These two washers together provide sufficient heft to match the outside washer when brazed solid all around.

Brazing tends to warp the pieces out of alignment a bit. Take great care that the hole in the finished product is centered and that the brazed package is absolutely flush flat on one side. If it is not flush and flat, it may be possible to grind or file the lumps out. If the hole is not centered, throw the washer away and start over.

Place an empty, unprimed 40mm round in the barrel piece. Lock the barrel onto the

breech piece via the L slots previously completed. Drop the washer in on the barrel through the back of the breech piece. It should be possible to see the exact center of the 40mm case through the 1/4-inch hole in the washer. Take this washer back out for now.

Cut an old piece of tin can, tin sheet, or copper to the exact circular dimension of the 40mm round. Drop the circular metal piece down onto the empty 40mm case and place the washer back inside the breech tube over the top of the tin circle. Be sure the package is packed together tightly and that both tin and washer bear down flat against the 40mm case. Punching a neat, clear hole in the center of the tin spacer helps immensely to keep all the centers lined up.

Using either a gas or electric welder, weld the washer in place inside the breech tube. Weld it completely around, as opposed to tacking in three or four places. Theoretically, the tin piece will prevent the weld from heating up the empty case while it does its job of providing the correct space in the breech.

After welding, the tin piece is discarded. Weld only the rear of the breech washer. Even a very smooth, professional weld on the front (cartridge) side of the washer will destroy the headspacing of the barrel (if one can use this term under these circumstances).

By grinding and brazing, prepare a second 2-inch washer like the one already welded fast inside the breech piece. Drop it in on top of the first washer. The two 1/4-inch holes should align perfectly with each other and the primer in the cartridge below. A metal rim left from welding the first breech washer in place should hold the second, most rearward washer off the face of the first about 1/4 to 3/8 of an inch, providing free travel space for the firing pin. A sloppy job of welding in the first breech washer will quickly put the kibosh on the project at this point.

Doing everything by eyeball measure provides numerous opportunities for inaccuracies, especially for those with no aptitude as machinists. Fortunately, the steel breech piece

and washers used so far are very inexpensive. Little except time is lost by going back and starting over.

Assuming all looks proper, slide the small $5/8 \times 1\ 1/2$ -inch piece of steel pipe into the breech. This is used to keep the second backing washer in place. Drill a single $13/64$ -inch hole into the breech piece and tap it with a $1/4 \times 28$ tap. Secure the steel ring in the breech with an Allen screw set in as tightly as possible.

Construction and final assembly of the firing pin constitute the last major hurdle facing the M203 builder. Start the pin construction process by cutting the head from a 6-inch-long $5/16$ -inch machine bolt. Save the threads on the opposite end for later.

Wrap a piece of heavy tape around the threads and chuck the steel shaft, threaded end first, into a $1/2$ -inch drill. Using a 4-inch file, cut a fine tip on the bolt approximately $1/16$ inch in diameter and $3/8$ inch long. Three-eighths is too long for the firing pin tip but is about as short as one can cut it using semiprimitive home workshop tools. At the end of the process, slope the shaft leading up to the firing pin so that it will slip through the washer assembly easily. Trim the firing pin tip back till it's about $1/4$ inch long. If you did not shorten the tip, the firing pin will bend and break after only a very few rounds.

Drop the turned-down firing pin through the two breech washers, allowing it to protrude out the cartridge side of the breechblock assembly about $1/4$ inch, including the shortened pin itself. Mark the pin shaft at the spot immediately above the second rearmost washer set inside the breech tube. This is a very critical and sensitive measurement—one that, if done incorrectly, may lead to the turning down of a second firing pin.

Drill a $1/16$ -inch hole through the firing pin at the mark. This hole marks the farthest point forward that the firing pin can travel. Push a cotter pin through the hole and place a $5/16$ -inch washer on the steel shaft behind the cotter key. Place a $5/8 \times 4$ -inch compression spring down on the washer. Quite a bit of force must be exerted on the firing pin by this



A $1/4$ " steel washer brazed inside a $3/4$ " steel washer, forming a solid unit. One side must be perfectly flat, as this completed washer shows.

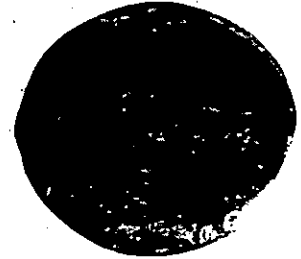

Tin spacer that will temporarily be placed over an empty round in the M203 barrel.



Place completed washer in breech piece (locked to barrel), with tin spacer separating washer and a round in the chamber. Weld washer fast to breech piece, maintaining headspace established by the empty round and tin spacer.

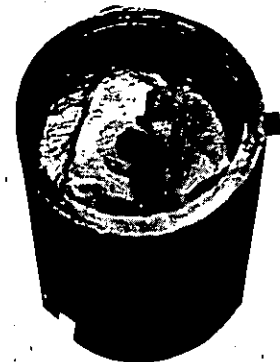

The $1\ 1/2$ " steel pipe piece dropped in breech as spacer, with firing pin washer dropped in on top of welded washer-spacer and second washer.

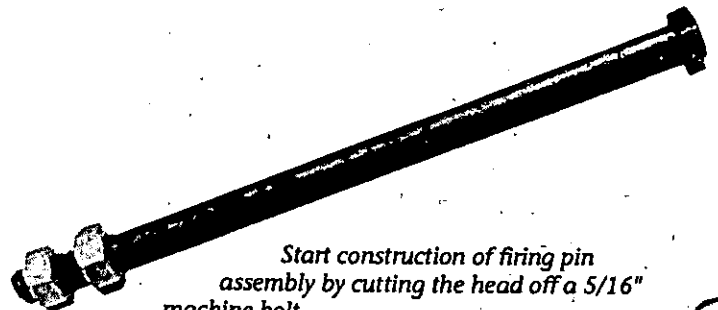

Start construction of firing pin assembly by cutting the head off a $5/16$ " machine bolt.

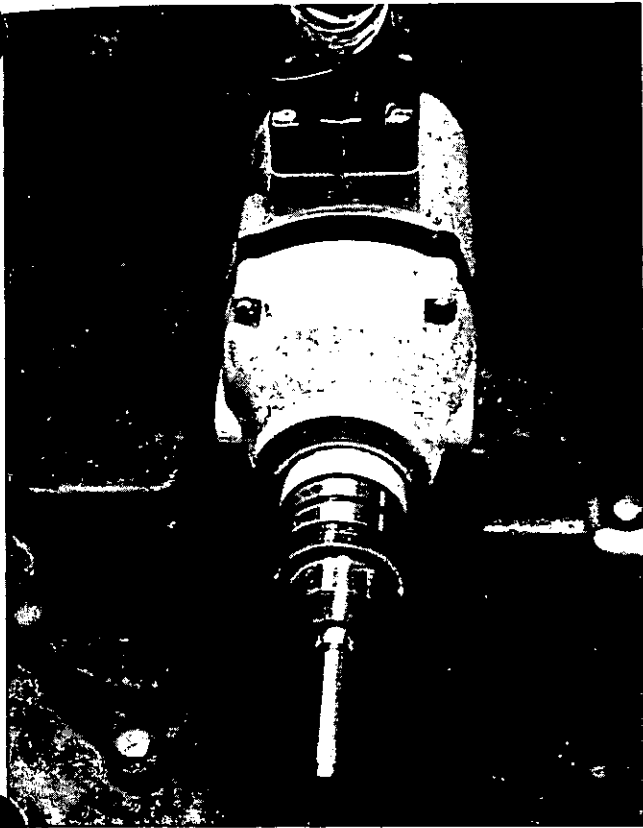

Chuck the bolt in a 1/2" drill. Work the tip down to a 1/16" x 3/8" firing pin. Shorten the pin to 1/4" so that it will not bend or break.

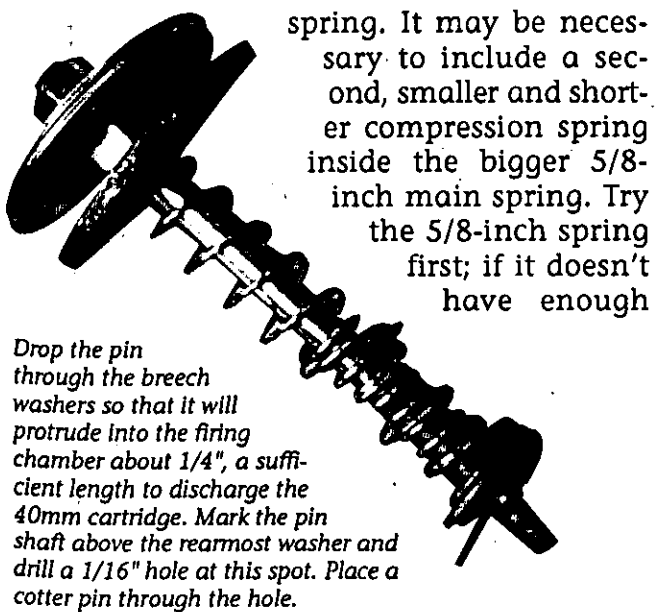

spring. It may be necessary to include a second, smaller and shorter compression spring inside the bigger 5/8-inch main spring. Try the 5/8-inch spring first; if it doesn't have enough

Drop the pin through the breech washers so that it will protrude into the firing chamber about 1/4", a sufficient length to discharge the 40mm cartridge. Mark the pin shaft above the rearmost washer and drill a 1/16" hole at this spot. Place a cotter pin through the hole.

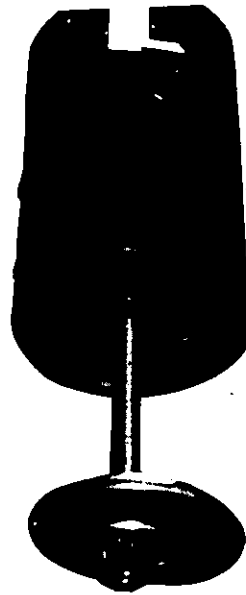

Lock rear retainer washer into breechblock assembly.



Add several heavy washers and nuts to firing pin to give it weight.

snap, use a second 3/8 x 3-inch spring that rides on the shaft under the main spring.

Construct one last trimmed-down 2-inch washer with two 1/4-inch flat washers brazed in its center. This washer becomes the rear spring retainer on the breechblock firing mechanism. Drill and tap two or three holes for 1/4-inch Allen screws at the rear lip of the breech piece. Cinch these Allen screws down onto the washer thoroughly, locking the spring and firing pin to the rear of the breech mechanism.

Thread a nut on the firing pin threads, which are hopefully still intact. Place two heavy washers on the pin and lock them in place with a second nut and flat washer. These washers give the user a place to grab while providing enough shaft weight to pop a 40mm primer. Try the mechanism on empty, primed 40mm cases. It is sometimes difficult to find springs with sufficient force that, when attached to the firing pin shaft, they will con-

sistently set off the primer. Adding mass to the shaft facilitates the process.

The best trigger is a simple wire-pull affair. Drill a small 1/16-inch hole in the firing pin shaft at the spot where the pin is pulled back to its maximum length. Insert a length of piano wire in the hole with a loop bent on the other end. Pulling the wire releases the pin, firing the M203.

To mount the device on a rifle, cut a 4-inch piece of hardwood block approximately 1 x 1 1/2 x 4 inches long. Using a hand saw, cut a shallow groove to fit the M203 barrel and a narrower groove to fit the rifle barrel. Each rifle will have its own unique block designed to hold the breech piece away from the weapon so it can be reloaded. The block also keeps the 40mm barrel from tilting into the rifle barrel so that one does not shoot the end off the other.

Home-built M203s are a bit more cumbersome than military-issue versions, and the trigger mechanism is not really a trigger as we know it. The device does work, however, and can be extremely effective, lobbing large 1/2-pound grenades out as far as 200 to 300 hundred yards or more.

Pull firing pin as far back as possible, mark the spot, and drill a 1/16" hole for trigger wire. Insert trigger wire.

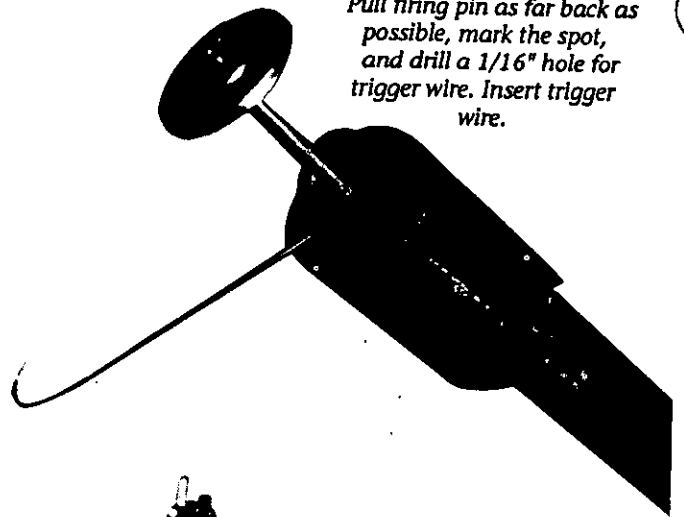

M203 firing pin removed from breech, showing hole for trigger wire.

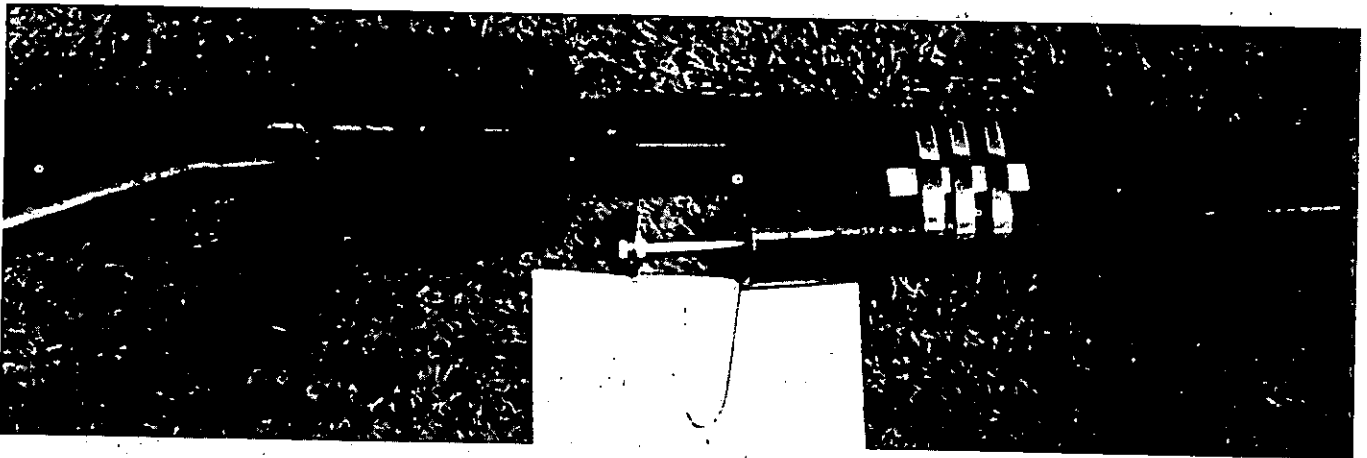
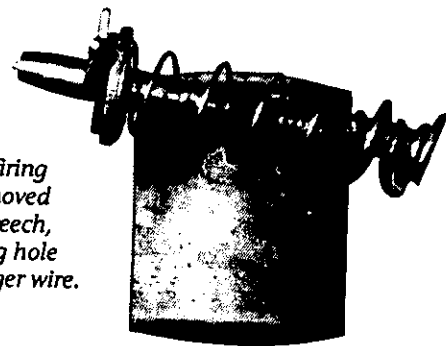

The M203 is fastened to a rifle using 1" block of wood with cut groove. Angle the barrel so that one does not shoot the other off. Use three hose clamps to ensure stability.

This home-built M203 must be tested first with empty, primed cases and then with military practice rounds. Be absolutely certain the

device is reliable before using it to launch homemade explosive rounds.

CHAPTER 13

INTRODUCTION

Paramilitary survivors and others who have seriously contemplated their circumstances realize they need a powerful weapon to deal with armored police and/or military vehicles, including tanks and armored personnel carriers (APCs). Survivors also know that they might need a means by which to hold off a large number of hostile people.

To prepare for these and other survival scenarios, some have acquired superaccurate sniper rifles, homemade mortars, automatic weapons, exotic explosives, or Molotov cocktails. Unfortunately, these weapons aren't effective against extensive firepower and/or military-type police hardware.

Most traditional defenses have severe limitations. Sniper rifles, no matter how well handled, are totally ineffective against buttoned-up armor. High explosives are dangerous, usually illegal, and require considerable skill to deploy because they are perishable and must be stored for an indeterminate period of time against the day of need.

Many of the most highly desirable devices are also highly illegal. Legality—or the lack thereof—may not be the determining factor for hard-core paramilitarists, but under some circumstances, it could be a consideration. Certainly some sort of destructive-device or weapons ordinance prohibiting possession of flamethrowers could be dredged up in places such as California or New York. In most places, however, one can safely assume that

the Bureau of Alcohol, Tobacco, and Firearms (BATF) boys will not be looking for flamethrowers.

Military-grade flamethrowers can be built and operated legally by virtually anyone willing to invest the time and sweat. Unlike explosives requiring special training, flamethrowers can be used by anyone who can operate a garden hose and will take a few weekends to practice. For those willing to scrounge and improvise, the cost can be held to an extremely modest amount. So there is no reason for any survivor who might one day face otherwise overwhelming situations not to have a flamethrower. In inner-city locations, the owner of a flamethrower would almost certainly dominate his surroundings. Any survival bunker or retreat would be impregnable when defended by a determined owner with a good flamethrower and a modest supply of easily acquired fuel.

Imagine a small army of police, armed to the teeth, pulling up in bulletproof cruisers. Confidently and arrogantly, they confront what they suppose is a hapless victim, trembling in his retreat. Crouching behind their vehicles, they deliver their ultimatum: surrender or be blasted to oblivion.

Using his homemade dragon, the survivor silently proceeds to slime his attackers, their cruisers, and the ground around them with unlit napalm. The defender doesn't ignite the napalm in order to limit his own exposure to

the extremely volatile chemical (it is hoped that none of the invaders were smoking as they were being sprayed). Outside, his opponents find that they are unable to wipe the slime from their clothing or skin.

As an added precaution—depending on the prevailing winds, the intensity of the threat, and the amount of fuel available—the survivor may lay down a napalm barrier between his position and the attackers. Jelled napalm, as delivered from the flamethrower, will remain in an extremely dangerous form for a period of days. In some cases, its volatility may remain a week or more. Rain will eventually wash the substance away, but certainly not immediately.

If they have a lick of sense, the opposition (despite their firepower and hardware) will recognize their extremely exposed position. They will likely deduce that the survivor could easily fire a flare into the napalm, instantaneously wiping out the whole war party. Switching on the burner and giving them another shot of ignited material would settle the issue rather resolutely, destroying the armed force and most of their equipment.

This use of the flamethrower is strictly defensive, useful from set (and often hidden) positions. The flamethrower can be quite noisy, causing survivors to worry that its location (and theirs) might be revealed, but the machine can be muffled and made to run almost silently. For people who want more portability out of their weapons for defensive and offensive use while on the move, flamethrowers can be scaled down easily and quickly to allow additional mobility. Models

described in this book, even the smaller portable models, have great range when used with heavily thickened fuel. The basic difference is that portable units will not deliver the large volume of conflagration that a larger semistationary model will. A good compromise would be to mount a medium-sized dragon on an all-terrain vehicle, providing firepower, mobility, and versatility.

With the element of surprise assured, one should not underestimate the effective deployment of this device from a well-chosen defensive position. The range of raw, unlit, thickened napalm, when thrown into a calm environment, will be 150 feet or more depending on one's position. If the wind is cooperating, the results could be quite dynamic. Theoretically, a defender could neutralize a hostile group at a distance of a couple of city blocks or more.

Once having coated the enemy and/or established a napalmed perimeter, one need do little more than sit back and wait for developments. It may even be appropriate to detonate the napalm from another position should the attackers persist in their hostile behavior. If the authorities were to bring up an armored vehicle, the defenders might elect to fry it without further delay before the attackers understand what they face.

Unless one expects to defend against planes, helicopters, and/or mortars, a flamethrower offers the ultimate in retreat protection against ground attack. As an added bonus, flamethrowers are legal, relatively easy to build, reasonably inexpensive, and use common, inexpensive fuels.

CHAPTER 14

HISTORY OF FLAMETHROWERS

Light rain misted over the sparse trees, bushes, and grass that remained after sixty days of heavy artillery bombardment. German troops commanded by the Duke of Württemberg were scheduled to charge out of their muddy cesspool trenches at first light and take the Chateau de Hooge from the British. Two unsuccessful attempts and the unseasonably wet weather—which had turned the ground along the Menin Road three miles east of Ypres in Belgian Flanders into thin, runny, gruel-like mud—had dampened the Germans' optimism. Conditions on that gray, drizzly morning of July 30, 1915, left even poets and historians groping for words to describe the horror. Men were being choked by poison gas or pounded to protoplasm at a collective rate of more than 11,000 per day. At one point, a British attack penetrated four miles along a nine-mile front, with only 18,000 killed or wounded, leading commentators to assert that the action was a good one, characterized by "acceptably light casualties."

Starting at 3:00 A.M. German artillery fire saturated British lines, commanded by the popular but stoically methodical British General, Sir Herbert Plumer. Rounds, including some newly developed flammable projectiles, fell at a steady rate of twenty or more per minute. As on their two previous attempts to capture the Hooge on July 21 and 24, the Germans also used copious numbers of gas pounds and large cylinders of compressed gas

released from their positions into the light westerly wind. Deadly fumes wafted toward the British lines. At one point they generated a cloud of death five miles long and more than forty feet deep. A year earlier, this action would have decided the battle immediately, but that morning the British donned their newly issued rubberized ponchos, hoods, and breathing masks. Although crude, these devices had enabled British defenders during the past week to gun down German infantrymen as they followed the gas cloud into no-man's land.

Though the British were equipped for poison gas, they saw something new that day for which they were unprepared. Between fifty and one hundred "flame projectors," as they were called at the time, had arrived at the German lines the week before. As is so often the case, German commanders anxious to capitalize on any tiny advantage rushed the untried weapons into the hands of untrained men who carried them to the front in an indecisive manner. Similarly, the British rushed into action with their tanks, the Americans with their squad automatic weapons, the French with their fighter planes.

The first flame projectors consisted of bulky brass cylinders capable of carrying about six gallons of fuel and a leather-gasketed pump that created twenty-five to thirty pounds of pressure per square inch (psi). The Germans lacked the ability to thicken the fuel, so range

was limited to about forty yards under ideal conditions. The fuel was a mixture of lamp oil and gasoline, with perhaps a small percentage of pitch (contrary to British speculation that the fuel was a coal-tar product). It was ignited by a crude oil-soaked cotton wick that functioned as the pilot light for the sprayer nozzle. As a result of the thin fuel and the relatively weak pump pressures, ranges were such that the user had to charge right up to the lip of the enemy's track before the device had the slightest effect. The burning wick exposed the user to the enemy, and shortly defenders knew what to guard against.

The flamethrowers had other flaws as well. Simple tanks were fastened to a crude rack that was in turn strapped to the user, creating weight and balance problems for the soldier. Severely limiting its usefulness was the fact that the user could expect about five shots before emptying the reservoirs. If the flaming wick didn't attract fatal fire, the hapless soldier found he had at best a minute or two of combat effectiveness before

M2A1-7 Portable flamethrower (U.S.).

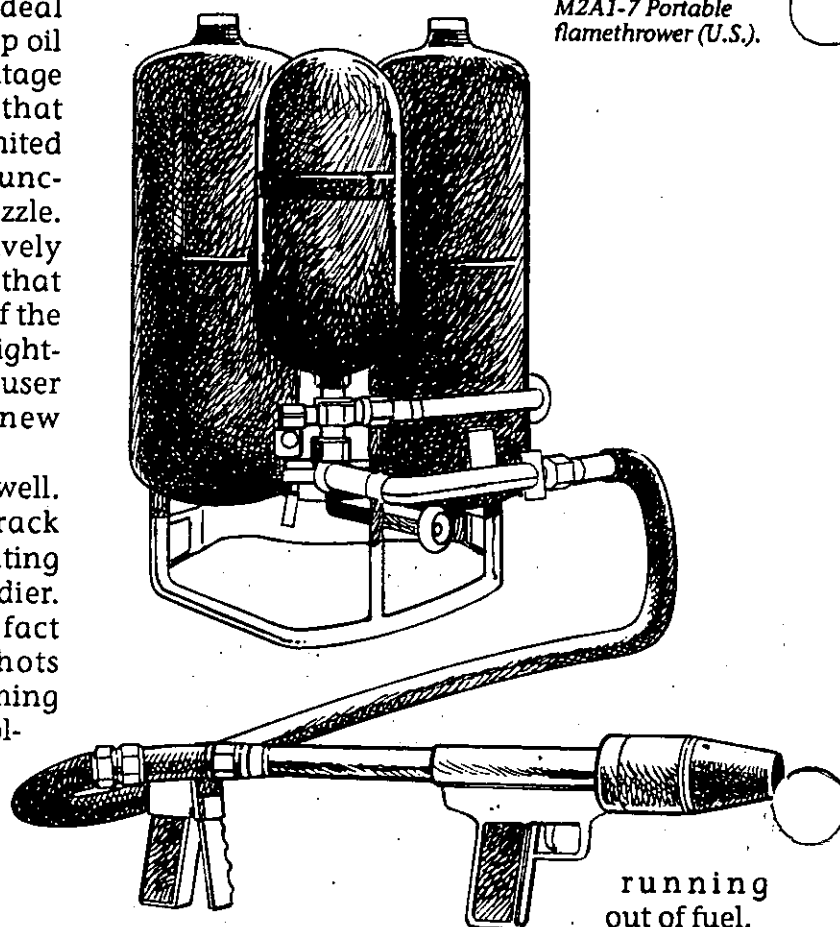

running out of fuel.

In that regard, flamethrowers were not particularly effective weapons, but their presence that day—along with napalm artillery rounds, which were mixed with high explosives and gas canisters and used for the first time in modern warfare—so surprised the British that they surrendered their forward positions (although the use of napalm was a major tactical leap, many of the details went unnoted or have been lost with time). Historical accounts noted that the British suffered about 2,000 killed, wounded, or captured that morning. The three-tiered organization by both armies precluded a victory by either side. An attacking force quickly overran its communications line before reaching the third system of trenches. Advancing troops sometimes were shelled by their own artillery;

M9E1-7 portable flamethrower (U.S.).

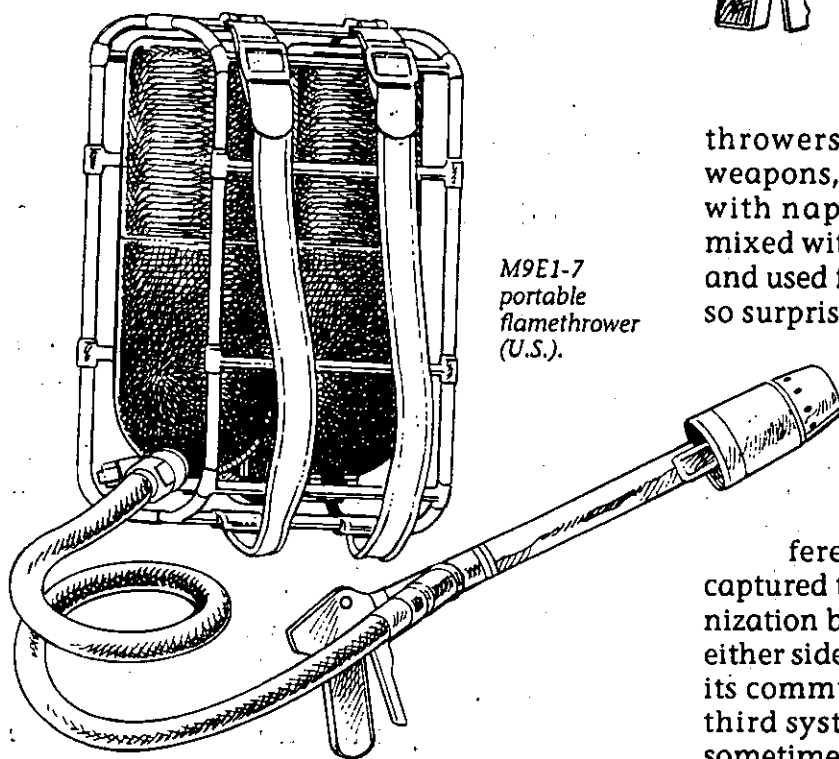

LPO-50
flamethrower
(U.S.S.R.).

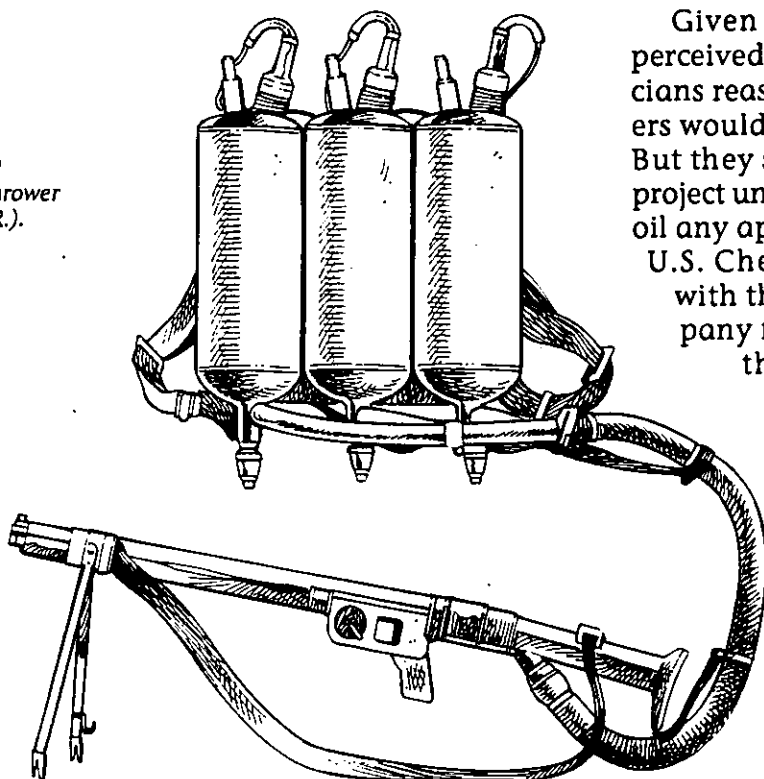

or, at best, they were forced to wait while the enemy repaired the breach.

Although the first use of flamethrowers was historically indecisive, the event was briefly noted by several writers. More than seventy-five years later, most historians know the event at the Hooze occurred but have no idea exactly when and under what conditions. The fact that flamethrowers are an offensive weapon, valuable only in a set-piece urban war, seems to have been overlooked by military commentators. Virtually no additional mention of flamethrowers can be found until well into World War II. Russian soldiers used them in Finland without averting the disaster that Finland was to become. Against the U.S.S.R. in Europe, the Germans designed more effective flamethrowers for urban use. They also used them to flush French, British, Czech, and Belgian troops out of their bunkers. British defenders installed vast networks of

flamethrowers along their channel coasts to thwart Nazi invasions.

Given the experiences in Europe and the perceived need in the South Pacific, U.S. tacticians reasoned that man-carried flamethrowers would be ideal to clear Japanese bunkers. But they soon realized it was not possible to project unthickened gasoline, motor oil, or coal oil any appreciable distance. Late in 1942, the U.S. Chemical Warfare Service contracted with the Standard Oil Development Company for materials that could be mixed in the field with common petroleum products to produce napalm.

Standard Oil was able to quickly produce a material that:

“... throws a cohesive rod of fire with such accuracy that it can be directed into a two-inch bunker slit sixty yards away. The jet, traveling at nearly two miles a minute, does not billow out but strikes its target as a solid, glowing stream, then splatters and sticks to any object, blazing with terrific heat that destroys guns and all life within a pillbox.”

The thickening agents developed by Standard Oil were simply mixtures of aluminum and soap, but they were treated as closely guarded military secrets. Military planners were not about to compromise what they thought was a significant military breakthrough with loose talk.

As a result, the Americans developed the model M1-A1 flamethrower. Some of these models are still seen in Third World arsenals around the world. The M1-A1 had two separate fuel cells containing about four gallons of napalm when fully charged. Use of two smaller fuel tanks rather than one big one gave the user a lower, lighter, more balanced profile. To these two tanks, developers mounted a third smaller tank containing massively compressed air to provide propulsion. In theory, the compressed air propellant lasted as long as the contents of the fuel tanks without diminished

performance. (At one time, it was thought that napalm had to be propelled with inert nitrogen gas, which further limited the use of flamethrowers. Most modern models are designed to use regular compressed air.)

Special electrically fired blank flash cartridges ignited the napalm. At best, the M1-A1 flame-thrower could produce seven one-second blasts. On Munda airfield in the South Pacific, U.S. Marines destroyed sixty-seven Japanese bunkers using flamethrowers. Most of these bunkers had already withstood protracted shelling, including direct hits from fighter bombers. By rolling in smoke grenades and deploying smoke pots upwind of the bunker, marine "hot foot" units, as they were called, could get close enough to splash napalm through the cracks in the bunkers, killing or routing the occupants.

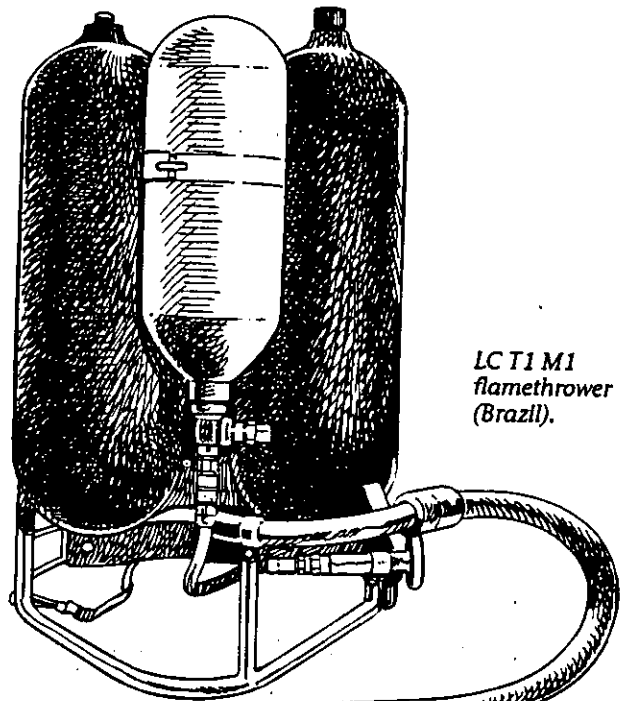

LCT1 M1
flamethrower
(Brazil).

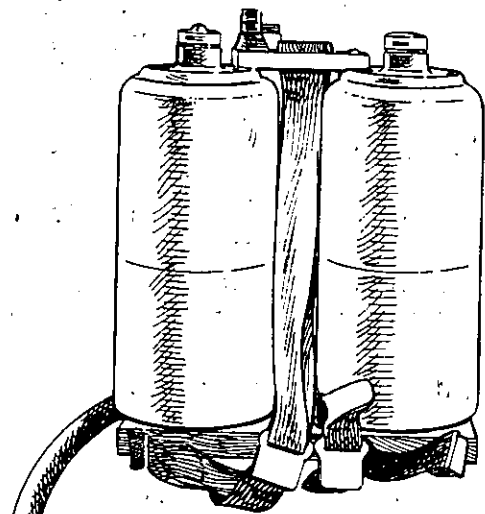

MOD T-148/A portable
flamethrower (Italy).

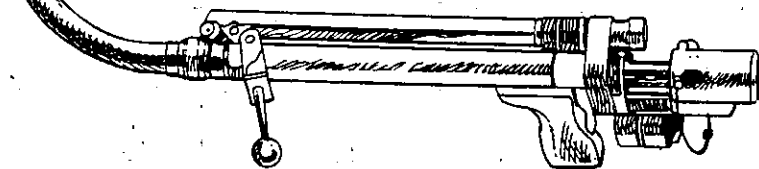

Meanwhile, on the European front, the British developed a forty-one-ton, armored, self-propelled flamethrower they dubbed the "crocodile." Reportedly, the crocodile had an accurate range of 450 feet. The Allies deployed a few in Europe against fixed positions, and U.S. forces made limited use of them in the South Pacific.

Somewhat improved U.S. flamethrowers saw action again in Korea and Vietnam. As a tool for burning villages and flushing out tunnels, they filled a valuable niche for U.S. servicemen. However, by the end of the

Vietnam War, the handwriting was on the wall. Small, easily portable white phosphorous and magnesium grenades were proving to be superior to the inconve-

nience of the flamethrower's clumsy tanks, racks, and hose.

Today, the U.S. military's inventory of flamethrowers is decreasing. Flamethrowers are an ideal urban weapon, but few military planners envision a war fought in cities and towns. Contingency plans call for bypassing cities or blowing them off the face of the Earth. At the battalion level, the armorer may have one or two among his stores, but the military relies primarily on modern explosives. Only rarely do soldiers receive training on the use of flamethrowers.

Obsolete U.S. military models that one may encounter around the world include the M2-A1-7 or the ABC-M9-7. Both are basically three-tank, four-gallon models, lit by electrically fired ignition cartridges. Both weigh about twenty-one kilos, or forty-six pounds. U.S. training manuals often showed users deploying their dragons from behind an obstacle, while the tanks were set to the side. (Undoubtedly, this is the position preferred by survivors.) The M9-E1-7 is the only model considered to be current in the U.S. armed forces today. Basically, this model is much like its predecessors. Filled, it weighs about forty-six pounds; maximum range with properly thickened fuel is forty-five to fifty meters. All models have three tanks, cartridge ignition, and a pack rack for soldiers. Useful life of the fuel in combat is from five to seven seconds.

Soviet flamethrowers employ a somewhat different mode of operation. The LPO-50 is the flamethrower currently in use among Warsaw Pact armies. The LPO-50 consists of a three-tank unit with manifold. Each tank contains an electrically fired pressurizing cartridge that, when fired, provides the propellant necessary to project the napalm from the gun. Individual tanks contain about one gallon of fuel, enough for a single two- to three-second burst. Effective operating distance is said to be about forty meters. A second and third burst are accomplished by moving a selection lever on the gun. The Soviet flamethrower weighs about forty-six pounds. Three electrically fired ignition cartridges provide traditional lighting.

In a purely military situation, the flamethrower operator may not wish to risk having his position revealed by the pilot light flame. Soldiers are also not usually in the position of wanting to coat their opponents with napalm before giving them the option of retreating, frying, or surrendering. In a paramilitary context, however, a propane pilot light can be simpler and does offer the flexibility of igniting the napalm later.

Most experts agree that either the Italians or the Brazilians, depending on one's point of view, currently manufacture the world's most advanced flamethrower. Both are capable of seventy-meter (215 feet) ranges. The LC-T1-M1 Brazilian model has three tanks and weighs thirty-five kilos fully charged. Its outstanding feature is an electronic ignition system powered by eight standard 1.5-volt dry cells. Reportedly, a fresh set of batteries will light one thousand shots before going dead. On the average, users expect five to seven seconds of actual operation before the fuel is expended.

The model T-148/A Italian flamethrower also has an electronic ignition, and its manufacturer claims it will function satisfactorily under water! This may be of value on rainy or snowy days. The Italian model's advanced tank design gives it the same basic fuel load as most other models, but with a total weight (filled) of only twenty-five and one-half kilograms—as opposed to most other models weighing in at around thirty-five kilos.

Problems inherent in the military application of flamethrowers—availability of proper chemicals, a ready source of fuel, and difficult-to-maintain compressing equipment—are either alleviated by civilian models or not as serious to survivors who have better access to chemicals and fuel and aren't as mobile as an army on the move. Civilian paramilitary models use smaller engines and pumps instead of high-pressure tanks and are generally simpler and more effective than the rugged, more reliable three-tank military models. Lighter civilian models can use thicker napalm, which allows greater throwing distance. Most important, the civilian unit can be

deployed and field-served without large amounts of sophisticated support equipment. Those who are not satisfied with the pilot-light ignition standard on civilian models and who are electronically adept may wish to design and construct a sparking system for their homebuilt dragons.

For the foreseeable future, flamethrowers will be with at least some elements of the world's armies. And, as was true in the case of the U.S. Marines at Munda, flamethrowers may provide exactly the same deterrent for civilians wanting to protect their urban safe havens.

CHAPTER 15

CONSTRUCTION OF A FLAMETHROWER

Builders of flamethrowers should keep several basic guidelines in mind throughout the process of construction and use. Chief among these is the fact that flamethrowers—especially the smaller, portable, expedient models—can be very dangerous. Larger commercial models (as recommended and described in this chapter) include a number of design features that make them relatively safe to own and operate. Amateur assemblers should keep these safety features in mind as they alter or modify their own weapons to accommodate surplus or scrounged components.

GIs who are assigned to flamethrower duty do not consider it particularly desirable or even rational. Handling one is intrinsically dirty, disagreeable, and dangerous. They consider flamethrowers to be weapons of last resort, useful when nothing else is at hand to do the job.

Makers who want a flamethrower for commercial applications—including starting fires, disinfecting buildings, destroying trash and refuse, or just cleaning up—should in all cases choose the more durable, conservative model. Those who want an inexpensive version principally to use in an emergency to defend their retreat could opt for a simpler design.

Flamethrowers, when viewed as a collection of their parts, are extremely simple. They consist of the following components:

1. Pump needed to propel the thickened petroleum. This pump adds cost and weight to the package but gives the machine greater utility over many military models, making it more valuable to survivors.
2. An engine, pressure tank, or other device used to power the pump. Military models use heavy, cumbersome pressure tanks. Expedient or commercial models work best with a small two-cycle engine. Miniaturization of these power plants in recent years has made it possible to develop even smaller flamethrowers.
3. Spray nozzle or gun that disperses the napalm, allowing the user to propel the napalm out onto the target. For safety and accuracy, the gun must include a forward hand grip.
4. Lighting mechanism used to flame the napalm after it leaves the hand-held gun.
5. High-pressure hoses necessary to transport the thickened hydrocarbons from tank to pump to gun.
6. Pressure valve to allow the pump to recirculate the napalm back into the storage tank when the pump pressure is not relieved by pulling the gun trigger. Some builders may want to include a pressure gauge so that they can know precisely what the system is doing.
7. Napalm fuel storage tank. To a major extent, this component is the limiting factor of any flamethrower design. Ideally, the tank should be as large as possible to pro-

vide as many shots as possible. However, weight and maneuverability considerations preclude anything much greater than 10 or 12 gallons on a backpack design or 135 gallons when mounted on a small truck or all-terrain vehicle. Using longer delivery hoses, the truck-mounted design—which at first seems cumbersome and basically immobile—can be of great tactical value.

8. Clutch or engine/pump coupling. This connection can be very complex. In some cases, the engine will run slowly enough under load to allow a direct link. However, for safety reasons, the user may demand an electric clutch that engages only when the gun trigger is pulled. In still other cases, the builder will find that he must purchase an expensive speed-reduction unit.

Using the above component list, the builder should start with the mortar and pump. Large commercial units employ a standard eleven-horsepower Briggs & Stratton electric-start gas engine. Models 221400, 252400, or 254400 are all acceptable. Tecumseh model 912210B at 12 horsepower is also an excellent choice for heavier, truck-mounted commercial units.

These larger engines don't have

to be electric start. Yet on many commercial applications, users often enjoy the simplicity of punching a button to start the power plant. Scroungers can use a four-cycle engine from an unused riding mower, generator, farm implement, paint sprayer, compressor pump, or other available power plant.

Those wanting a smaller portable unit may elect to use a 3.5 horsepower, two-cycle engine, such as a Tecumseh model 800110, available new from Graingers Supply. These are pull-start, direct-drive engines that are eminently suitable for smaller flamethrowers.

Since these new engines purchased from farm and ranch supply houses and/or wholesale hardware dealers can be quite expensive,

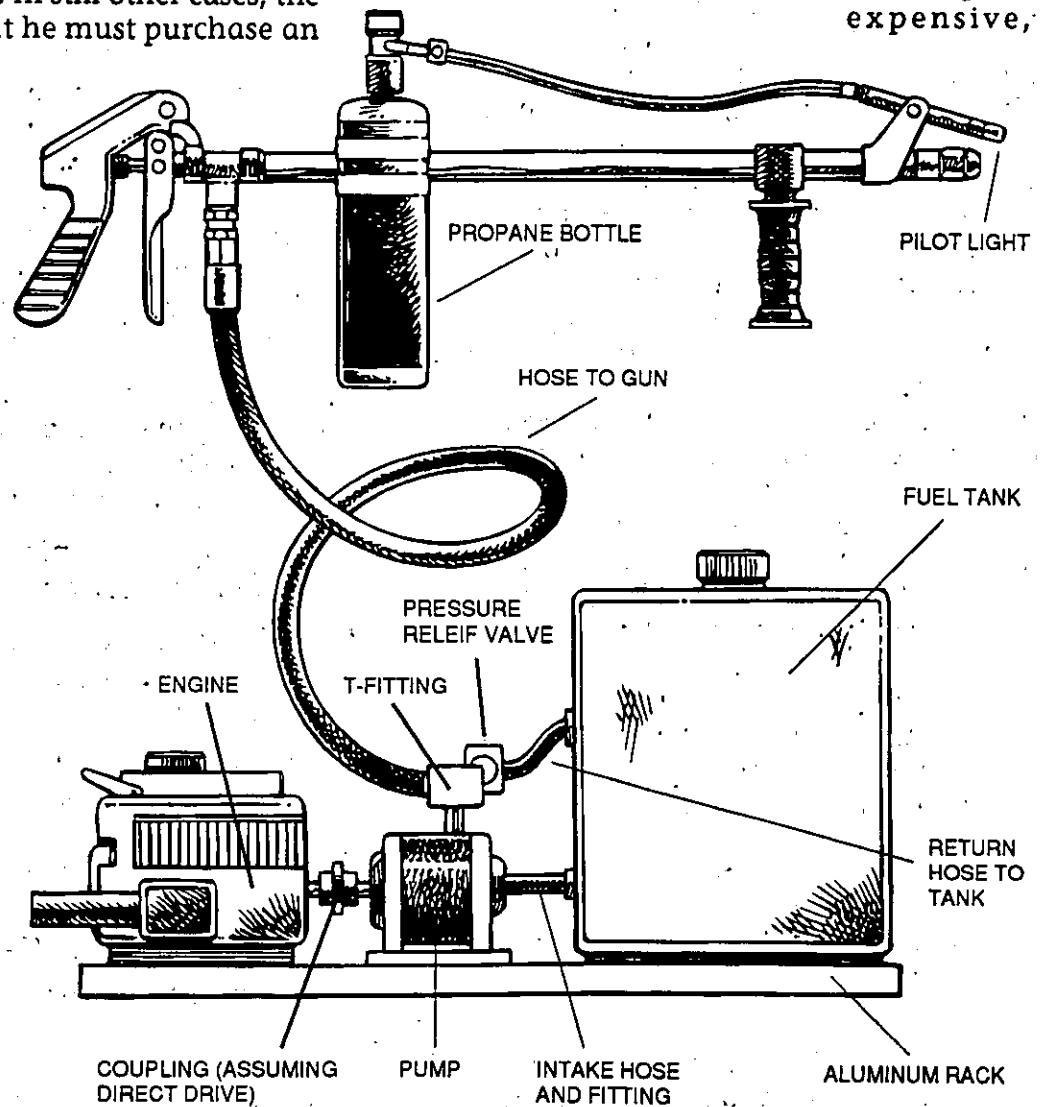

Component parts of flamethrower.

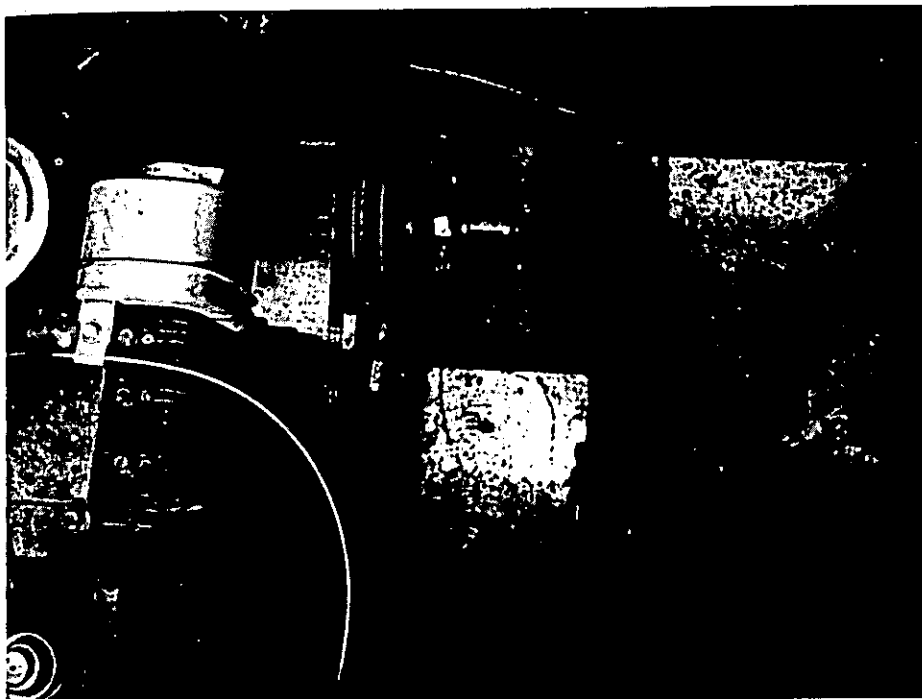

Portable flamethrowers may use smaller, lighter engines directly coupled to the pump.

survivors may elect to use a small surplus chain-saw or go-cart engine. Although many pump manufacturers claim that a unit as small as one-half horsepower will run their pumps at or near full capacity, survivors must still exercise caution so that the marriage between engine and pump is a good one. Scrounged power plants must possess sufficient remaining life to operate the intended pump moving heavy, viscous napalm.

Chain-saw engines having a 3.1 cubic inch displacement theoretically have about 3.4 horsepower. Larger, more desirable 4.9 cubic inch displacement models will have in the neighborhood of 6 horsepower, which is sufficient zip to adequately power most pumps and to get the napalm out to where it can do some beneficial work. Three-and-one-half horsepower will work, but the spray-gun orifice must be reduced so that sufficient pressure can be developed, which limits the amount of material that can be delivered. As a general rule, the unit should be run on pressures from 90 pounds per square inch (psi) to a maximum of 125 psi. Beyond this

point, delivery performance is not increased.

My own supersafe model uses a Continental Belton Co. model B0201 pump with brass gears. This pump, available from many automotive supply houses, is virtually product specific for napalm. The survivor can also choose from a host of other suitable pumps. Graingers lists a number of cast-iron or aluminum rotary gear pumps that will handle viscous No. 2 through No. 6 fuel oil. Most farm supply houses also have lighter aluminum-bodied gear pumps designed to handle chemicals and petroleum products. Specialty engineering supply

houses, such as McMaster-Carr, stock extremely light plastic epoxy or bronze body pumps with impellers that are specifically designed to move petroleum products. Some of these pumps are designed to operate using engines as small as one horsepower or less.

Anyone with sufficient funds can buy a suitable new pump. Those whose resources limit their acquisitions to scrounging may spend a bit more time looking for a pump that will reliably handle heavy petroleum-based material without dissolving or detonating the entire apparatus.

Connecting the pump to the engine is probably the trickiest procedure involved in assembling the various parts of a flamethrower. Tried and true safer commercial models use an Everco A8433 electrically engaged clutch. These clutches are cumbersome, heavy, and expensive. If purchased, successful operation requires that these units have a wet-cell battery wired in as a permanent fixture. An A8433 clutch can be scrounged from an old Ford automobile air conditioner system. They are used in conjunction with a microswitch wired into the



Eleven-horsepower gas engine (left) powers pulley/clutch assembly (center). The electric clutch is taken from a Ford automobile air conditioning system. Pump on far right is a bronze gear-type, designed to handle thick petroleum products.

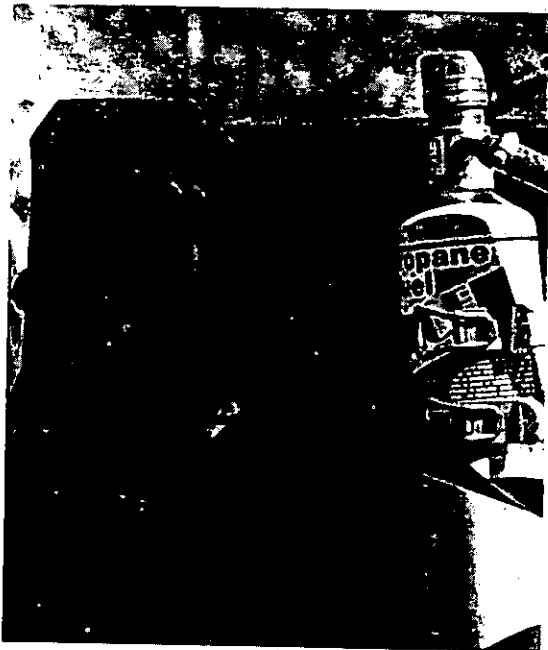

Electric microswitch to machine clutch (arrow) and propane bottle are mounted on the gun barrel extension. Pulling the trigger engages the microswitch, which activates the clutch, thus propelling the napalm.

gun trigger so that the hoses carrying the volatile napalm are not under constant pressure. Pulling the trigger kicks in the clutch, putting the engine under load as the pump pushes the snotty napalm down the hose.

On smaller, more expedient models the maker may elect to run the hoses under constant pressure. All hoses must be the high-pressure type, double fastened at all connections. Makers should also install a good pressure-release valve that will allow excess napalm to be recycled back into the storage tank. This recycling process prevents the user from having to mix the napalm in a separate container and then empty it back into the flamethrower tank.

Most gear-type pumps require about 2,000 revolutions per minute (rpm) to perform satisfactorily at full pressure, with something approaching full delivery potential. New commercial engines run wide open at about 3,600 rpm. This would suggest that a direct-drive system avoiding heavy pulleys and belts would not be feasible. However, in actual practice most pumps will accommodate higher rpm, while smaller engines under load seldom run at a full 3,600 rpm. It all depends on the engine and the pump. Builders will find that they must field engineer their specific pumps and engines to

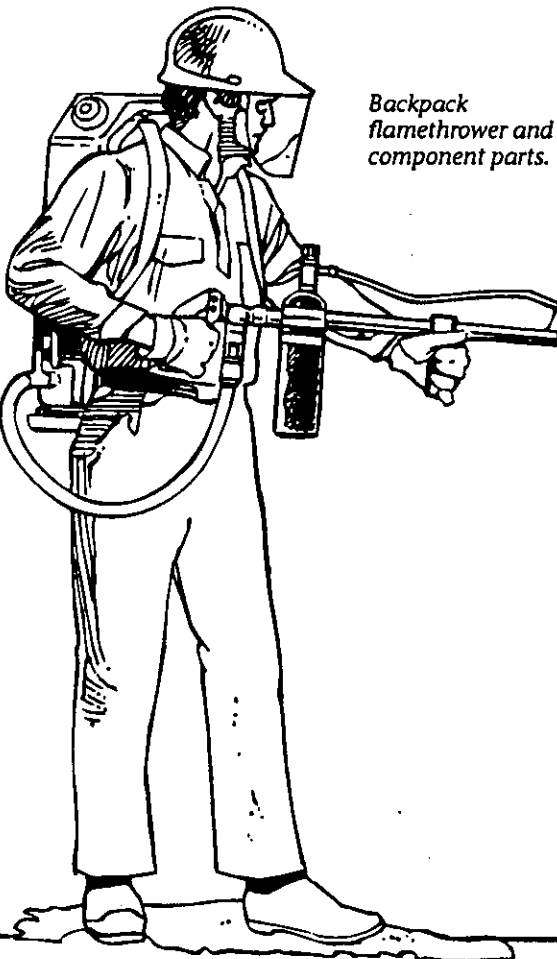

Backpack flamethrower and component parts.

achieve the best results. Theoretically, engines running at 3,600 rpm that are geared or belted back 50 percent to 1,800 rpm have twice the torque and would be expected to perform more suitably. In actual practice, this is not always true. Some surplus chain-saw engines run faster than 3,600 rpm and absolutely must be geared back to be effective.

Before I set up a belt and pulley system or purchased an expensive reduction coupling, I would try a simple collar, hooking up pump and motor face-to-face. This simple, cheap approach is preferable unless the survivor's needs require the safer, more conservative model, necessitating the use of an electrically engaged clutch.

Once the pump and engine are matched, the unit must be bolted to a small aluminum-angle carrying rack. I use four 1-1/2-inch aluminum angles. Since most survivors cannot weld aluminum angle, the pieces must be cut to size, drilled, and then bolted together. Aluminum angle is ideal because of its weight, ease of handling, and nonsparking nature.

As a general rule, pumps used for flamethrowers will be engineered with 1/2-inch pipe intake and output ports. Securely thread a 2-inch black pipe nipple into the output port. Onto this nipple, securely thread a common black 1/2 tee. All pipe fittings must be in excellent condition. Into one side of the tee, thread either a preset or adjustable relief valve. Set the relief valve at 100 pounds of pressure or use a preset version of that strength. Past experience indicates that 100 psi is about maximum for a

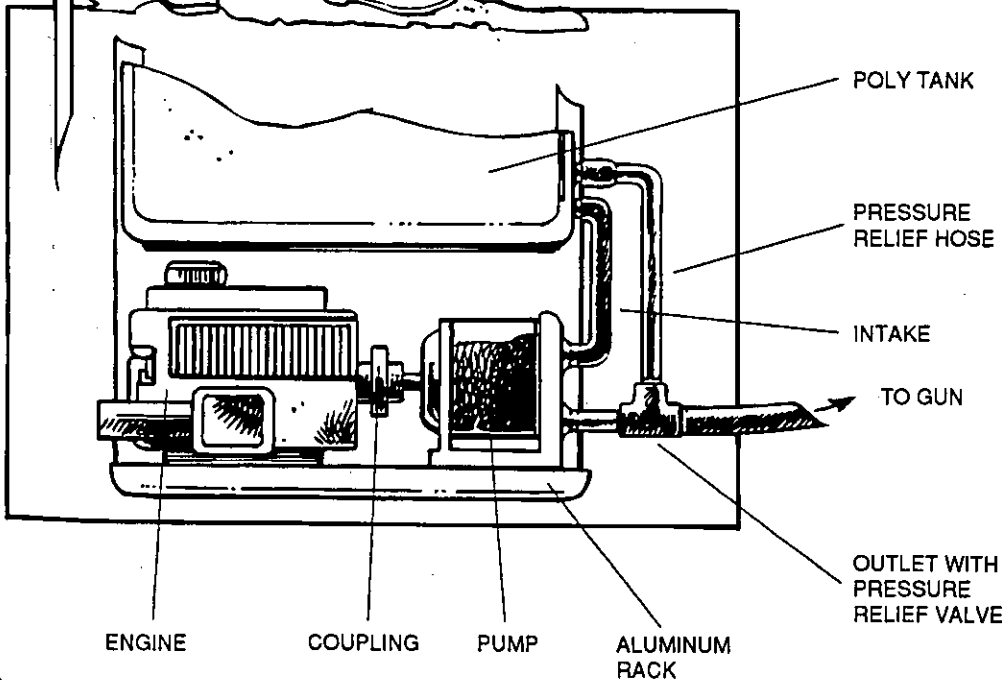

ENGINE

COUPLING

PUMP

ALUMINUM RACK

POLY TANK

PRESSURE RELIEF HOSE

INTAKE

TO GUN

OUTLET WITH PRESSURE RELIEF VALVE



Eleven-horsepower, four-cycle engine powers the pump, which is connected through the electric clutch. The motor is belted to slow it from 3,600 revolutions per minute (rpm) to 1,800 rpm. The battery (shown in upper left) partially supplies the power to activate the clutch and start the engine.

flamethrower. At 125 psi we start to lose distance and efficiency, while below 90 psi performance drops dramatically. As the engine builds pressure in the system, the valve will open, allowing the napalm to cycle through the tank. Commercial models are constructed with permanent ball valves built into the system that, when opened or closed, allow the material to be cycled to the tank, the gun, or in some cases an external tank, such as those used on helicopters.

Throughout the system you should use high-pressure spray hose designed for agricultural use, including petroleum products. Design working pressure should be 600 psi or more. This hose is commonly available at full-service farm or automotive supply houses. Suppliers will press on appropriate fittings to the specification of the builder. It is possible to obtain three-eighths-inch inside diameter hose for use over one-fourth-inch pipe fitting or three-fourths-inch pipe over one-half-inch nipples, but these require double hose clamps and are not as secure as pressed factory fittings.

Use the largest inside diameter hose avail-

able. Do not settle for anything less than one-fourth-inch. On larger models, the three-fourths-inch hose is expensive to buy and cumbersome to use, but on smaller, expedient models where hose lengths are limited, this price/utility problem seems minimal. Three-fourths-inch hose delivers more napalm and fits tightly over a one-half-inch pipe nipple, making it the hose of choice if the builder can work it out.

Storage tanks don't pose as severe a problem as one might initially think. My large commercial unit uses a 135-gallon tank made from welded aluminum sheet. Other units use 55-gallon surplus poly barrels with movable hoses. For one small portable unit, we

scrounged a 12-gallon poly tank from an orchard sprayer. Since the tanks aren't pressurized, they must meet only one specific criterion: they must be nonsparking.

Poly and fiberglass tanks are especially easy to work with since most come with secure caps and can be easily fitted with suction (on the bottom) and discharge (in the top side) fittings using epoxy and/or fiberglass kits. Even common tap-and-die fittings can be placed on a poly tank as long as the tank will not be subjected to destructive pressures.

From the second T-outlet on the pump, run an appropriate length of pressure hose to the gun. The outlet tee on the pump now has one hose running to the back of the tank through the relief valve and another to the gun. Commercial semistationary models are generally built with fifty-foot gun hoses so that the user can walk around. On backpack models, four feet of discharge hose may be adequate, but a longer hose of up to twenty-five feet is more practical so that the user can set the unit down, pull the starting cord to ignite the engine,



This flamethrower has a 135-gallon aluminum tank with gun and hose attached for transport. The motor and pump are located to the right, under the sheet aluminum shield.



Flamethrower gun is attached to a truck-mounted commercial motor, pump, and tank by a twenty-five-foot high-pressure hose.

and then crawl around relatively unencumbered with the flamethrower gun. When connecting suction hoses from the bottom of the tank to the pump intake, inspect carefully to make certain that all connections are secure.

Finding and assembling a high-pressure

gun is the last task facing the determined paramilitarist. Once this is done, the user can be reasonably confident that he can defend his retreat against heavy-duty hardware.

Most full-service farm supply stores will carry a number of high-pressure spray guns. Ask for a model that will handle highly viscous petroleum products. The gun should accept an eighteen- to twenty-four-inch barrel extension. The nozzle should be capable of handling at least two and one-half gallons per minute at 500 psi. These pressure and volume requirements may seem excessive, but they do allow for some margin of

error when handling fairly dangerous materials.

If possible, use a gun with a drop-forged brass body with positive nondrip trigger action. The gun must accept a twenty-four-inch barrel extension. Using a flamethrower

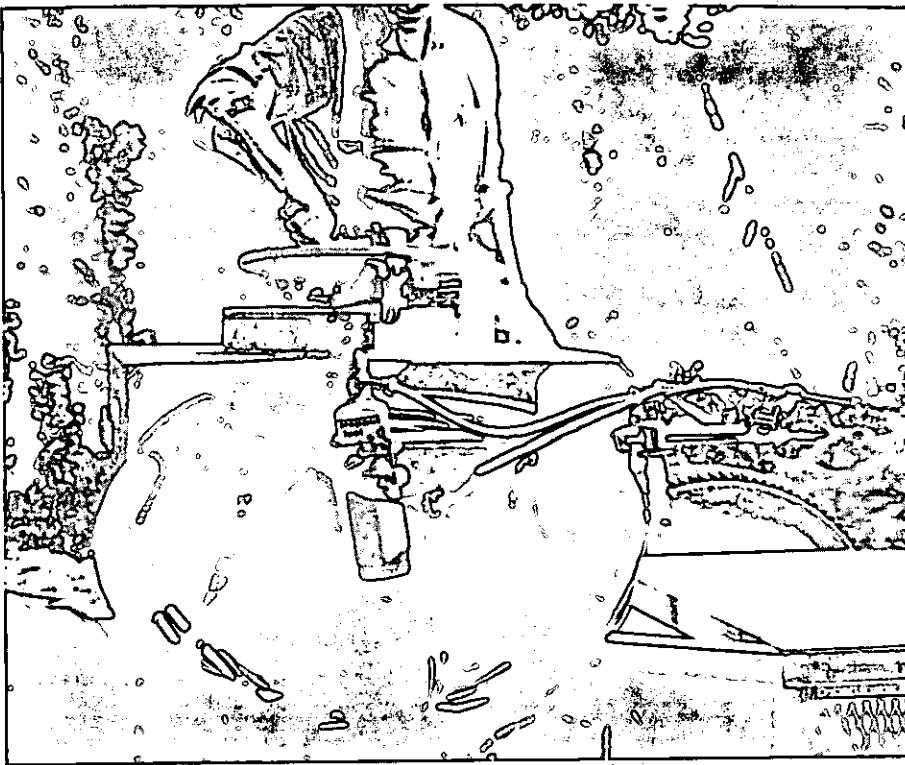

The spray gun on this model features an electrically activated microswitch to engage the engine pump.

Every high-pressure gun maker seems to have his own set of nozzles and nozzle codes. At times, I have had to call the distributor or factory to get appropriate numbers, which causes long and exasperating delays.

Commercial models that have a battery as an integral part of the assembly are drilled and tapped so that a microswitch can be placed in the trigger mechanism of the gun (suitable switches are available from Radio Shack or other electronics stores). Pulling the trigger also engages the electric clutch between the pump and engine. Electric lines from the battery to the clutch must be run up the hose, adding marginally to the total weight. Pressing the switch results in a momentary

without an extra-long barrel to keep the discharge away from the user is foolish and dangerous. The barrel extension also provides a place to mount a forward hand grip for the user to hold onto, as well as a mounting plane for the pilot-light assembly. The forward hand grip should be mounted at a comfortable place on the barrel using U-bolts or hose clamps.

Setting up one's hoses to adequately and safely attach to the gun, as well as fitting the unit with appropriate nozzles, can become an expensive, time-consuming exercise. To find the correct nozzles for a specific gun, the only method seems to be trial and error.

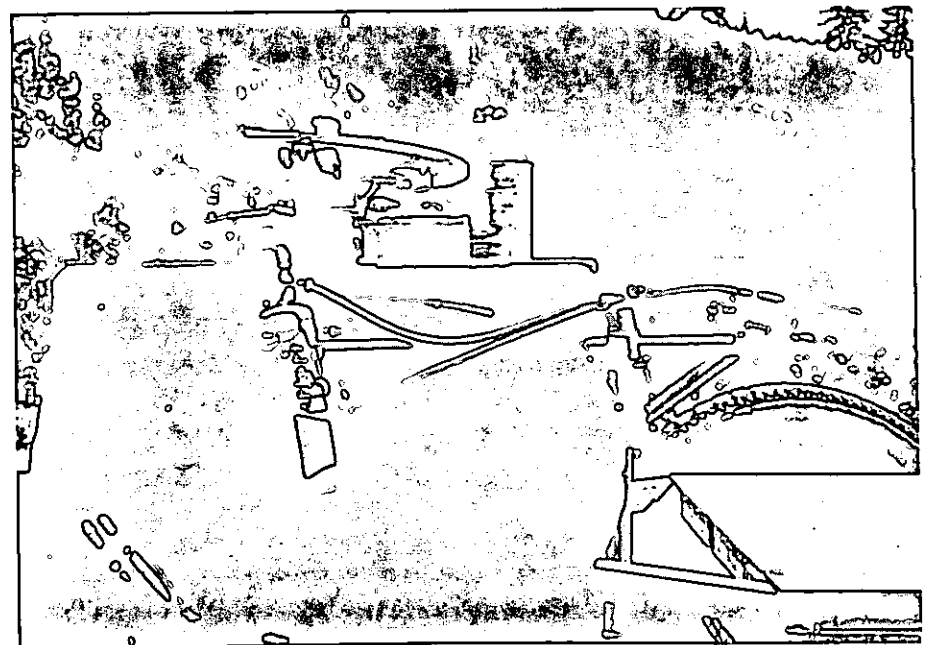

A completed flamethrower gun is mounted on the rack of the fuel tank. Note the angle of the pilot-light tube at the end of the gun barrel extension.

cause as the system builds enough pressure to expel napalm over its design distance.

Before installing the pilot light, be absolutely sure the machine will operate reliably without leaks or spills. Extra care taken in the assembling and mounting of the pilot light will eliminate or minimize problems that might otherwise arise. One trick to remember in mounting the pilot light is to position the flame at least four inches away from the discharge port on the gun. This almost always entails using a piece of copper pipe to extend the flame to its correct position. Use a common propane cylinder fitted with an extra-long nozzle assembly. Hose-clamp the proper cylinder in a balanced, easy-to-use position back on the gun-extension pipe. Keep the tank at least twelve inches to the rear of the discharge nozzle. Run the piece of copper extension from the cylinder regulator up past the end of the gun. Aim the flame down at a twenty-degree angle through the stream of napalm.

Turn the cylinder on and adjust the flame so that it is bright and vigorous. Users will discover that it takes several four-hundred-gram cylinders to keep their dragons running for any length of time. Gas consumption can be cut by turning the flame down so that it is barely visible when not actually in use. However, the wise user will plan for rapid depletion of his LP gas supply and have extra canisters available.

After confirming that the engine and pump are properly matched, the next step is to mix the napalm and do a trial run. Successfully mixing napalm is much more difficult than one might expect, especially when the proper commercial chemicals are unavailable. (Since the quality of the fuel is the principal determinant of the flamethrower's effectiveness, the next chapter is on fuel-mixing procedures.)

By whatever means, make certain that you have thoroughly tested the pump and engine as a napalm slimer before even thinking about turning on the burner. Check for leaks or spills anyplace on the device. If any fittings

show signs of leaking, do not economize on parts. Remove the defective parts and start anew. As an added precaution, I would recommend setting backpack flamethrowers on the ground before deploying, unless an emergency dictates otherwise.

Prices may vary a bit from place to place, but when assembling a dragon, the following budget should be close, although perhaps a bit on the high side:

12-HP electric-start gas engine	\$400
High-pressure bronze gear pump	100
Gun fitted with electric pressure switch	100
Electric clutch assembly	150
Industrial grade hose (50 feet)	65
Surplus poly tank (55 gallon)	25
Aluminum frame material	15
Battery	50
Fittings and wire	25
Total	\$930

Add another \$20 if a new pack frame for a man-portable unit is needed. Total price would still be well under \$1,000, a small price to pay for something that would easily take out an armored car.

People who enjoy puttering around with devices of this sort can usually pick up all of the essential components at greatly reduced prices. Using a surplus chain-saw engine and farm chemical pump will usually keep the price under \$500. At one time, I even found an adequate gun among some old farm supplies that was fitted with a barrel extension, pressure switch, and new nozzle for use on a portable unit. The only used components you should avoid are high-pressure hoses and pressure-relief valves.

Although novice builders generally overestimate the amount of money needed to make a flamethrower, they generally underestimate the amount of time needed to scrounge and construct their first unit. Assuming one has access to a well-supplied agriculture or auto-supply store (and a lot of cash), a good estimate is about one solid week the first time through, using all new parts.

CHAPTER 16

MANUFACTURING NAPALM

It seems like a thousand years ago, but I can vividly recall as a kid crouching next to a three-gallon lard can half-filled with gasoline that I was heating on a small camp stove. I was trying to make napalm following instructions from an old World War II Office of Strategic Services (OSS) operations manual. The incident occurred so long ago that most of the details are blurred. For instance, I don't remember exactly why I was trying to make napalm. I do remember that I had no practical use for it; we didn't own a flamethrower, and I had no idea how to construct one. One thing is very clear to me, however. Even though I was operating upwind of a steady breeze, I remember my sixth sense kept telling me this was really a very dangerous, dumb thing to do.

Every time I put the can on the fire, the gasoline started boiling furiously. Carefully and meticulously, I shaved microscopically thin slivers from a bar of 99-percent pure Ivory soap into the boiling gasoline. Eventually, most of the gasoline boiled away, leaving a brown, varnishlike sludge in the bottom of the

can. The soap never did jell the gasoline, leading me to the conclusion that there really was no such animal as an expedient napalm formula. As a result, I abandoned this project until much later in life when I discovered good, reliable commercial napalm chemicals.

Commercial users maintain that producing a good batch of napalm is tougher than building the flamethrower. The task of getting the napalm right would be virtually impossible

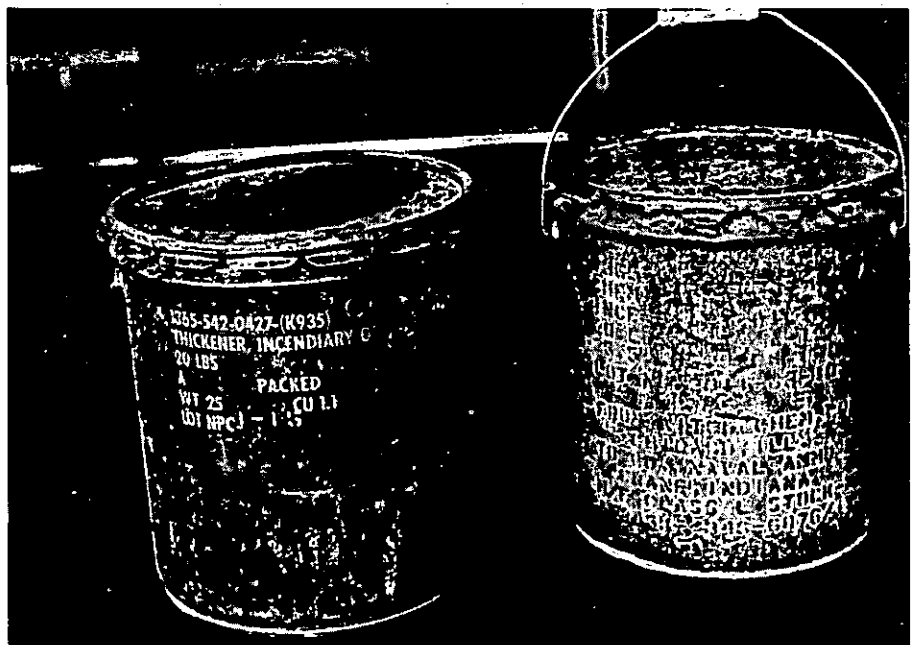

Most surplus napalm chemicals have disappeared by now. Occasionally a can of M-2 or M-4 alumagel may be found in old army surplus stores or commercial forestry supply stores. These two cans of M-4 incendiary oil and thickener were packed in 1969 (right) and 1964 (left).

were it not for the new, improved chemical formulations. However, variations in temperature and humidity still preclude the procedure from ever being cut and dried. To make matters worse, in addition to being sensitive to weather conditions, the formula is always peculiar to each individual flamethrower, as well as being subject to the availability of various chemicals.

For a number of years I used military-grade petroleum gel chemicals purchased from surplus stores, which were usually quite cheap. Invariably they came in battered five-gallon pails containing twenty pounds of cream-colored chemical. The pails were rugged, durable containers that were in and of themselves worth the forty cents per pound I usually paid for the chemical inside. The chemical was called alumagel, and it came in two distinct varieties: M-2 for use in warm weather (defined as temperatures above 60°F) and M-4 for cold-weather use. I carried both M-2 and M-4 to the field for testing, and it was usually a toss-up as to which formula would perform best on a given day. As a general rule, it always took considerably more chemical of either type to achieve the desired performance when temperatures were at the lower end of the range.

Assuming alumagel is still sold in a surplus store near you, I recommend the following percentages as a starting point:

Fuel/gal.	M-2/lbs.
55	10.00
40	6.75
30	5.00
25	4.50
20	3.40
15	2.50
10	1.70
5	.81

M-2 (warm-weather alumagel) is for use when temperatures exceed 60°F. When the temperature falls below 6°F, flamethrower operators must switch from M-2 to M-4 alumagel. Use the following ratios as starting points for a cold weather M-4 mix. (All ratios

are approximations that must be adjusted for local conditions.)

Fuel/gal.	M-4/lbs.
55	6.70
40	4.50
30	3.75
25	3.00
20	2.30
15	1.75
10	1.20
5	.60

Generally, five to fifteen minutes of mixing time will be required to whip up a batch of gel. Using the above ratios, begin with a small amount of fuel to try the formula. Sift the alumagel through a screen to break up any lumps that may have formed because of high humidity or long storage. Caution: you must sift all of the recommended amount of alumagel into the fuel on the initial pour. Adding extra alumagel powder later to correct a runny formula causes uneven distribution of the powder in the fuel, producing napalm that is too thick, ropy, and lumpy to be usable.

Those whose dragons will mix the napalm by running it through the system can expect a far superior product of much smoother consistency than that which results from stirring it in a tank with a paddle. Too much alumagel sifted into the base fuel creates a final product that is beyond the capabilities of the dragon's motor and pump. Should this happen, wait ten minutes to be sure it has completed the jelling process and then mix in two to three additional gallons of gasoline—assuming that this is a twenty-five to fifty-five gallon starting batch. If the test batch is five gallons or less, one-half gallon of additional gasoline should thin the batch sufficiently to run through the machine. Always use gasoline to thin, never diesel fuel, even if the mixture was originally thought to be low on fuel oil.

If the gel will be carried around for several hours before using, make the mixture slightly thinner than usual. It should set up adequately after a few hours, especially in rising temperatures. Remember to circulate it through

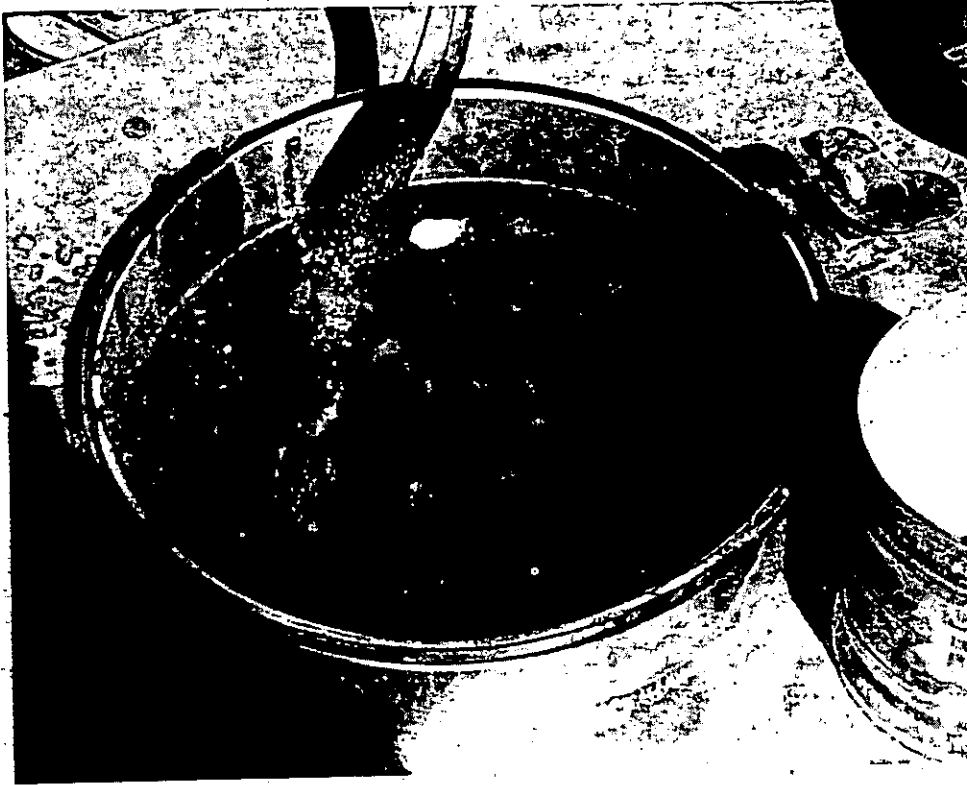

After the mixture sets, it resembles apple butter in color and consistency (above). As the mixture approaches the correct state, lumps will appear and the fuel will cling to a stick like heavy syrup (below).

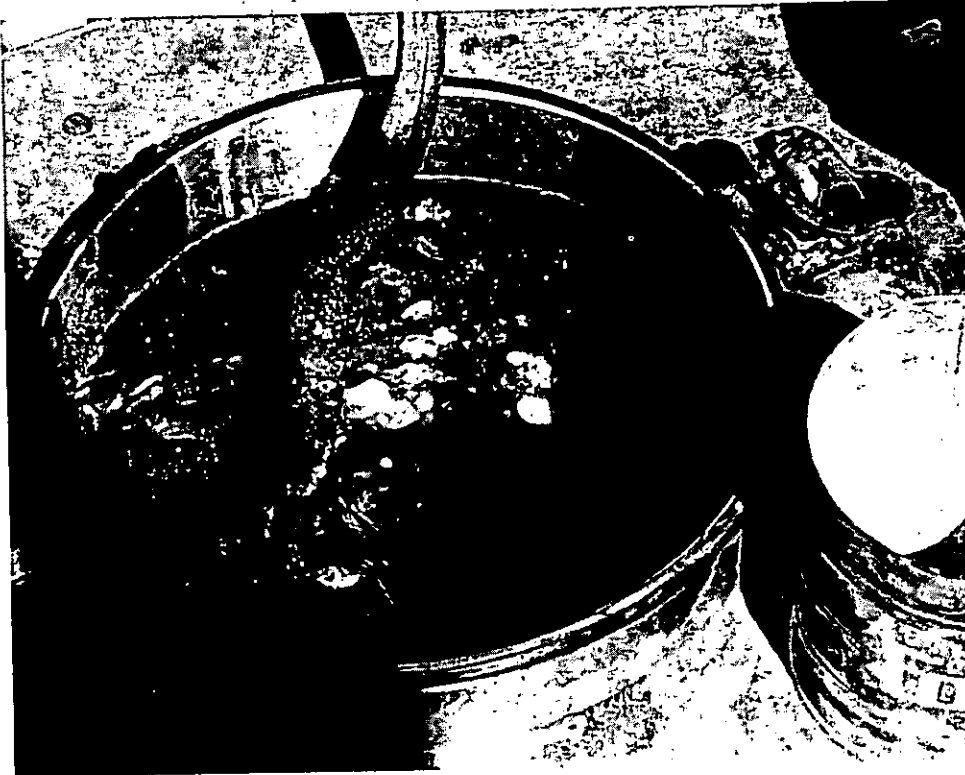

the system occasionally to produce a more stable end product.

Almost any petroleum product can be jelled. Pure gasoline will jell into a mixture

similar in color and consistency to apple butter, and it loses some of its intense volatility. Jelled gasoline burns more like lighter fuel, except it has greater endurance and body. The end product should have the same thickness and stickiness as Karo syrup, with a few floating soft lumps that look much like whipped margarine.

The best starting fuels usually combine gasoline and fuel oil. Gasoline provides volatility, while the fuel oil adds the staying power necessary to eat through body panels and plaster walls and to set vehicle engines on fire. A heavier mixture will propel farther and will splash and ricochet, causing more mayhem. My preferred formula for small portable flamethrowers is about fifty/fifty gas and diesel. Your experiments may show that a mixture of 40 percent oil and 60 percent gasoline works better on a given day. Because alumagel is extremely sensitive to atmospheric conditions, it is difficult to predict ahead of time which formula will work best.

Larger commercial units often perform best by reversing the ratios to 60 percent oil and 40 percent gasoline. Surplus JP-4 (jet fuel) is often available from aircraft fuel-tank maintenance. It makes excellent flamethrower fuel. Napalm made from JP-4 will often remain in good condition for two to three weeks. At about two weeks, napalm made from regular fuel oil and gasoline usually starts separating into a thin, watery solution or congealing into a heavy gluelike substance. Neither is usable. To test your formula's shelf life, set aside five or ten gallons for a few weeks and see what happens.

In my opinion, expedient methods of making napalm have not improved since my failed childhood experiment. I strongly recommend that you use only commer-

cial or military surplus chemicals when preparing napalm, especially if the situation is a serious paramilitary one. Some readers may develop a workable, expedient method of jelling petroleum, but at this point, I doubt it.

Military-surplus alumagel performs adequately for its intended purpose, but because it is so sensitive to temperature and moisture fluctuations, I now use a material called Sure-Fire (available from Simplex Manufacturing Co., 13340 N.E. Whitaker Way, Portland, Oregon 97230; 503-257-3511). Sure-Fire works well under most moisture conditions and in temperatures ranging from 32° to 70°F.



Sure-Fire chemical additive is the best and most expensive commercial napalm fuel additive available in the United States.

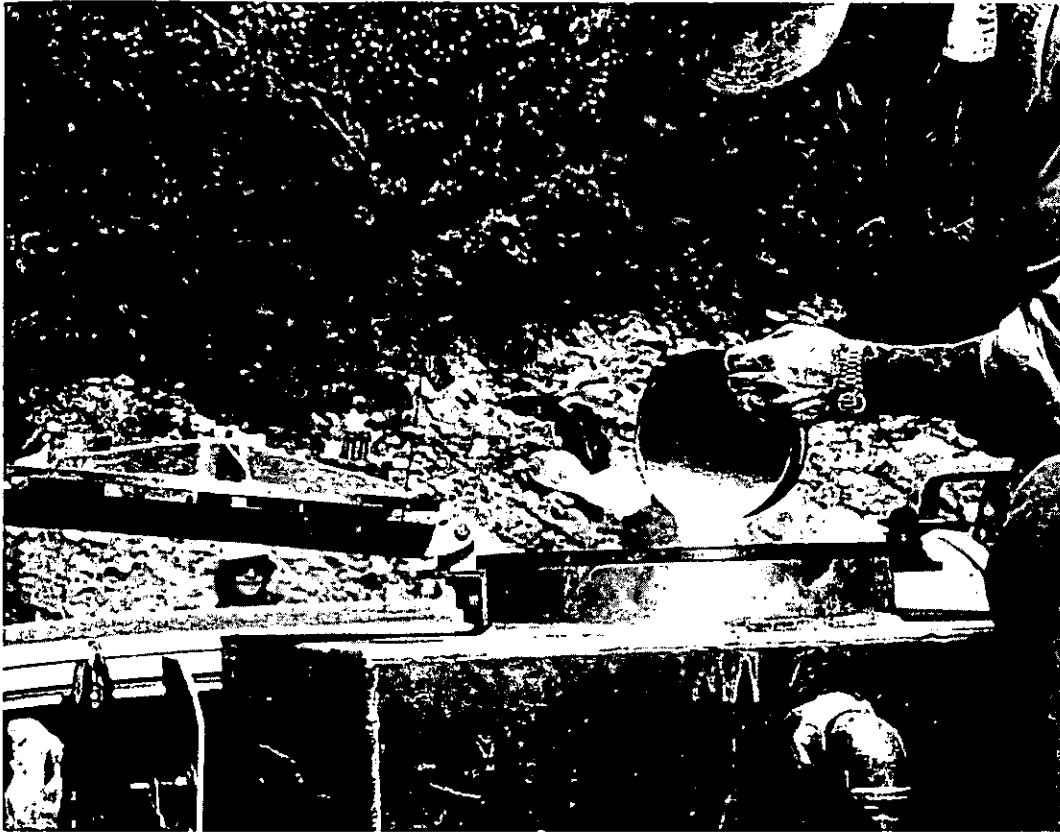

Adding a relatively small amount of Sure-Fire to the tank of a truck-mounted flamethrower produces napalm in about twenty-five minutes.



The pump on the flamethrower is set to circulate the solution for a superior mix. All of the chemical additive must be dumped evenly into the fuel at the beginning, before jelling begins. After the initial mixing, the fuel and additive must be agitated until a good, thick gel results.

Warming or cooling the fuel does not seem to affect Sure-Fire, nor does it seem to matter

which fuel or fuel mixture is used. Sure-Fire is slightly sensitive to excessive humidity, but

tightly sealing the bag between use greatly minimizes the moisture problem.

As do all "miracle" products, Sure-Fire has a downside. While alumagel costs between forty cents and one dollar per pound, Sure-Fire costs a minimum of four dollars per pound. As an added disincentive (in case this didn't make up your mind), Sure-Fire is almost always sold in fifty-pound bags. Western Helicopters (Box 369, Newburg, Oregon 97132; 503-538-9469) will occasionally ship smaller quantities. Contact them directly to find out about selection, price, quantity, and shipping instructions. Both Western Helicopters and Simplex are basically farm and logger supply houses, so inquiring about Sure-Fire will not generate concern or hostility, provided the inquirer maintains the posture of having an agricultural or forestry use for the material.

Sure-Fire is used in far smaller quantities than alumagel, mitigating its cost per pound somewhat. One-twentieth of a pound (at a cost of about twenty cents) will usually jell one gallon of regular gasoline and oil mixture in about twenty-three minutes. If the temperature drops below 30°F, it may take two-thirds of a pound per gallon to do the job in the same time.

Plan to use three pounds of Sure-Fire in thirty gallons of fuel to jell the mixture in twenty minutes at 50°F. As with other products of this nature, Sure-Fire must be sifted gently into the fuel to avoid caking, roping, and lumping. Using the flamethrower's pump to circulate this

mixture is the preferred method of mixing, assuming one's dragon has this internal ability. Note that with all chemicals of this nature, these figures are to be used only as starting points. Intelligent users will experiment to find suitable mixtures that perform well in their weapons. Owners are looking for a formula that will give them the longest propulsion, hottest burn, and most sustained jell.

Experienced fire fighters wear Nomex pants and shirts when working around flamethrowers. It may not be necessary to wear this special flame-resistant clothing, but it is imperative that users never wear synthetic clothing—including nylon, rayon, or polyester of any sort—when using a dragon. When subjected to high heat, synthetics melt to one's skin, subjecting it to ugly, painful burns that would not result from natural fabrics.

When trying the flamethrower for the first few times, be especially cautious that errant breezes do not send the napalm arcing back onto you. It is always best to throw the napalm with the wind, but this may not be possible, especially from a defensive position. In the case of an upwind attack, try to operate from an uphill position. After some trial runs, it may even be necessary to install a different, more appropriate orifice in the gun.

Mixing suitable napalm, even with a superior product such as Sure-Fire, is more an art than a science. Determined survivors who elect to use flamethrowers must decide ahead to invest enough money and time to do the job properly.

CHAPTER 17

INTRODUCTION

The American Civil War had been over for only two years in 1867 when an otherwise obscure Swedish chemist discovered that mixing capricious, powerful, and dangerously unstable nitroglycerin oil with inert, otherwise innocuous, diatomaceous earth produced a reasonably stable material of immense benefit to mankind. The world named the stuff dynamite.

A highly unpredictable substance, nitroglycerin had been around since its discovery by Ascanio Sobrero, a ho-hum Italian chemistry professor who, in 1846, treated common glycerin with nitric acid. To produce an explosive, the challenges were to make the explosive substance pure enough so as not to self-detonate on the shelf and to stabilize it to the point that the explosive could be transported safely to the work site, where it could be detonated on command.

Because of its vastly superior explosive qualities vis-a-vis black powder, heroic attempts were made to use raw nitroglycerin oil for mining and, to a limited extent, for various uses during the American Civil War. The substance, however, had a maddening habit of going off prematurely without immediate, apparent cause other than a slight warming of the weather, and of being so sluggish at temperatures under 55°F that it could not be detonated under any circumstances.

Alfred Nobel's fortuitous mixture, in addition to numerous tangential discoveries he also made in the field of explosives engineer-

ing, led to the technological shifts that, in economic terms, were of equal importance to the power loom, iron plow, or even the steam engine. In an economy that increasingly eschews the use of dynamite, a surprising 50 million pounds were used in the United States as late as 1985.

At this point, a good definition is in order. All chemical explosives are divided into two classes, high and low. Low explosives include black blasting powder of various types, chlorate powder, and other similar products that burn rather than detonate. Low explosives are seldom used to do commercial blasting.

High explosives decompose with high reaction rates having significant pressures. Conversion from solid to gaseous state is almost instantaneous. As a result, their shattering force is great. High explosives are used whenever large amounts of force are required. Dynamite is the best, most common example of a high explosive.

Without the shocking, tearing effect that is at least twenty times as great as that of dynamite's weak sister (black powder), societies and cultures cannot build roads, bore tunnels, extract minerals from deep in the earth, clear harbors, build railroad beds, or even perform such mundane tasks as laying sewer lines, digging foundation trenches, or excavating holes for outhouses.

Eight ounces of high-tech dynamite stores the potential of about 600,000 foot-pounds of

energy. Properly harnessed and directed, that is enough to throw a ten-pound projectile eleven miles, or represents the total muzzle energy of two hundred 30.06 rounds fired simultaneously.

There is a modern tendency to dismiss the productive use of dynamite as unimportant in our society. From some perspectives, this assumption is understandable.

Substitutes such as ammonium nitrate and others have taken over much of the market for commercial, dynamite-type explosives. In another regard, the older high explosives have been dwarfed into obscurity by their super-powerful nuclear relatives. The Hiroshima bomb, for instance, contained in a cylinder ten feet long by little more than two feet in diameter, the explosive equivalent of a single stick of dynamite twelve yards in diameter and one hundred yards long.

A relatively small five-megaton nuclear weapon has the explosive equivalent of a fifty-story building covering a city block and crammed full of dynamite.

With competition like this, it is little wonder Americans forget about the role dynamite plays in our economy. Yet it is still true today that explosives use acts as a lagging indicator of economic activity. When the economy is buoyant, mines are busy, roads are being built, and airfields leveled. Explosives consumption is up. When the economy is in the doldrums, the line on the graph plotting consumption of powder angles sharply down.

By 1875, Alfred Nobel perfected the principle of initial ignition, wherein he used a small, protected charge of easily degraded black powder to detonate a more stable main charge comprised of high explosives. We use the concept every time we set up a cap and fuze to produce a detonating stick. The concept is revolutionary in its significance but was completely unknown before Nobel's time. He actually pioneered the concept of initial ignition before he developed dynamite!

Early explosives engineers even thought in terms of rigging up a mechanical hammer with which to detonate a primary charge. Like many

simplistic technological jumps, the discovery of initial ignition tends to be lost in history.

Alfred Nobel made millions in his lifetime supplying good, reliable explosives to the world's economies. He was popularly pilloried as a "merchant of death," but contemporary records indicate that little use of dynamite was made in a military context.

Perhaps in response to the adverse PR, Nobel funded the now widely recognized Nobel Peace Prize. Few realize the source and background of the prize that rewards outstanding work in the fields of physics, chemistry, medicine, literature, and fraternity between nations. Ironically, Nobel predicted that high explosives would eventually make wars so costly that they would cease to occur. Technological advances in the field of high explosives in the late 1800s had a high price. Alfred's older brother was killed April 12, 1888, in an explosion at their dynamite factory at Helenborg, a few kilometers from Stockholm, Sweden.

The blast was the second death-dealing event in the Nobel family history. In September 1864, Nobel lost his younger brother Emil when his nitroglycerin factory went up, taking four employees and the young man with it.

Under pressure from the Stockholm city fathers, Nobel moved his factory onto a raft that he floated on a nearby lake.

The explosion was the first of many worldwide. Nitroglycerin factories are known to have blown up in Panama, New York, San Francisco, and Sydney. This did not seem to deter a rapidly industrializing world that saw these explosives as a good answer to reaching low-grade ore deposits deep underground and for ripping rock with which to surface carriage and railroad rights-of-way.

Managers of existing nitroglycerin factories that did not detonate prematurely quickly saw the value of the new Nobel process. By mixing nitroglycerin oil with commonly available diatomaceous earth, they found it absorbed three times its own weight of the hostile liquid. Only the most determined blow, or a most

intense heat, could detonate the new form of high explosive.

Factory owners quickly added dynamite-processing lines on to their nitroglycerin factories. By 1873, there were at least thirteen major producers throughout the world, ranging from Japan to Finland.

Problems with the end product persisted, however. Watery sets tended to kill the early nitro dynamite by driving the oil out of the diatomaceous earth. Also, the product froze solid at 55°F and was extremely difficult to detonate.

The water problem was solved by judicious use of additives and by better use of cartridge wrappers. Modern dynamite is wrapped with a double layer of heavy bag paper impregnated with materials that keep water out and which assist with the overall detonation.

Ammonium nitrate, among others, was blended into the formula to give the cartridges an almost waterproof quality that is still in use today.

The problem of nitroglycerin's high freezing point was never really overcome. The solution that eventually emerged involved mixing ethylene glycol dinitrate, an antifreeze compound that is molecularly similar to pure nitroglycerin oil, with pure nitro. The result was a mixture that was much more usable at low temperatures.

There is no dynamite today that is pure nitroglycerin. Other compounds, such as calcium carbonate and nitrocellulose, were added to increase dynamite's stability as well as lower its freezing point.

Dynamite became so safe and so well accepted that virtually every rural hardware shop had at least a few sticks, a box of caps, and some fuze in its inventory. Farm-supply stores sold it by the piece to those who were too poverty-stricken to buy more than that for which they had an immediate need.

The first year Nobel sold dynamite, he peddled about twenty-two thousand pounds of the stuff. The price was \$1.75 per pound. On a relative productivity scale, it was much cheaper than black powder, so mar-

keting the product was not a particularly difficult chore.

By the 1950s and '60s, annual consumption of dynamite in the United States alone was hovering around the 1-billion-pound mark. The price had fallen to ten cents per pound or, if one bought in fifty-pound case lots, the price was four dollars total.

The Romans knew how to build roads and, to an extent, how to surface them with an asphaltlike material. It took Nobel and his invention, however, to produce cement (dynamite was necessary to blast huge stones out of the Earth in small enough pieces to crush to make the cement). At the time, the United States was starting in on the largest road-building program ever to be undertaken in human history.

During the '50s and '60s, this country was evolving out of being a rural society. It was during this time that America learned to be afraid of explosives. That fear has been translated into vendor regulations and restrictions that have raised the price of powder dramatically.

Modern explosives cost about one dollar per pound or fifty cents per stick. Unfortunately, there is no longer a single-stick price. Fifty-pound cases run a minimum of fifty dollars!

To some extent, dynamite is priced on the basis of grade and strength. The strength of straight nitro dynamite (of which there is virtually none remaining today) is evaluated by its explosive oil content. For example, if the dynamite contains 40 percent explosive oil by weight, it is said to be "40-percent dynamite." Mixtures are graded by tests that establish their strength as compared to an imaginary benchmark of straight dynamite.

Grades range from the relatively tame 20-percent stuff all the way up to 85-percent dynamite, known as Hy-Drive. Hy-Drive is used to detonate blasting agents such as ammonium nitrate.

Lower-strength powder in the 40-percent range is used to push and throw, as in removing stumps and rocks from the Earth. The plan with this material is to keep the object

being shot intact so it can be hauled away after it is torn loose from its mooring. Finishing the work with as small a crater as possible is another advantage of lower-strength powder.

Higher-strength 60-percent and 70-percent grades are used to shatter rock into pocket-sized pieces and to reorganize ice jams.

Some very high grades of dynamite are used to blast channels in wet marshes because these grades will propagate, meaning that, set in a row, one charge will set off another on down the line by hydraulic shock.

It does not take a huge amount of experience to learn what strength is proper for a given application.

In the final analysis, doing the work was what Alfred Nobel had in mind when he first perfected his blasting systems. With them, a single individual can dig a disposal pit or dry well in otherwise impenetrable ground, set posts, remove large boulders, redirect creeks, cut drainage ditches, unclog duck ponds, or blow up bad guys, as well as perform a host of otherwise impossible chores of immense benefit to mankind.

CHAPTER 18

BASIC PROCEDURES

Detonating dynamite is relatively simple. Getting it to go off at the time and place one desires is a matter of straightforward training combined with a modest amount of self-discipline.

Capping a dynamite cartridge is the first, most basic skill that the would-be blaster must master.

Before proceeding, users who have never examined dynamite before should open the end of a cartridge for a firsthand look. They will find that the tan to tan-grey mixture looks like old chewing gum. The white prills (spherical pellets), if included in the mixture, should be round and firm. Mushy, distorted prills are a sign of old, going-out-of-condition powder. Don't buy this kind if you can help it. If you have it already, use it up. If the cartridges are weeping or leaking, carefully dispose of them by burning.

Cartridges come in a great variety of sizes and shapes. Nine hundred and ninety-nine times out of a thousand they will be half-pound sticks that are about one-and-a-quarter inches in diameter by eight inches long. I have occasionally used some twelve-inch-long sticks and some three-pound canisters, but only a handful of times in forty years of blasting. The three-pound canisters were special orders that I lined up for dealing with an especially dreary stump-removal project.

Approximately thirty-five fresh oak stumps dotted the middle of a fifty-acre field. We had cut out the logs the previous winter. Some of the logs were forty inches on the butt

end, which gives the reader some idea of the size of the stumps. All the logs were cut into one-inch boards. Any limbs bigger than three inches were stacked up by the stove. Other than the stumps, we were ready to farm the ground.

Usually a blaster would use a hand auger to dig down under the stumps, fire a springing charge, and then blast the stumps out with a heavy main charge. Because the stumps were so large and green, it was a tough project. The sandy, dry soil and the incredibly hot, muggy weather added immeasurably to our grief. It took immense willpower just to go out to the humidity-sodden work site, where the last fresh breeze had blown months ago.

Lightening the work load became a priority item. The plan we worked out did the job very nicely. By connecting a rotating six-foot length of cold, rolled-round steel stock to the drawbar of our D-8 Cat, we fashioned a punch that took the place of the auger. One drum of the machine's winch raised and lowered the bar, producing a very workable, power-punching dynamite tool.

By lowering the pitch of the punch to a 45° angle, we were able to back up the Cat onto the bar and drive it down under the stump. The hole it produced was just right for the three-pound canisters. We routinely pushed four or five of the cylinders of 40-percent powder down the hole with our rake handle and let 'em rip.

When we had eight or ten sets batched up,

we lit them all en masse. The little dozer operator, who had just returned from a government-sponsored hunting trip in Korea, jumped two feet every time a charge thumped. A couple of times the blasts were so close together that he didn't get to touch the ground between thumps.

Unlike regular cartridges, the three-pound canisters were packed in what appeared to be common cardboard tubes. Dynamite cartridges are wrapped in tough, deep brown paper. The slick paperlike material of regular half-pound charges is specially treated so that it will enter into the detonation. The paper ends and the seam along the cartridge are sealed with wax. Dynamite cartridges are compact and tough. As many miners can attest, they will withstand a fair amount of rough handling bordering on abuse.

Powder users will commonly encounter two types of detonating caps. Electrical caps are easily distinguished by their two red-and-white or green-and-yellow wire leads. The cap itself will be a natural aluminum color. It will have a watertight rubber plug securing the wire leads to the cap body.

The 2 1/4-inch x 3/8-inch caps are marked "Dangerous Blasting Cap Explosive" on the body. Several different styles of electrical caps are available, providing for a time lapse between firing and actual detonation. These are used in mining and quarrying to allow multicharge sets to be set off in proper sequence. Standard industry codes for these caps are as follows:

Delay Period (code)	Time in Seconds to Actual Detonation
0	0.008
1	0.5
2	1.0
3	1.5
4	2.0
5	2.5
6	3.0
8	4.0
9	4.5
10	5.0

Delay-action electrical caps are manufactured by putting a delay element with a closely controlled burn time between the ignition element and the primer charge. The primer ultimately deteriorates the cap. Standard delay caps are designed to fire at intervals of from one-half to five seconds after they are electrically "set off."

Codes used to designate the type of cap one is dealing with are fastened to the lead wires. These range from 0 (virtually instantaneous detonation) to 10 (five seconds). The delay caps are used in a way that the outside charge blows first, relieving the outside wall so that the inner charges will then in sequence crack the material being blasted free in the correct direction.

As a general rule, the hobby blaster will use only the instantaneous varieties of electric blasting caps. The only exception might occur if one buys supplies from a quarry operator or other secondary source.

Caps used with fuze were, in times past, most common because they were generally less expensive and less cumbersome to use than their electrical counterparts. Lately I have had trouble buying fuze and caps in anything but very limited quantities, due—in part, vendors tell me—to a government drive to make these easier-to-use explosives more difficult to obtain.

Fuze caps are thin, hollow aluminum cylinders one and one-half inches long and about one-quarter inch in diameter. Fuze caps are much smaller than electrical caps, even excluding the wire leads.

Unlike regular dynamite (which burns without incident for a minute or two when torched), the mixture that fills the cap up to about two-fifths of its capacity is fire-sensitive. When the fuze burns to it, an explosion about the intensity of a healthy firecracker results.

Fuze comes in white, red, and black colors depending on the whim of the maker. The feel is stiff and slick. Coils can be from four to nine inches in diameter, with lengths from fifty to one hundred feet. The fuze core burns with a hissing, spitting, smoking flame. Surrounding

the core is a sticky, tarlike layer that is, in turn, covered with a wrapping of light thread that is lightly painted.

It doesn't happen easily, but the fuze should be protected from kinking. Old timers sometimes knot the fuze around the dynamite to hold the cap in place. This procedure is a definite no-no if one wants to avoid adrenalin-inducing rushes while cleaning up messy misfires.

The correct procedure when attaching a cap to the fuze is to always trim about one-half inch from the end of the coil of fuze. Do this to expose a clean, fresh, right-angle cut to the cap.

The cut can be done with a knife but is best accomplished with a nonsparking combination cutting tool made specifically for this purpose. Dynamite combination tools are made by Diamond Tool and others, and are available for about eight dollars from dynamite distributors—usually without filling out forms.

One handle of the tool is a punch and the other is a screwdriver, which is useful when connecting drop wires to a power box. The tool is principally useful when crimping the cap to the fuze and for cutting fuze.

Crimping can be done with common gas-pipe pliers but—like many, many things in life—is best done with the correct instrument.

Knife cutting distorts the fuze a bit, especially on a hot day when the tarlike fuze is more pliable.

Insert the fresh-cut fuze end firmly into the cap. I perform this part of the sequence well away from the box of cartridges, although I have never had a cap go off prematurely.

Crimp the thin aluminum skirt of the cap securely onto the fuze. Considering that the fuze will burn at the rate of one foot per minute, that no fuze should ever be less than a foot in length, and that the extra time the extra fuze provides is always worth the price, cut a proper length off the roll of fuze.

Always be very cautious about the springy fuze snapping the cap around into a rock or other hard object and detonating it.

Using a one-quarter-inch wooden stick as the pick, or the dynamite tool, push a diagonal hole

down through a dynamite cartridge, starting about one-third of the way down the stick.

Be cautious not to run the hole through both sides of the cartridge. Some blasters run the hole in from the end, but I have always run the hole in the side. There is no reason for preferring the side-pick system other than this is how I was originally taught.

Insert the cap on the fuze snugly into the hole in the punched cartridge. I use a precut eight-inch length of baler twine to tie the capped fuze securely in place. Place the knot over the pick hole to protect it a bit.

This package constitutes the cap charge.

It is much easier to light fuze if it is sliced back about an inch, exposing the inner powder train. Otherwise, the tar coating may burn with a weak, yellow flame for a minute or two before the fuze itself sputters to life, giving the neophyte apoplexy in the process.

Electrical caps are inserted into cartridges much the same way fuzed caps are installed. In the case of electrical caps, the leads can be knotted around the cartridge to hold the cap in place without compromising safety.

Electrical caps are most practical when multiple charges are shot. It is possible to shoot a number of charges simultaneously using match cap and fuze with detonating cord, but if the charges are very far apart, the cost becomes prohibitive.

The first time I used det-cord was to take out a number of six- to ten-inch hawthorne trees. A covering of long, very sharp thorns virtually precluded cutting them with a saw.

I tightly wrapped three winds of det-cord around the trunks two feet above ground level, slipped a fuze cap between the trunk of the tree and the det cord, and shot them individually. In spite of a seemingly minimal amount of exposure, I pinched up my hands and arms doing even this much work around those damn trees.

Detonating cord looks like heavy, poly-plastic clothesline. It is fairly flexible, coming in ten-inch, one-thousand-foot reels. The explosive component of det-cord is extremely fast and powerful. It will take an eight-inch

green tree and splinter the trunk through to the core.

I had all the trees lying over in an hour.

The principal use of det-cord, other than placing it in ditches and holes the enemy might use during an ambush, is to connect multiple match and fuze charges together. The material runs forty cents per foot, precluding one from getting too carried away with this use.

To obtain more or less simultaneous detonations, you can wrap a turn of det-cord around each cartridge in a set running from the main charge that was capped conventionally to the side charges.

Match- and fuze-capped charges are fairly reliable in about ten feet of water. When going deeper or using electrical caps, I place the capped charge in a thin plastic bag. The water pressure will collapse the bag, which helps seal out harmful moisture.

Besides the combination tool and a pocket knife, the blaster will need a long-handled shovel. The wooden handle is good for poking the cartridges down the bore hole, especially the first charge (called the spring or springing charge), which is used to create the main powder chamber under the stump or rock.

I have marked my shovel handle with pieces of tape spaced every eight inches to quickly indicate how many charges can be placed in the hole. Some blasters use a separate tamping stick. I don't find this necessary.

When I was a young man, we often saw dynamite augers being sold at farm auctions. After a few years, they all disappeared—I suspect into the hands of antique collectors. To make do, we purchased some of the many one-and-one-half-inch-diameter wood augers that barn carpenters used. By welding a five-foot-long, three-eighths-inch steel rod to them, we had a reasonably good dynamite drill. Now even the large-diameter bore carpenter bits are tough to find. An auger with flights rather than a flat-spoon cutting edge is needed to pull the dirt out of the hole. New or used, these tools are virtually unfindable.

By whatever means, a good bore-hole auger

is invaluable when doing serious work with commercial explosives. The flights must be wide enough to pull out small stones, the cutting edge sharp enough to cut small roots, the handle long enough to reach under the designated object, and the turning handle long enough to torque the rig through common obstructions.

Powder monkeys shooting mostly electrical caps will also need an ohmmeter to read the resistance in the electrical sets, a minimum of 250 feet of drop wire and up to 500 feet for heavier charges, such as that used for blasting duck ponds or drainage ditches.

After learning to make blasts with cap and fuze that allow the user to retreat as far as his legs and discretion take him, the user will also learn how to make sets that merely whoomp and do not throw rock and debris all over the state. Having learned to contain the blast by using the correct type and amount of powder, the blaster can feel more confident regarding the use of the shorter 250-foot drop wires.

Drop lines should be heavily insulated 14-gauge wire. The ohmmeter can be a simple instrument purchased from Radio Shack.

I have never used a blasting machine. Instead, I relied on a lantern battery for single charges and truck batteries for multiples under five caps. I try to limit my electrical sets to five charges. Casual dynamite users will seldom be called on to make sets larger than could be handled by five caps.

Larger sets, in my opinion, defeat the safety argument in favor of electrical caps—i.e., when they are touched off, they either go or don't go. With match and fuze there is always a question until the moment of detonation. Sometimes detonation takes what seems like forever between lighting the fuze, the retreat, and the whoomp.

Electrical blasting is not a mysterious process. It does, however, require a knowledge of the most basic laws of electricity.

Electric current flowing through a conductor such as a wire is comparable to water moving through a pipe. Voltage is the pressure of the water (electricity). Rate of flow through the

wire is measured in amperes. In a pipe, it is gallons-per-minute.

The diameter of a wire influences the rate of flow of electricity much the same as the diameter of a pipe influences the rate of water flow. The cross section of either (or lack thereof) opposes the flow or creates resistance.

The three factors—voltage, current, and resistance—are related in a formula known as Ohm's Law. Ohm's Law is probably the most basic piece of electrical physics.

Every schoolboy learns the formula at one time or another:

$$\text{Pressure/Resistance} = \text{Rate of Flow}$$

or

$$\text{Volts/Ohms} = \text{Amperes}$$

These terms relate to the three elements of an electrical blasting circuit, including the electrical cap itself, the source of energy, and the drop wires that carry the electrical current.

The electrical blasting cap transforms electrical energy into heat, which starts an explosive force strong enough to detonate the main charge.

Like a filament in a light bulb, the electrical charge heats a bridge wire embedded in a flash compound. The flash compound detonates an intermediate charge in the cap that is actually the primer. This small but powerful charge has enough strength to detonate the dynamite cartridge.

It takes an extremely short time for the electricity to heat enough to flash the compound. This time can vary, depending on the amount of electrical energy going to the cap. To a point, increasing the current lessens the irregularities among caps.

A minimum current of 0.3 to 0.4 amp will fire a commercial electrical cap, but safety and consistency dictate that a charge of 0.6 to 0.8 amps be used. Cautious blasters usually figure on a minimum of 1.5 amps of direct current (batteries) and at least 3.0 amps of 60-cycle alternating current from a wall socket or a portable generator.

Power sources for a shot can be delivered by blasting machines, commercial power lines, motor-driven generators, and storage and dry-cell batteries.

Most blasting machines, including the old rack-bar-type push boxes used in the movies, are portable electric generators designed to have high voltages. Newer blasting machines are sometimes the condenser-discharge type. Some machines that are more than adequate for ten simultaneous shots can be carried in one hand. They are discharged by a quick twist of the wrist.

Because of the high cost, I have never purchased a blasting machine. When hooked up in series or used while the engine is running, standard 12-volt truck batteries will usually fire more charges than I have the energy to install in one set.

For safety's sake, every charge set in a day should be fired that day. Do not allow a charge to stand overnight or even leave the site for lunch or a break.

No blasting should be attempted with vehicle batteries that are not fully charged or that show signs of any deterioration or weakness. The engine should be on fast idle when the shot is made to ensure that enough amperage is available.

Three types of wire are used in the blasting circuits:

Leg wires are the thin, insulated wires that run from the cap itself. They range in length from six to fifty feet. It is important to know the resistance of these caps, including the leg wires, so that accurate calculations can be made regarding the adequacy of one's power supply.

Resistance of Copper Wire Electrical Blasting Caps

Length of Leg Wires (feet)	Average Resistance (ohms)
6	1.53
8	1.66
10	1.72

Length of Leg Wires (feet)	Average Resistance (ohms)
16	1.91
20	2.04
24	2.17
30	2.00
40	2.20
50	2.40

Resistance can be extrapolated from six to twenty feet and from twenty-four to fifty feet. At twenty feet, the wire size in caps jumps from 22 gauge to 20 gauge. The heavier wires are needed for lower resistances over longer distances.

Connecting wires are those insulated wires run through the shot region that may be torn up at detonation. They are usually 20 gauge, ultimately connecting to the drop wires from the caps.

Drop wires are those that connect the basic set to the power source. If at all possible, these wires should be 14-gauge copper.

One must know the resistance of connecting and drop wires to calculate how many caps can be fired from a given power source. Use the following chart, along with an ohmmeter.

Gauge	Ohms per 1,000 ft. of drop wire
4	0.248
6	0.395
8	0.628
10	0.999
12	1.59
14	2.52
16	4.02
18	6.38
20	10.15
22	16.14

There are three types of circuits commonly used: *single series*, *series in parallel*, and *parallel*. Many times, the nature of the shot will dictate the type of circuit that must be used.

If there were fifty electrical caps rather than the six shown, the blaster would com-

pute the circuit as follows:

$$50 \text{ electric caps with 20-ft. leg wires} = 50 \times 2.04 = 102.0 \text{ ohms}$$

$$\text{Resistance of 100-ft. No. 20 connecting wire} = 1.0 \text{ ohm}$$

$$\text{Resistance of 250-ft. No. 14 drop wire} = .5 \text{ ohm}$$

$$\text{Total Resistance of Circuit} = 103.5 \text{ ohms}$$

If the current were supplied by a 220-volt AC generator, the current supplied would be:

$$220 \text{ volts} / 103.5 \text{ ohms} = 2.12 \text{ amps}$$

This is not enough power supply to power the necessary 3.0 amps of alternating current per cap that is considered a safe standard. To be entirely safe, the blaster would have to cut the set down to fifty charges. These readings can be verified by using the ohmmeter.

For example, fifty caps have a resistance of 51.75 ohms.

$$220 \text{ volts} / 51.75 \text{ ohms} = 4.25 \text{ ohms}$$

A partial solution—if a larger set must be used, or if one is working with a smaller power source such as a vehicle battery—is to connect the caps in a parallel circuit.

The resistance in this case is only the resistance of each cap. Using a parallel circuit or a parallel-series circuit, a huge number of caps can be fired. Some sets containing more than one thousand caps are made using a variation of a parallel series.

Parallel Series Circuit Example

$$200\text{-ft. No. 20 connecting wire} = 1.0 \text{ ohm}$$

$$4 \text{ caps in parallel series} = 8.12 \text{ ohms}$$

$$250\text{-ft. No. 14 drop wire} = .5 \text{ ohm}$$

$$\text{Total} = 9.62 \text{ ohms}$$

$$12 \text{ volts} / 9.62 \text{ ohms} = 1.24 \text{ amps}$$

Note that, with direct current from a battery only, 1.5 amps is required to set off a single cap safely. In parallel, only the resistance of a single cap between the connecting wires is used in the computation. Very large sets are made by placing more caps in a series between the parallel lines, but the computation does not change.

Going back again to the five-shot series (which for me is the most common multiple shot), we have:

$$100\text{-ft. 20-gauge connecting wire} = 1.0 \text{ ohm}$$

$$250\text{-ft. 14-gauge drop wire} = .5 \text{ ohm}$$

$$5 \text{ caps with 8-ft. leg wires} = 8.3 \text{ ohms}$$

$$12\text{-volt truck battery} / 10.4 \text{ ohms total resistance} = 1.15 \text{ amps}$$

Again, this is not enough direct current to meet the 1.5 amps of direct current criterion. However, with the engine running, I have found that the setup always fires properly. The following example, while not perfect, illustrates a relatively easy method of using common equipment to do some blasting.

Parallel-Series Circuit Example:

$$\text{Resistance of each series of 4 caps} = 4.0 \times 2.04 = 8.16 \text{ ohms}$$

$$\text{Resistance of 10 series in parallel} = 8.16 / 10 = .81 \text{ ohm}$$

$$\text{Resistance of 200-ft. connecting wire} = 1.00 \text{ ohm}$$

$$\text{Resistance of 250-ft. No. 14 drop wire} = .50 \text{ ohm}$$

$$\text{Total} = 2.31 \text{ ohms}$$

Assuming one used a 12-volt battery, the computation would be as follows:

$$12 / 2.31 = 5.19 \text{ amps}$$

Each series would receive $5.19 / 10 = .52$ amp, which is not enough to take us up to the 1.5-amp safe level required. The 5.19 amps must be divided by 10 because there are ten series of four in the string.

Using a portable generator:

$$220 / 2.31 = 95.6 / 10 = 9.56 \text{ amps}$$

A portable power generator would probably be adequate in most situations, but vehicle

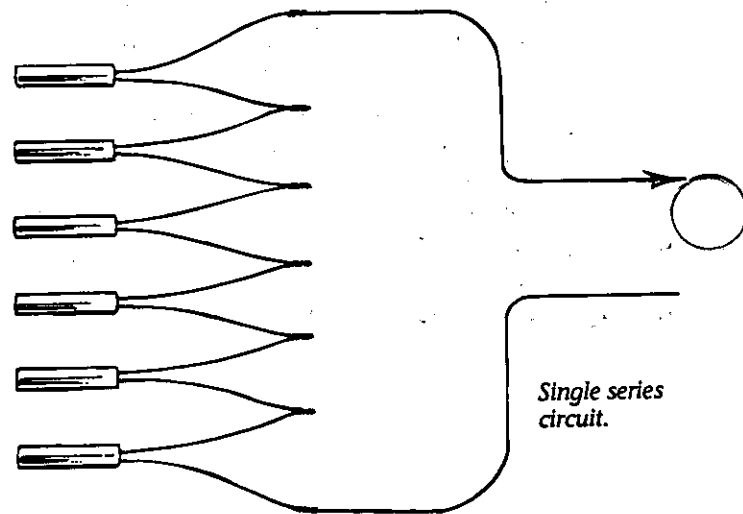

batteries, even wired in series, would not be. The only exception might be to power the charge from a large bulldozer battery while the machine is running and the battery charging. Test all multiple shots with an ohmmeter, and use short leg wires and heavy drop wires to minimize wire-resistance problems.

In the cases above, the examples are very conservative. They probably do not reflect the average day-to-day needs of the home and recreational blaster. As I mentioned previously, I have always powered my little four- and five-cap sets with a 12-volt car battery or even a 6-volt lantern battery. Remember, the rule of thumb is 1.5 amps per cap for DC and 3.0

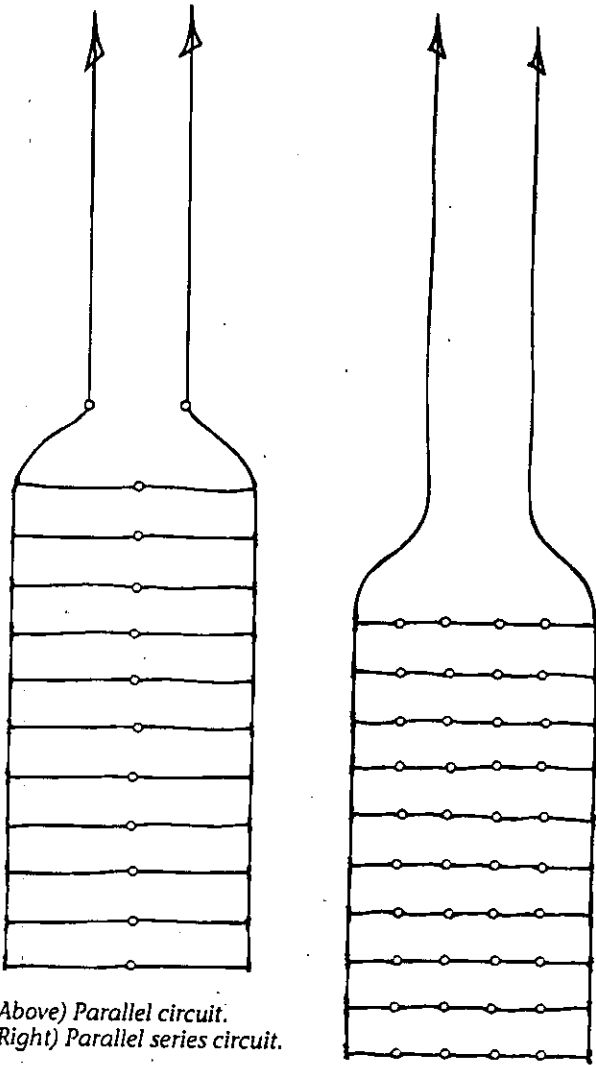

(Above) Parallel circuit.
(Right) Parallel series circuit.

amps for AC.

Electrical splices on blasting lines are critical. Most experienced blasters prefer the twisted-loop splice. This and an equally acceptable telegrapher's splice are illustrated below. Your ohmmeter will quickly tell you if all the splices are sound, making good electrical contact.

Be sure to keep all splices tight and practice



Twisted-loop splice.



good housekeeping with the connecting wires. Neat, taut runs are likely to cause fewer problems. All open-wire splices should be raised up off the ground, away from puddles or wet grass, using dry rocks or pieces of cardboard as props.

Again, be sure to test each circuit with an ohmmeter to be certain the power source you intend to use is adequate. All drop and connecting lines should be wound (shunted) together securely until they are connected. Connecting should be the last step as the user retreats from the blast site. Keep the drop wires shunted and the power source well out of any possible reach until the moment you are ready for the shot.

For God's sake, *cease all operations* if an electrical storm comes up. Even miners working a mile underground do something else till an electrical storm has passed over.

One thing to keep in mind is that not all charges go off according to the user's prearranged plan, as evidenced by the following tale.

I was waiting in front of the low, white, wooden, houselike structure that serves as the consulate in Chiang Mai, Thailand. Suddenly a wind-shock thump, strong enough to take out exposed windows, hit me. A long, low rumble followed, echoing up the Ping River, which runs near the consulate. I ran out the gate and onto the street, where I could see to the north a kilometer or two. It was possible to make out a black, swirling cloud of dust over the trees and houses.

The detonation was deep and gutsy enough to get our serious attention but distant enough not to cause real alarm. My first reaction was to look for aircraft.

It took what seemed like an inordinate amount of time before some sirens began to wail in the distance. We jumped into a friend's Land Cruiser and headed out for a look. Obviously, something was going on that we should know about.

A line of police and military vehicles, many with flashing lights, was converging on one of the rather nondescript yet more exclusive neighborhoods of north Chiang Mai.

We followed discreetly until we started to

get walled in by hundreds of people walking down the street. Without an escort or a flashing light, we could not proceed. I asked a police officer what was going on. He just shrugged. Either he didn't know or he wasn't going to tell a *farang* (foreign devil).

By now an hour had passed since the blast, but still no one on the street knew what had happened except that there had been an explosion. Just before dark, we finally threaded our way through the little narrow streets to the remains of a palatial home.

Leaves on the palms in the garden hung in tatters, shredded into threads. Several buildings nearby lacked roofs. A school half a block away was windowless on the blast side. A harried police officer told us no children were at the school when the blast hit.

Dozens of uniformed men poked around in the piles of debris. The front of the massive house hung in tatters. One wall of a former garage leaned sloppily amidst the mess. There might have been other damage, but a twelve-foot cement block wall around the property limited our ability to see everything that was in the compound.

"Looks to me like a commercial dynamite blast," I told the consular official. "The trees and bushes aren't blown away enough for it to have been a faster, much more powerful military-type explosive." No one seemed to know whose house had been hit or if anyone had been injured. Gossip spread through the crowd to the effect that no one had been home at the time of the blast.

After a day or two, some information filtered out about the incident. The house, we learned, was the secret retreat of General Li, a notorious Kuomintang Chinese drug lord. General Li, who originally came from northern China to Thailand at the time of Mao, was so reclusive that no one was aware he lived—at least part-time—in Chiang Mai.

It was not entirely true that nobody was home when the blast occurred. A bathtub sal-

vaged from the carnage became the repository used by the police. It was filled with body pieces they collected. A cook and driver were never seen again, but were never identified among the pieces, either.

The theory on the streets was that some of General Li's drug-dealing enemies had tried to assassinate him, but that their timing was bad. A truck that allegedly had contained the explosives had been vaporized in the blast. The police didn't even try to find a bathtub full of parts from it.

My theory is somewhat different. It seemed obvious that we were dealing with a relatively large quantity of commercial dynamite rather than military explosives. I knew that people in the Chiang Mai region often illegally traded commercial explosives for raw opium with the jade miners who used the explosives to get rocks out of the ground. I reasoned that perhaps we were dealing with an accidental detonation. Assassins almost certainly would have used military explosives.

The theory is reinforced by the fact that one of General Li's drivers appears to have been wiped out in the incident, that Thais are awfully cavalier about explosives, and that an assassination attempt was not logical. No one in the region had an overt motive for doing the general in. If they had, it seems logical that they would have planned the whole thing a bit better.

My accidental discharge theory apparently has gained some credibility, because many Burmese jade smugglers have come forward in the last year since the incident to complain that their source of explosives has dried up. More significantly, no one among the drug lords has come forward admitting to perpetrating the incident. If it had been intentional, General Li would have retaliated. Open warfare did not break out among the drug lords.

Knowing the Thais, they probably stored the caps with the powder. Later, when they snuck off in the truck to have a smoke, disaster struck.

CHAPTER 19

DOING THE WORK

Novices who work with dynamite for the first time are often surprised to discover that commercial explosives are very precise in nature. They expect to encounter an uncontrollable, unpredictable force that promiscuously rends the Earth. Instead, they find they are working with a tool that can be likened to a hugely powerful precision instrument.

One of my earlier jobs as a powder handler involved placing charges for a neighbor who wanted to excavate the ground under his standing home. The guy was determined to have a basement under his house—despite the fact that the original builders one hundred years ago had not seen it that way at all! We had a small four-foot by four-foot root cellar to start with. As a plus, the stairs going down were already in place. Lack of moisture for one hundred years, however, had set up the soil under the house like concrete—digging could not be accomplished via traditional pick and shovel methods because of limited space and the hardness of the earth.

Using mud and wet burlap bags to cap the charges, we shot half sticks of 60-percent dynamite to break up the existing pavement and walls in the root cellar. The cement was not particularly thick but had been placed back when it was de rigueur to do a very good job. The breakup would have been impossible if it weren't for the larger rock they mixed with the concrete in an attempt to save on material costs.

After the concrete was cleared out, I used a 1 1/2-inch hammer driven mason's hand drill to bore a hole back into the century-old hardened clay. The material was so consolidated and brittle that a half stick of 60-percent shattered a cone-shaped hole to dust.

I carefully worked the charges back to the area below the house's rear support beam. We shoveled the now loose material into a conveyor belt that moved it upstairs and deposited it in a dump truck parked at the rear of the house. By nightfall, we had excavated an area large enough to build a frame for a foundation wall.

I let the owners spend the next day completing that work, as well as shoveling out the remaining loose material I had shaken loose.

While the new cement was hardening, I worked back in the other direction with my explosives. By week's end, the back wall was in place as well. Although I fired possibly twenty-five shots, nothing in the house above was damaged. The lady of the house said she was surprised that the blasting produced very little dust and no damage. We usually warned her before the shots, but otherwise the work failed to disturb her routine.

Precision blasters have shot holes in solid rock within inches of high-pressure gas lines. They have opened trenches so that telephone lines could be laid right through the heart of large cities and have spectacularly demolished great buildings that stood within inches of other great buildings that were not even scratched.

Although it is the wrong end of the spectrum on which a novice should start, propagation sets used to cut ditches illustrate the precise nature of dynamite nicely.

Because a field drainage ditch is seldom if ever blasted through regions where one must be concerned about coming too close to buildings, gas mains, power lines, or other works of man, blasting one is a good project for someone who wants to test the precision of explosives. The technique is not, however, one the novice should start with if he has any choice in the matter. It is so difficult to master ditching with powder that the neophyte can become discouraged easily.

Ditch building by propagation is done using regular ditching powder. Your local explosives dealer can assist you in choosing the correct explosive material. This will be either a 60- or 80-percent material that is more sensitive to shock than regular powder and is of itself powerful enough to throw out a large quantity of material. Other powder may push rather than shock and throw, and will certainly not be sensitive enough to propagate. The concept is to use one cap charge to set off up to hundreds of shock-sensitive cartridges, all placed in a predetermined grid.

Unlike 40-percent dynamite, which is so sleepy it often cannot be detonated even by a direct hit from a high-power rifle, ditching powder is very shock-sensitive.

When I first used it, I carried the cartridges around in a sawdust-filled box. This seemed to be more paranoia than I am accustomed to accommodating, so I decided to experiment.

A half-pound stick thrown as high as possible from the top of a twenty-four-foot barn did not detonate on hitting the frozen clay drive below. Eight additional attempts failed to produce a bang. I therefore concluded that the material was safe enough under normal circumstances.

It does, however, go off rather resolutely when hit with a bullet. Through the years, I have spent a considerable number of pleasurable hours on my range plunking off dynamite. There is never a question as to the place-

ment of the shot. If it is good, everybody in the county will know.

Shooting dynamite is a bit tougher than it first seems. Targets little more than an inch wide are tough to hit, especially if one places them out far enough so that the blast does not constitute a danger to the shooter.

One time when such things were still permitted, I bought a 25mm French Peteau cannon home with me. It came right from the World War II Maginot line—eight hundred pounds, rubber tires, etc. By tinkering with the firing mechanism, I was able to bring the monster back to life. We spent many an enjoyable afternoon firing that cannon. Factory ammo costs about \$32 per case of thirty-two rounds!

Eventually the thrill wore off. We went back to using ditching powder for targets, set off by more conventional firearms, but the neighbors never knew the difference. They thought we fired that antitank cannon one hell of a lot.

The best way to proceed with ditching powder is to run a couple of trial sets. In places where the ground is consistently wet, grassy, and marshy, the charges can be placed up to two feet apart. Should one be working with ground that is only very damp and not wet, the spacing may only be four to eight inches. Old logs, rocks, and roots mixed in the material to be ditched may require that one cut the distance between charges down even further.

It is impossible to tell what spacing to use, even by looking, much less make a valid recommendation in a book. The only way to find out what will work is to try an experimental shot.

Only one cap charge is used to set off all the charges. Be careful to note whether the shot detonates all the charges placed in the string. Some borderline cartridges may be thrown out undetonated. No matter how ideal the conditions, the maximum spacing will never be more than two feet. Generally you will end up setting up the shot grid on about one-foot centers unless the ground is virtually saturated with standing water.

Before starting in earnest, run a cord and post line down through the region you want ditched. Unlikely as it seems, running a

straight line of cartridges without a physical line staked out is incredibly difficult. A nice, straight ditch that the powder monkey can be proud of will result if such early precautions are taken.

Experimental shots are done not only to determine at what spacing the shot will propagate, but also to determine how much powder is needed to produce a ditch of the necessary depth and width. Obviously the depth at which the charges are placed is extremely critical if proper drainage is to result. As a general rule, a charge set three feet deep will cut down to about four feet if enough powder is placed above to move away the overburden material.

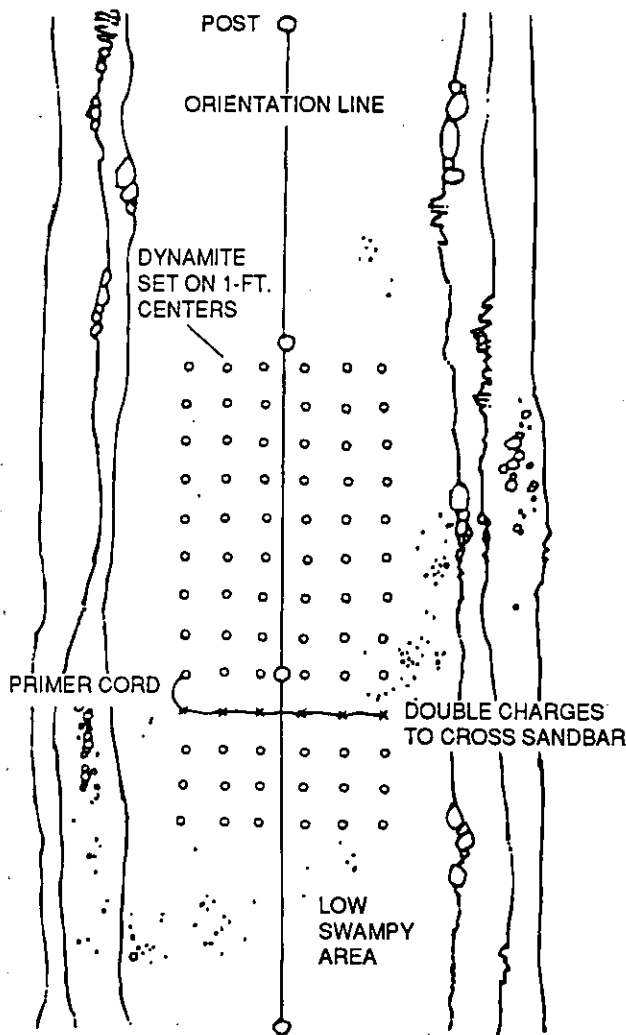

Top view of a ditching grid.

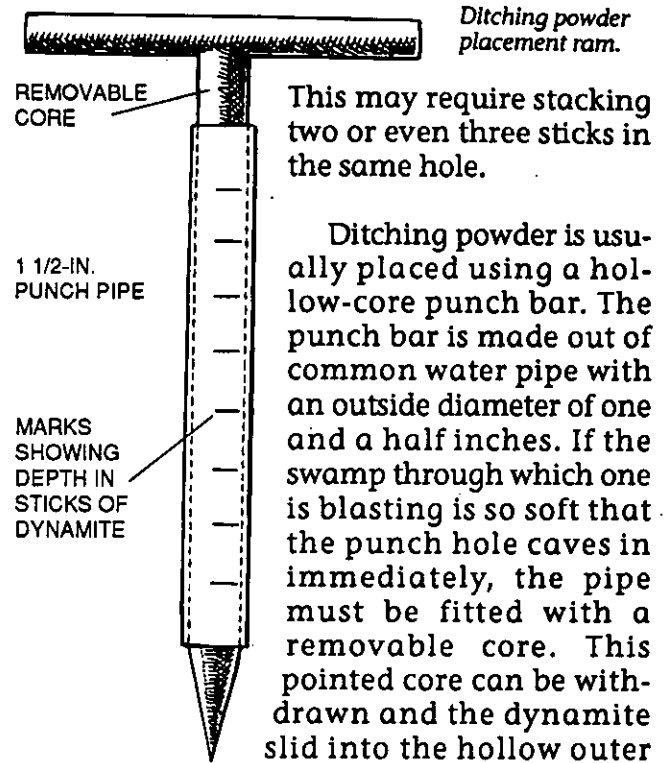

This may require stacking two or even three sticks in the same hole.

Ditching powder is usually placed using a hollow-core punch bar. The punch bar is made out of common water pipe with an outside diameter of one and a half inches. If the swamp through which one is blasting is so soft that the punch hole caves in immediately, the pipe must be fitted with a removable core. This pointed core can be withdrawn and the dynamite slid into the hollow outer

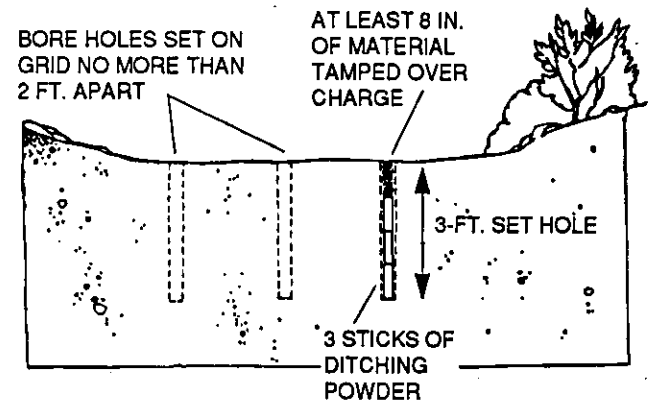

Side view of ditching set.

shell and held in place with a wooden tamping stick as the punch is withdrawn.

It is helpful to fit the punch with a handle to facilitate pulling, and it is essential that deep, easily seen notches be ground in the probe's outer shell showing the depth of the tool in dynamite cartridge lengths.

Every cartridge must be identically placed through material that is identical in makeup.

Sandbars or subsurface logjams through which the dynamite will not propagate can be

handled by placing the charges in their regular predetermined grid and firing them with primer cord or by electric detonation. Determining exactly how much powder to use in this circumstance is a bitch. Because the ground is not wet and lubricated, it would seem as though it would take less explosives. This, however, is not necessarily true. As no set rule exists that I know of, the best thing to do is to make sure to use plenty of powder. It is always tough to go back and hit the area again.

If there is doubt and experiments are not practical, use at least twice the amount that you originally estimated would do the job when crossing a dry bar or other obstruction.

In all cases, mark out the ditch with posts and a string with a great deal of precision. Use small wire flags to indicate the location of the charges if there is danger of them being lost or misplaced in the marsh as you work around your grid line. The grid of charges must be very accurately placed according to a pretested, predetermined plan.

When a ditch set is detonated, there is a very nice ground-shuddering thump. When enough powder is used and the grid is correct, the work accomplished is very gratifying as well as being most spectacular. The material from the ditch is thrown out and away without forming a costly-to-handle spoil bank. Spoil banks would be there if the ditch were dug mechanically. Often the dirt and water are thrown two hundred feet into the air, negating any need to bring in a dozer with a blade to smooth things over.

Other advantages to cutting ditches with explosives include the fact that men and horses can pack explosives into places otherwise inaccessible to backhoes and power shovels. Much smaller jobs can be undertaken profitably due to economies of scale. Mechanical equipment requires a much larger job to be profitable. Using explosives is also often much faster than hauling in power shovels.

At the time the charges are placed, it may seem as though costs are going through the ceiling. But in most cases, when everything is

added in, expenses are far less than when using other means.

Clearing grass and other material out of an existing but silted-in ditch is virtually always faster and easier with explosives. In this case, a single string of cartridges is run down through the existing ditch line. If the cartridges are buried at least three inches beneath the surface, as they should be with any propagation set, clay and plastic field tiles emptying into the ditch will not usually be harmed.

There is no limit to the number of charges that can be fired using one capped charge as the explosive impulse through the moist soil. Using three helpers, I have set almost a ton of dynamite in one day. The only practical limit is the amount of territory available on which to work and the amount of energy and drive one can muster to put out the explosives.

All charges placed in a day should be fired that evening. Ditching powder is not particularly water-sensitive, but many other factors could lead to a potential misfire or an unsafe adventure if the charges are left unfired overnight.

Field conditions, vis-a-vis the season of the year, are important whenever one uses explosives. When blasting ditches, wet ground condition is one of the primary considerations. It may be necessary to either wait for a hot spell to dry up the ground or, conversely, for spring rains to bring enough moisture to allow the system to work. Only shooting a trial charge will provide the necessary information.

Clearing out stumps comprises the other end of the spectrum of work with which a powder handler will probably involve himself. Stump removal is not only common, it is reasonably easy to master. Most blasters will do as I did and learn the ropes of the business in the field actually doing the work.

Stumping is both easy and yet quite a challenge for those given to thinking about such things. Like cutting a diamond, every situation is a little different. Some varieties of trees (such as Norway pine, hickory, white oak, elm, and gum) have massive, deep penetrating roots referred to as tap roots. Others (such as white pine, fir, maple, box elder, and cedar)

have heavy lateral root structures. There is no tap root in this second case, but rather large branch roots extruding out to the side in all directions. Removing these stumps can be a real problem. If they are not charged correctly, the dirt will be blown away from the base of the stump, leaving a wooden, spider-like critter standing in the field that is very difficult to cut away.

Unless one is a trained forester, it is impossible to tell for sure what kind of a stump one is dealing with a couple of years after the tree has been cut. The most certain plan is to use the dynamite auger to bore a hole under the stump and do a bit of exploring.

If the auger hits a tap root on a 30° angle down under the stump, it's safe to assume it's the kind with big, vertical roots. Sometimes, however, that pronouncement is premature. Hit it once with a springing charge, which will throw away the dirt and soil around the root. If the stump has a tap root, it will then be obvious.

I do not like to try to bore a shot hole into the tap roots to save powder. What I save in powder breaking the root off underground, I lose in Wheaties trying to force the auger into the punky, tough-as-wang-leather wood.

Instead, clean out a space next to the tap root about the size of a small pumpkin. Pack in eight to ten—or more if the stump is still large and green—40-percent cartridges against the tap root and let 'em rip.

Stumps with massive lateral roots require about the same procedure. Dig the auger in under the main stump mass, fire a single holding charge, and then hit it with the main charge. The essential element is knowing how many cartridges should comprise the main charge. Conditions change from day to day

Size of stump 1 ft. above ground	Condition of stump	Number of cartridges	Soil type	Add number of cartridges	Add for tap roots
6"	Green	2	Wet	0	0
	Dead	1	Sand	+2	0
				Clay	+11
12"	Green	4	Wet	+1	0
	Dead	2	Sand	+3	0
				Clay	+1
18"	Green	7	Wet	+2	+1
	Dead	3	Sand	+4	+1
				Clay	+2
24"	Green	9	Wet	+2	+2
	Dead	5	Sand	+3	+2
				Clay	+3
30"	Green	12	Wet	+3	+3
	Dead	6	Sand	+4	+3
				Clay	+5
36"	Green	15	Wet	+4	+4
	Dead	8	Sand	+4	+4
				Clay	+4

and from soil type to soil type. Try using the following guidelines for starters:

Do not, under any circumstances, allow your mind to go into neutral while stumping with dynamite. The result can be a bunch of thundering roars that throw pieces all around or, even worse, a blast that simply splits the stump while leaving it firmly anchored in bent, broken sections in the ground.

Blasting stumps quickly teaches novice

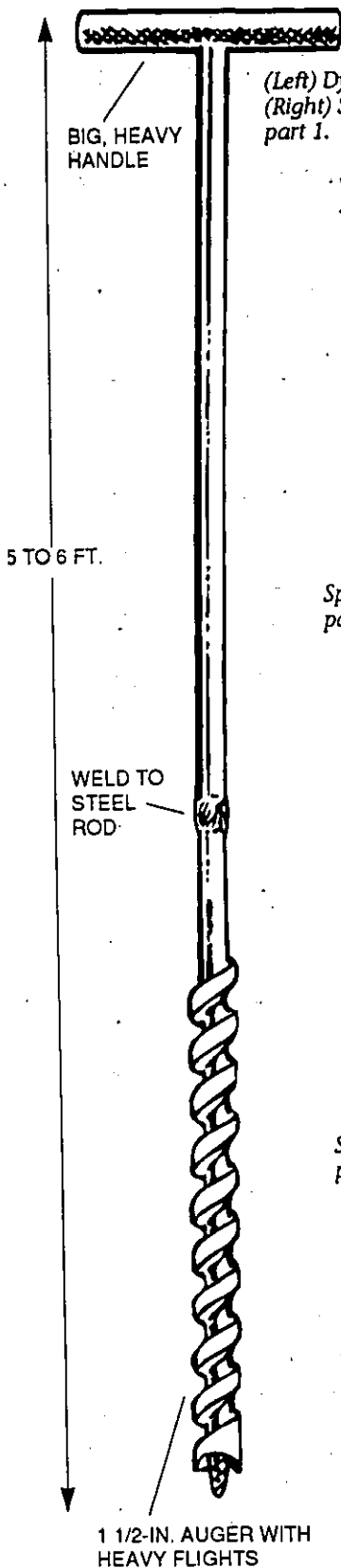

(Left) Dynamite auger.
(Right) Sprung hole charge, part 1.

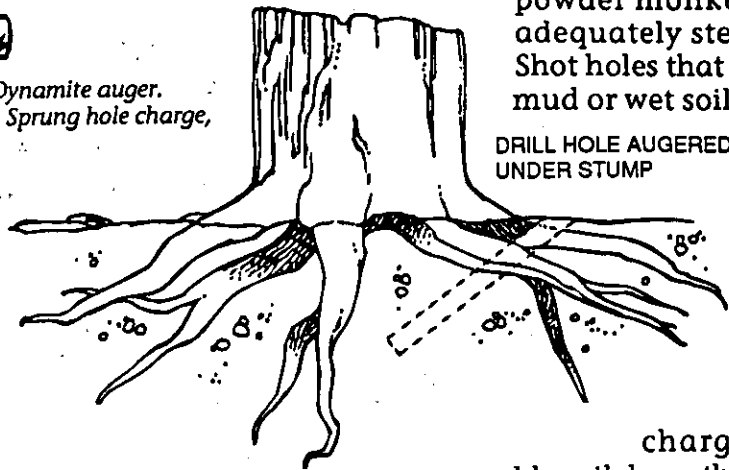

powder monkeys the importance of adequately stemming their charges. Shot holes that are solidly packed with mud or wet soil contain the explosion in a much more satisfactory manner than if this chore is neglected. The difference can add up to a case or more of powder by the end of the day.

Start tamping the charge by dumping some crumbly soil down the shot hole on top of the cartridges after they are in place. Do this with the wooden handle of your tamping stock or shovel. Keep working the hole until it is plugged up with tightly tamped soil. It also helps immeasurably to pile a few shovels of dirt on the hole after it has been filled to ground level.

Sprung hole charge, part 2.

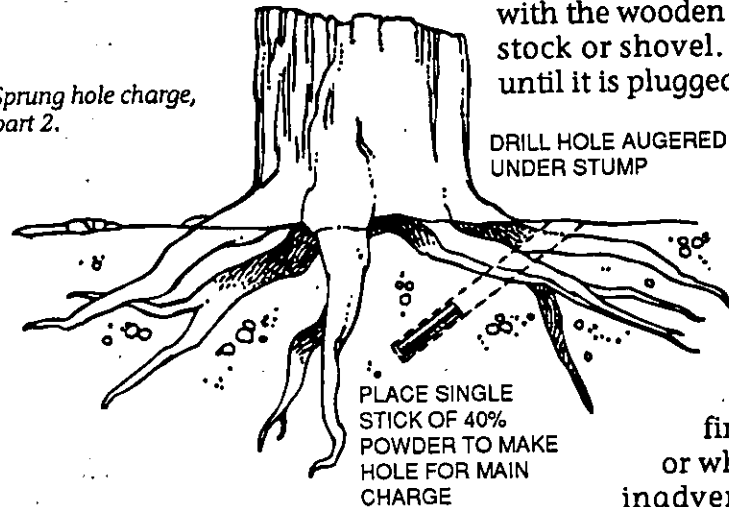

At times when the ground does not adequately contain the first springing shot charge or when the powder monkey inadvertently overcharges the set, the blaster will find that he must move in quite a bit of material with which to

Sprung hole charge, part 3.

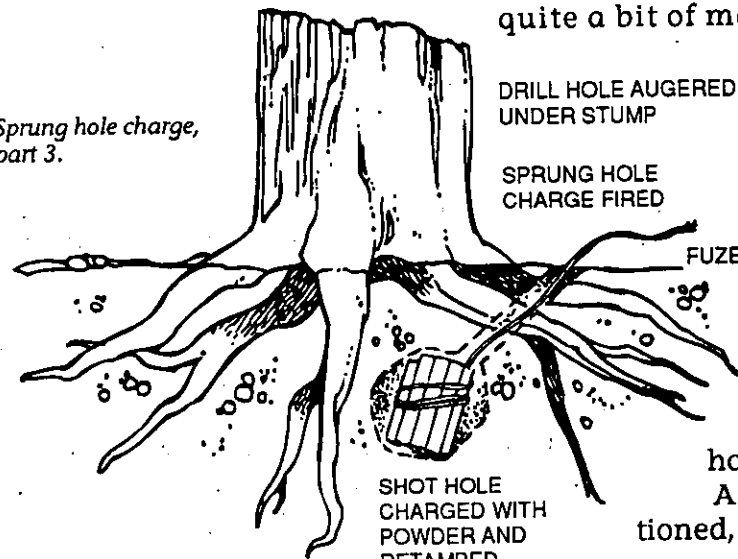

tamp the hole under the stump. Best to fire up the long-handled shovel and move in whatever it takes to do the job properly. Usually, if this happens, the surrounding soil will be loose and easily shoveled as a result of being torn up by the sprung hole charge.

As previously mentioned, some people who work

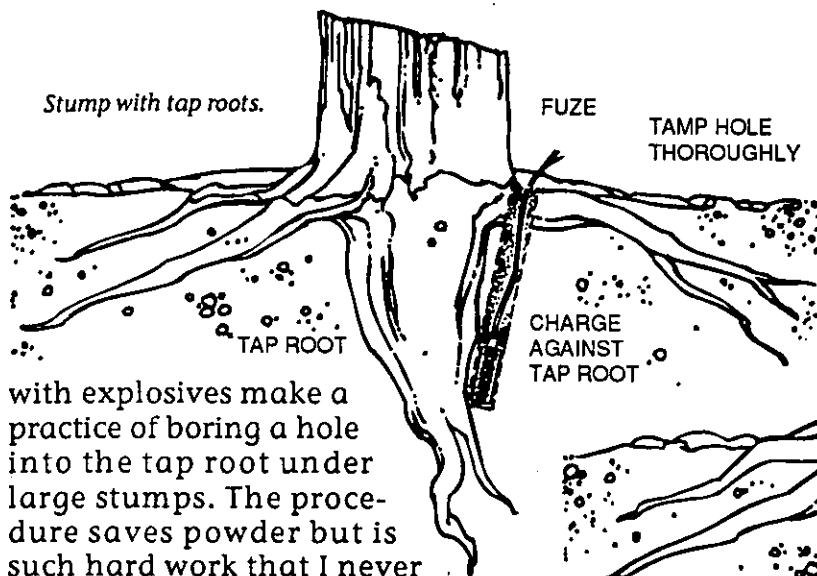

with explosives make a practice of boring a hole into the tap root under large stumps. The procedure saves powder but is such hard work that I never became enamored with the concept. In the case of a very large stump with corresponding tap root, I will either pack the tap root on one side with an unusually heavy charge or split the charge into equal parts and fire the two simultaneously with electric caps or primer cord.

Some stumps with many lateral roots can simply be chopped off at ground level using faster powder. Pick a fold in the stump into which several sticks can be packed. Cap them over with a heavy layer of mud and fire them off. If done properly, the stump will be rent into little pieces, leaving the bigger subsurface roots at ground level to rot.

The most difficult stump to take out is one that is burnt or has been already shot, with only the heart taken out. The various sections must either be shot electrically with two or more charges or, in some cases, the shell can be wrapped with a chain and successfully shot out in one piece (see illustration). It still may be necessary to use multiple charges but the chain will tend to hold the stump together and pull it all out in one piece. Use plenty of chain along with slower 40-percent powder or less when employing this method.

Removing stumps with explosives works specially well if one can combine the work with the efforts of a bulldozer as mentioned

earlier. The dozer can be rigged to punch the charge holes. It can grub out those stumps that are not sufficiently loosened by the dynamite and it can fill in excessive holes made by using too much powder. It's an ideal combination if the novice powder

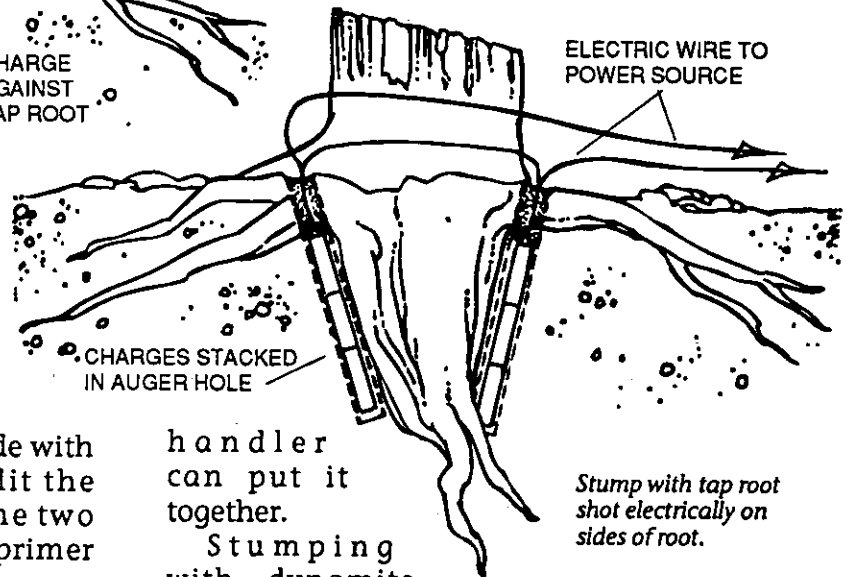

handler can put it together.

Stumping with dynamite was, in the past, the most common nonprofessional use for explosives. Stump removal is no longer a big item with farmers, most of whom are currently working fields that have been cleared for more years than the farmers are old. I don't know which use is currently in second place, but for us it was removing and breaking stones, old foundation footings, and cement pads.

Huge stones, many as large as cars or pickups, can be thrown free of the ground, mud-capped, split, and hauled away using a few sticks of easily portable powder by one skilled powder monkey.

One monster stone on our farm had maliciously and mercilessly torn shares from our plow for years. It lay about one foot below ground level and was flat as a dining room table and just as big if one added all the extra leaves. One day it ate two of my shares simultaneously. That was absolutely it. I went straight back to the shop for the dynamite. My brothers depreciated my determination.

Chaining split stump for removal in one piece.

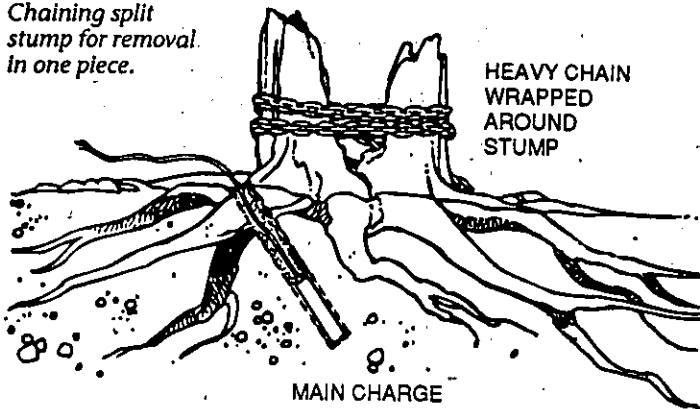

Split charge fired with det cord to take out stump left in two pieces.

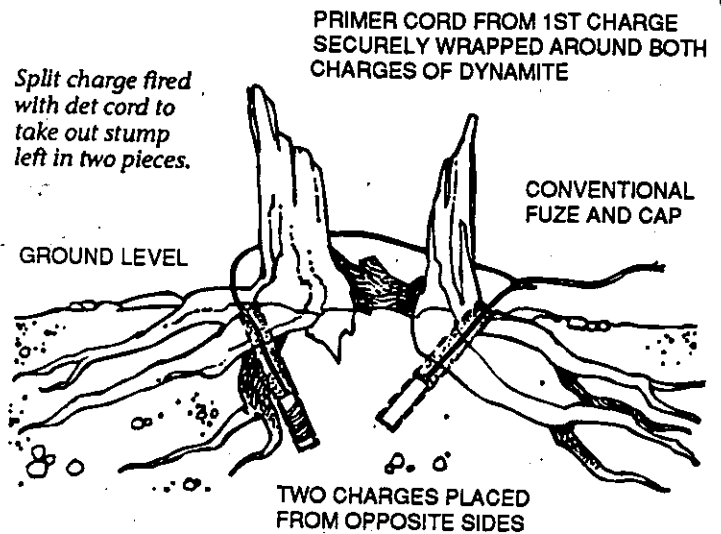

"That stone is so big and mean," they said, "you don't have enough powder to get it out."

How words are sometimes so prophetic. It was not immediately obvious what I was working with. A five-foot auger did not reach to the bottom side of the rock. One stick fired as a springing charge did very little. I dropped in a bundle of seven and threw out a nice hole that I could get down into with my shovel. Again using the auger, I went down under the monstrous piece of granite. Another charge finally poked an adequate cavern under the rock.

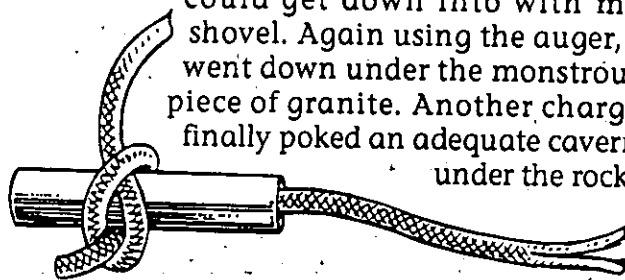

Det cord attached to conventional fuze and cap used to detonate the det

SPLIT FUZE TO FACILITATE LIGHTING

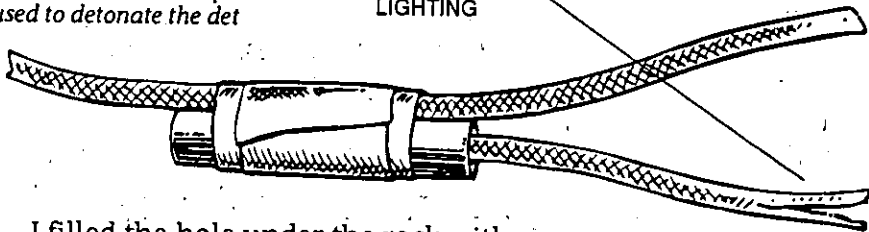

ing a gaping hole that eventually filled with water and mired our tractors every year we worked the field till we sold out. It had to be the biggest rock anyone in the county had ever tried to contend with in one piece. Two of our biggest tractors could barely pull it away.

Even normal, garden-sized rocks are best handled by a variation of the technique we used. Get a springing charge hole under them and throw them clear with lots of 40-percent powder. The technique requires quite a lot of digging and augering, but it's the only way I know of for one man to remove boulders economically.

Rock outcroppings can be removed nicely with dynamite. The technique is similar to breaking up large rocks for transport.

I filled the hole under the rock with approximately thirty sticks of 40-percent powder. Not many rocks require that much powder, but this was not an average rock. By now I was so pissed off, I would have used three hundred if that's what it took. My brothers wanted to split it in place but, in my eyes, that would have been a cop-out.

The thirty sticks thumped about hard enough to be felt in the county seat fifteen miles away. El Rocko pitched out on the ground, leav-

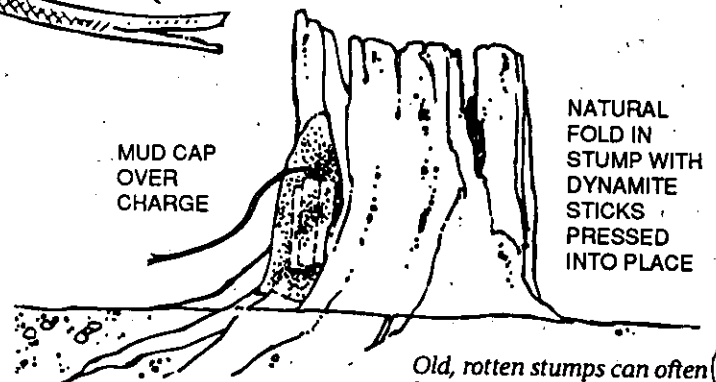

Old, rotten stumps can often be blown off at ground level with a mud-cap charge.

Building and Keeping Your Arsenal Secure

Large boulders such as the plow-eating monster are usually mud-capped and split into hundreds of easily handled pieces. It's better to haul them away whole, if you have big enough machinery, rather than pick up all the pieces. But in cases of very large boulders, that is often not possible.

Mud-capping consists of placing a number of sticks of fast 60- or 80-percent powder on top of the victim rock.

Cover the cartridges with four to six inches of very wet mud and

Crawler with punch lowered and pushed under stump.

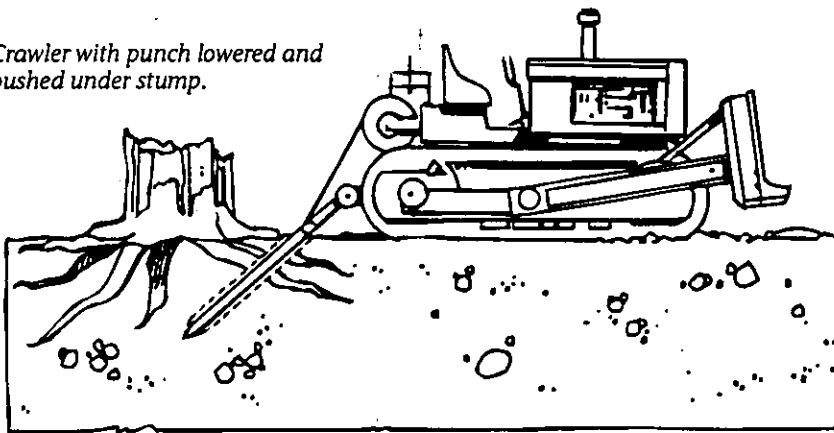

touch it off. Apparently, shock waves from the sharp, fast detonation fracture the rock. It is the one case when a powder handler can experience a nice, audible explosion as a result of his labors. The mud vaporizes. There is no throw-rock danger from mud-cap charges.

At times, powder handlers will use a large masonry drill to bore a hole into an offending rock. After filling the hole with powder, they shoot it much the same way a miner would shoot a working face.

Driving a steel drill into a solid rock is a poor substitute for conventional, easy-to-set-up, effective mud caps, but it is necessary if one wants to take out a rock ledge or outcrop.

Home builders sometimes find underground ledges through which they must cut for footings or which are otherwise in the way. When the job is too small or too remote

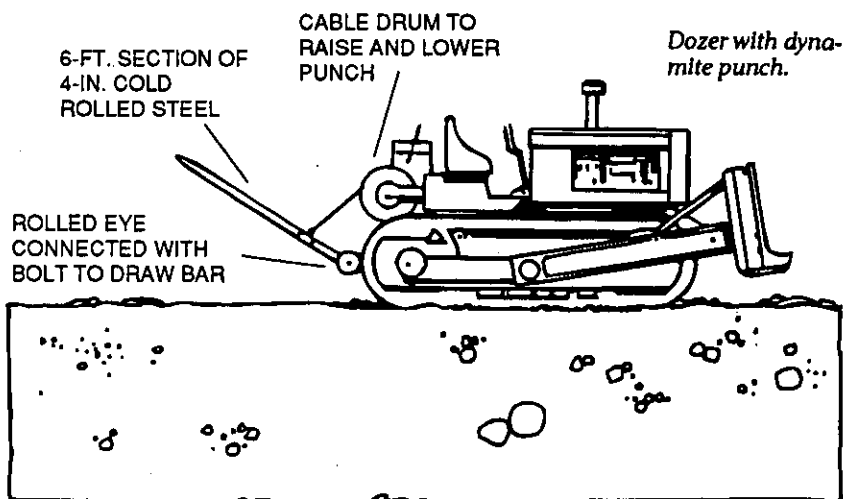

to bring in a ripper, there is no alternative to trotting out the rock drill, hammers, and powder. Use fast powder if it is easier to clean up with a scoop shovel and wheelbarrow. Slow powder creates bigger chunks that are best pulled away with a tractor.

Old footings and cement pads can be broken into large chunks by placing fast 60-percent charges a foot or so under the material. The shock will tip up

the slab or footing as well as breaking it at the point of impact. If the cement contains reinforcing metal, it must be further cut mechanically. Metal is usually too tough and flexible to be cut with explosives except in special military situations.

Road building through hilly terrain is nicely done with explosives. Start by boring down into the ground between the rocks with your auger. Place as much explosive in the hole as possible. This will loosen the rock and soil so that it can be moved. Keep working down in and around whatever obstacles exist until the roadbed is about as wide and deep as needed. Even a farmer with a small tractor can cut a road through a rocky hill using this method along with a relatively small amount of explosives.

Several other chores that are a bit obscure are possible with dynamite.

Springs that are leaking water onto one's

Removing a deeply buried boulder.

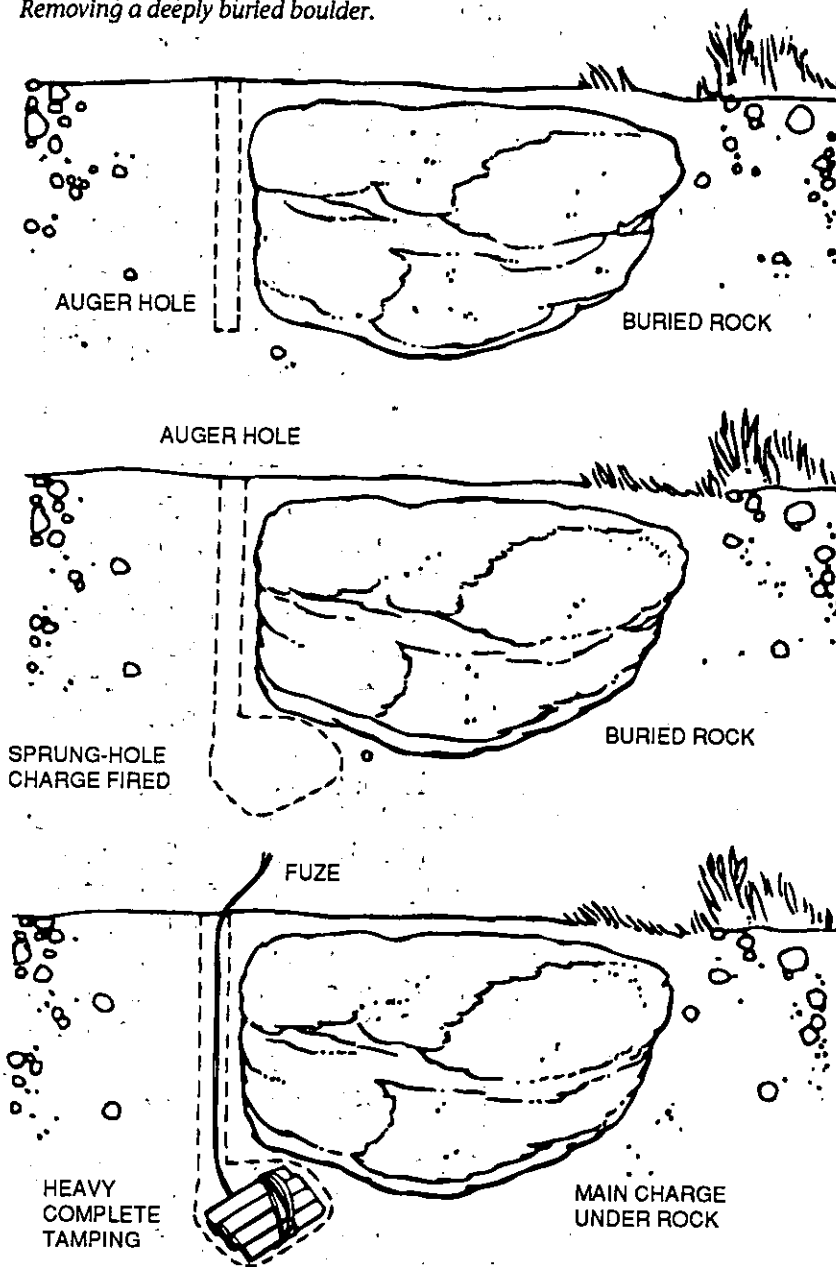

property and creating bog holes can sometimes be shut off permanently by shooting a large charge of fast powder deep in the ground above the hill where the water surfaces. Not every attempt is successful but, given the modest cost, it is worth a try.

Small potholes are often drained by shooting a charge of fast, shocking-type powder deep in the underlying hardpan that forms a water barrier for the hole. This must be done at

a time when the hole is dry and the hardpan barrier becomes brittle.

In both cases, bore down with a post-hole digger and set the charge at the very bottom of the hole. Tamp the set shut nicely. In the case of the pothole, it may be spring before it is obvious whether the shot was successful in breaking the clay barrier.

Other work—such as blasting out duck ponds, tunneling through rock, or cutting down a rock hill for a road—can be done with a combination of dynamite and ammonium nitrate.

Building a tunnel is not usually work that the casual home and recreational user will do. This generally is left for the miners who do that work. Like stumping, tunneling through rock is best learned by trial and error. The trial involves finding a seam soft enough into which you can sink a hammer-driven star drill. With a bit of practice, it is possible to determine what drill grid will allow the powder to do its best work. Usually it is advisable to fire the outer charges first, releasing the wall so that the inner charge can dislodge the most rock. Hardened rock drills can be purchased from specialty hardware stores.

Another common category of working uses for dynamite is taking out ice.

The farm on which I grew up was surrounded on three sides by a fairly large river. Our most productive riverbottom field was once threatened by a huge ice jam causing floodwater to cut across the field. Our neighbor on the other side of the water watched jubilantly as Mother Nature prepared to hand him an additional forty acres of prime farm ground. (Land titles at that time specified that ownership ran up to the high water mark of the river, wherever that might be.)

Building and Keeping Your Arsenal Secure

Using a mud-cap charge.

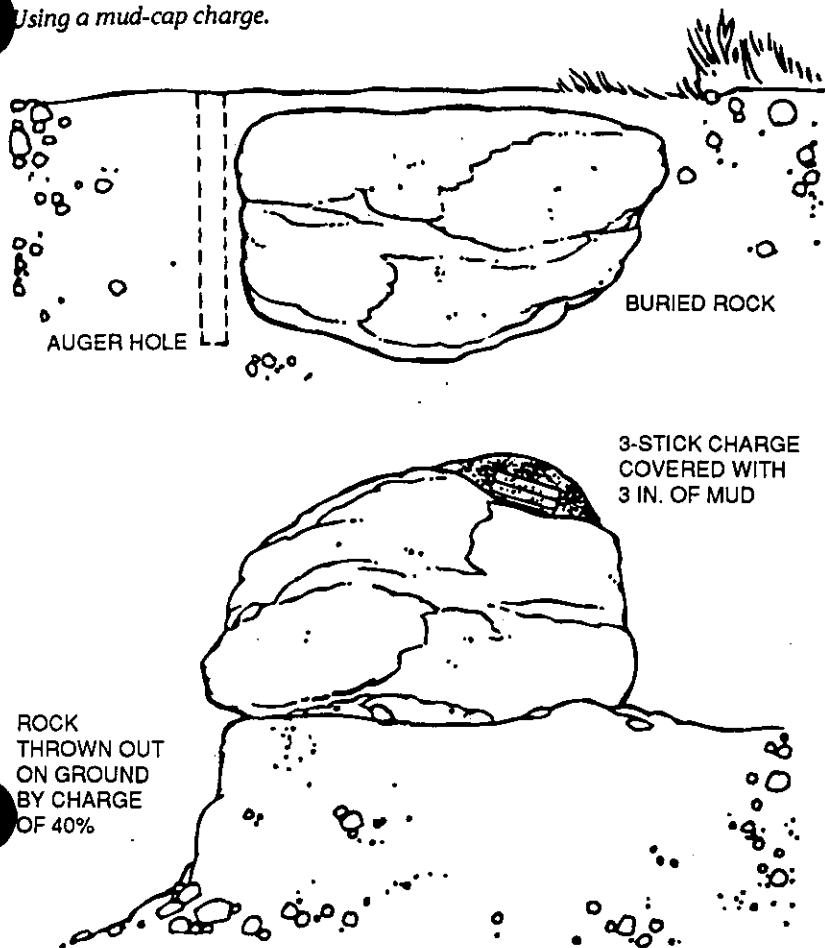

Dad asked me if I could help him do something before the new channel got deep and permanent. I said I could, but that it would cost as much as twenty dollars or more for dynamite. In retrospect, the amount was so trivial it is embarrassing, but at the time, having money for two or three cases of dynamite seemed horribly extravagant.

Dad immediately took the truck down to the hardware store. He bought two fifty-pound cases of 60-percent, plus a coil of fuze and a half box of caps.

I didn't know how much powder to use or how long to make the fuzes. The rule of thumb when hitting ice is to use three times as much powder as seems necessary. Length of time on the fuze could only be learned by experimenting.

I cut two identical lengths of fuze six feet long, capped them to two different sticks of dynamite, and put them back in the box. We

tied the box shut securely with baler twine.

At the river I lit both fuzes at as close to the same time as possible and pushed the case into the freezing, ice-swollen current with a long stick.

A full case of dynamite in water doesn't really sink or float. It kind of bumps along half under the surface. We kept track of its progress by watching for the smoke from the fuze. Unless it is put in the water too quickly or goes too deep, dynamite fuze will burn pretty well under water.

Driven by the current, the case bumped along under the great ice pack. Huge chunks of floating ice, backed up perhaps two hundred yards, soon obscured the progress of the drifting bomb.

After about five minutes, the case went off about one-third of the way down the ice pack. It sent huge chunks flying nicely into the trees standing ankle deep along the swollen river bank. A shock wave rippled downstream, almost taking out the jam, but mostly the log and

ice pile-up stood firm.

We rigged the second case. I cut the fuze off at ten minutes (ten feet) and double-capped it again.

This time the charge took so long it was at first monotonous and then scary as we began to think we had a misfire. It finally went with a nice roar, right at the head of the jam.

After about ten minutes, the river started to move again in its traditional banks. The stream across our river-bottom field diminished in intensity. Thanks to the explosives, our property remained intact.

Dynamite is, of course, useful when one is after large numbers of fish. The fact that fuze will burn up to ten feet under water is very helpful when one is pursuing that activity.

If there is a question, at times I will place the entire cap charge and coiled fuze in a thin plas-

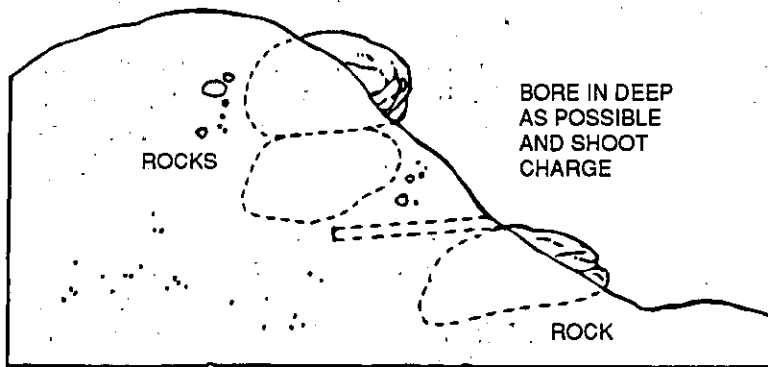

BORE IN DEEP
AS POSSIBLE
AND SHOOT
CHARGE

Road building.

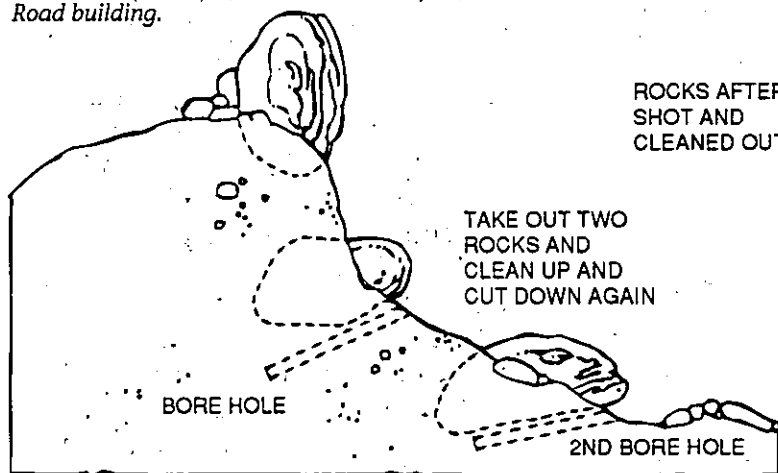

ROCKS AFTER
SHOT AND
CLEANED OUT

TAKE OUT TWO
ROCKS AND
CLEAN UP AND
CUT DOWN AGAIN

BORE HOLE

2ND BORE HOLE

tic bag. Water pressure collapses the bag, protecting the burning fuze and cap charge a bit. I am not absolutely certain that this allows me to go deeper with my charges, but I think it does.

No particular care need be taken with cap charges set for regular propagation sets when ditching with powder. The water is never deep enough to be of concern.

We used dynamite to clean out drainage tiles, blast holes for end posts or fence lines, clear log jams, and knock the limbs from old, dead, "widow maker" trees we were clearing before we cut them with a chain saw.

Using dynamite greatly expands one person's ability to accomplish uncommonly difficult tasks. This list may be a bit archaic, and is certainly not all-inclusive, but it does illustrate to some extent the range of activities that can be undertaken using common explosives.

CHAPTER 20

IMPROVISED DETONATING CAPS

Alfred Nobel's discovery of the principle of initial ignition (blasting caps) in 1863 may be more significant than the work he did pioneering the development of dynamite itself. Without the means of safely detonating one's explosives, the explosives are of little value. As I demonstrated in the chapter on ammonium nitrate, it is not particularly difficult to come up with some kind of blasting agent. Making it go boom somewhat on schedule is the real piece of work in this business.

Finding something to use for a cap is a different kettle of fish. Usually under the facade of safety, blasting caps are the first item to be taken off the market by despotic governments.

There are at least two reasonably easy, expedient methods of making blasting caps. The formulas are not terribly dangerous but do require that one exercise a high degree of caution. Caps, after all, are the most sensitive, dangerous part of the blasting process.

Improvised caps have an additional element of risk due to the fact that they are sensitive to relatively small amounts of heat, shock, static electricity, and chemical deterioration. The solution is to think your way carefully through each operation and to make only a few caps at a time. By doing so, you will limit the potential damage to what you hope are acceptable levels.

Fuze and electric-sensitive chemical mixtures are best put in extremely thin-walled .25 ID (inside diameter) aluminum tubing. If the

tubing is not readily available, use clean, bright, unsquashed, undamaged .22 magnum rimfire cases. Do not use copper tubing unless the caps will be put in service within forty-eight hours of their manufacture. Copper can combine with either of the primer mixtures described below, creating an even more dangerous compound.

For fuze-type caps, empty .22 mag brass should be filled to within one-quarter inch of the top of the empty case. This unfilled one-quarter inch provides the needed "skirt" used to crimp the fuze to the cap.

Fuze can often be purchased. If not, make it yourself out of straws and sugar chloride powder.

Two mixtures are fairly easy when making the priming compound for blasting caps.

Crush to fine powder two and a half teaspoons of hexamine (military fuel) tablets. Make sure you use hexamine. Sometimes hexamine is confused with trioxaine, a chemical that is used for basically the same purpose. Often, but not always, hexamine is white, while trioxaine is bluish.

Hexamine is available at many sporting goods stores and virtually all army surplus shops. Many of the survival catalogs also carry it, often in larger quantities at reduced prices. I personally favor ordering my hexamine from survival catalogs to be more certain of what I am getting.

Many clerks in sporting goods stores seem to have undergone lobotomies as a qualifica-

tion for the job. In my experience, they will either try to talk you out of hexamine if they don't have it, or try substituting something else (suppositories, for instance) if they can't determine for sure what it is they have or exactly what you want.

As of this writing, a sufficient amount of hexamine to make two batches of caps costs from \$.75 to \$1.50.

Place the finely powdered hexamine in a clear glass mixing jar. A pint-sized jar with an old-fashioned glass top is perfect for the job.

Add four and a half tablespoons of citric acid to the two and a half tablespoons of crushed hexamine. Stir with a glass rod until the mixture is a slurry. The citric acid can be the common variety found in the canning department of the grocery store. It is usually used to preserve the color of home-frozen and canned fruit and sells for about \$1.59 per bottle.

The final mix involves pouring in a tablespoon of common peroxide. Use the stuff bottle blondes are famous for that is 20- to 30-percent pure by volume, available from drugstores. This material is the cheapest of the ingredients, costing roughly one dollar per bottle.

Shake the mixture vigorously for at least ten minutes, until everything appears to be in solution. Set the mixing jar in a dark, undisturbed spot for at least twelve hours. Be sure this place is somewhat cool as well as dark. Don't put it in the basement on top of a heat duct, for instance.

After a few hours of undisturbed, cool shelf sitting, a white, cloudy precipitate will begin to appear. At the end of twelve hours, there should be enough to load three blasting caps. Making enough chemical for three caps is just right, in my opinion. Anything more in one batch is too risky.

Filter the entire mix through a coffee filter. Run four or five spoons of isopropyl alcohol through the powder to clean it.

Spread the wet, filtered powder on a piece of uncoated, tough paper. Don't use newspaper or magazine covers. Notebook paper or a paper bag is ideal.

Allow the powder to dry in a cool, dark place. The resulting explosive is very powerful. It is also very sensitive, so use caution. In my opinion, the concoction is about three times as powerful as regular caps of the same size.

Using a plastic spoon, fill the presorted and precleaned .22 mag cases with the powder. Pack the powder down into the case with a tight-fitting brass rod. I have never had an incident, but for safety's sake I still use a heavy leather glove and a piece of one-quarter-inch steel clamped in a vise to shield me when I pack in the powder. The end result is a very nice cap, ready to clamp on the fuze in the customary fashion.

If a piece of tubing is used in place of a mag case, securely crimp or solder one end shut. It will not do to have the powder leak out of the cap. Powder contact with the solder should be kept to a minimum. Fingernail polish can be used to seal the lead away from the chemical.

It is possible and perhaps desirable to continue on and turn these caps into electrically fired units, but more about that later. First we'll discuss another good formula that uses equally common materials. This one is a bit better because the mixture involves all liquids, but it is temperature critical and should therefore be approached with special care.

Mix 30 milliliters of acetone purchased from an automotive supply house with 50 milliliters of 20- to 30-percent peroxide purchased from the corner bottle blonde. There are about 28 milliliters per ounce. Adjust your mix on that basis if you have nothing but English measures to work with.

Stir the acetone and peroxide together thoroughly. Prepare a large bowl full of crushed ice. Mix in a quart or so of water and about one-half to two-thirds pound of salt. Place the pint jar with the acetone and peroxide in the salt ice cooling bath.

Measure out 2.5 milliliters of concentrated sulfuric acid. Sulfuric is available from people who sell lead acid batteries. Using an eyedropper, add this to the mixture one drop at a time. Stir continually. If the mixture starts to get hot,

Building and Keeping Your Arsenal Secure

Homemade
blasting
caps.



TOP OPEN TO ALLOW FUZE CRIMP

EMPTY .22 MAG CASE (CLEAN,
UNDAMAGED, UNDENTED)

FILL WITH CHEMICAL
TIGHTLY PACKED IN CASE

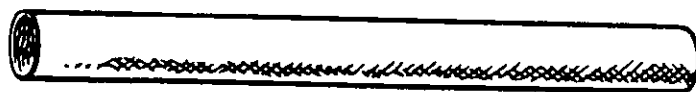

1/4-IN. ID THIN WALL ALUMINUM TUBING

TOP 1/4 IN. LEFT
UNFILLED FOR CRIMP

CRIMP END OF TUBE

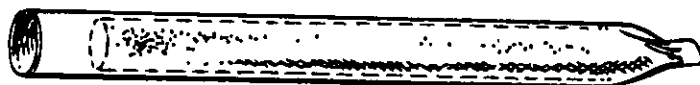

TUBE FILLED WITH CHEMICAL

THIN, NONCOPPER WIRE
EMBEDDED IN CAP CHEMICAL

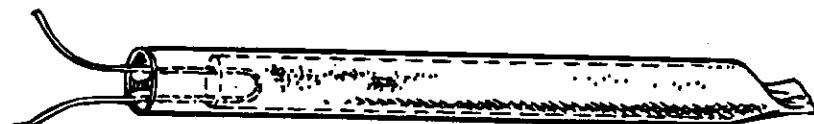

GLUE HOLDS WIRE

1/4-IN. ID ALUMINUM TUBING

GLUE PLUG HOLDS
WIRES IN PLACE

CAP CHEMICAL

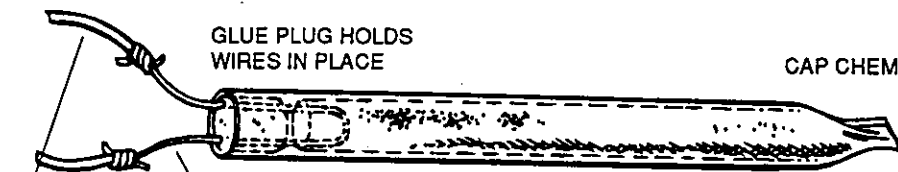

HEAVIER
LEAD
WIRES

VERY THIN
NICHROME WIRE

FILLING OF FFFF6 BLACK POWDER OR
SUGAR CHLORATE POWDER AS BOOSTER

stop adding acid and stir as long as it takes for the temperature to start to drop again.

After all the acid has been added, cover the jar and set it in the refrigerator for twelve hours. Try not to disturb or shake the jar by opening the refrigerator needlessly.

Again, a white, cloudy precipitate will form in the bottom of the pint jar. As before, filter through a coffee filter, but wash it with a couple of spoons of distilled water.

Spread on paper and dry. Like the first material, this batch will produce enough powder for about three caps. These are pretty hefty caps, having about three times the power of regular dynamite caps.

They should set off ammonium nitrate, but don't be surprised if they don't. I have never tried it, but making two caps from a batch rather than three might create a cap with enough heft to detonate ammonium nitrate reliably. The problem then is that .22 mag brass does not have enough capacity. You will have to go to a hardware store to find suitable aluminum tubing.

Electrical caps, because of the fact that bridge wires must be included in the package, must be considerably larger than fuze caps.

For making electrical caps, use any fine steel wire that is available. I use nichrome .002 diameter wire purchased from a hardware specialty shop. Hobby shops are also a source of this wire. Copper wire is easiest to obtain but should not be used because

of its possible reaction with the blasting material.

I strongly urge that an experimental piece of proposed bridge wire be placed in a circuit with a 12-volt car battery, a wall outlet, or whatever power source will be used. The wire should burn an instantaneous cherry red when the current is applied. If it doesn't, use a smaller diameter wire.

Having located a usable wire, cut the

thread-thin material into six-inch pieces. Bend these into a U and place them in the bottom of the tubes. Pack the recently manufactured cap explosive in around the wire. Seal the cap off with silicon caulk. Allow the cap to cure for several days. The last step is to attach the lead wires to the thin bridge wires. The job can be tougher than one would suppose because of the thinness of the bridge wires. Be sure the connection is secure and solid. Use tiny mechanical clamps as necessary and, of course, do not even think about soldering the wires after they are embedded in the primer.

For some unknown reason, some of my mixtures have not detonated well using a heated bridge wire. To get around this, I have occasionally loaded two-thirds of the cap with hexamine or acetate booster and

one-third with FFFF6 black powder or sugar chlorate powder, whichever is easier and more available.

The chlorate or black powder ignites much more easily, in turn, taking the more powerful cap mixture with it. Concocting this combination is, of course, dependent on having the necessary materials.

If black or sugar powder is not available, the caps can usually be made to work reliably using only the original cap powder.

Making these caps requires more than the usual amount of care and experimentation. The procedure is workable but dangerous. Blasters who can secure commercial caps are advised to go that route. But if not, these caps are workable and, in total, not all that tough to make.

CHAPTER 21

INTRODUCTION

Survivors generally agree that commercial explosives lend themselves best to commercial applications. Paramilitary survival explosives, as a general rule, need to be more powerful. For instance, store-bought dynamite will not cut steel or shatter concrete (usually).

Many survivors believe that there are times ahead when they will need an explosive equivalent of military C-4, or plastique. However, as with the lottery, fire department, and post office, which are monopolized by various government agencies, the federal government monopolizes C-4, making it next to impossible to purchase. Survivors can't count on buying and caching military explosives against the day of need.

According to standard military charts, straight 60-percent commercial dynamite, the most powerful grade generally available to the public, has a detonation velocity of approximately 19,000 feet per second (fps). Military TNT detonates at about 22,600 fps. TNT is considered to be the minimum grade of explosive required by survivalists and paramilitarists who want to cut steel and shatter concrete.

C-4, the acknowledged big-league explosives benchmark, detonates at a speedy 26,400 fps. C-4 may seem to be ideal for your survival needs, but, as with many somewhat worthy objectives, the game may not be worth the candle. Mixing up a batch of C-4 may not be worth the risk. It is both dangerous and illegal.

Seymour Lecker, in his excellent book, *Improvised Explosives*, quotes the famous paramilitarist Che Guevara: "Fully half of the people we assigned to explosives-making were eventually killed or maimed." Even the best, simplest formulas are dangerous. The one that follows is no exception. It is the safest formula that I know of, but even at that, a certain percentage of those who try to make this explosive will end up as casualties.

Federal laws regulating explosives manufacture are extremely strict. Home manufacturers can receive penalties of up to \$10,000 and/or ten years' imprisonment. If personal injury to other parties results from the experiments, fines and jail sentences can be doubled.

Although there are ominous signs on the horizon, the United States does not yet seem to be part of a completely totalitarian society. In that regard, anarchy may be premature. However, this is purely a matter of personal perspective. Times and events can change quickly. Processes that may now appear unduly risky from a chemical, legal, and sociopolitical standpoint may soon be entirely acceptable. Each reader should know the risks and then apply his own standards.

If you think that you would like to have C-4 now (or possess the capability of making it at some later date), this book is for you. What follows appears to meet most survivors' specifications for a military-grade explosive. If you follow instructions carefully, the material is rela-

tively safe to manufacture, but, of course, making or having it was illegal at the time this book went to press. To solve this dilemma, you

may choose to master the necessary skills and store this knowledge away with the necessary ingredients in case you need them later.

CHAPTER 22

AMMONIUM NITRATE

One may be amazed to find that something as common as agricultural-grade ammonium nitrate (NH_4NO_3) is the basis for a huge number of explosives. Ammonium nitrate is readily available on a year-round basis. Farms of every size regularly use hundreds of tons of this fertilizer.

Ammonium nitrate is often the preferred source of nitrogen for such crops as corn, wheat, beans, and barley. Farmers use it whenever they need a source of relatively stable, long-lasting agricultural nitrogen. This is especially surprising since the concentration of nitrogen per bag is relatively low, making this nitrogen source expensive for many cost-conscious farmers. Ammonium nitrate costs as much as \$9 per 80-pound bag in farm supply stores and up to \$15 per 60- or 80-pound bag in garden-supply stores where profit margins are steeper.

Ammonium nitrate was first produced in the early 1860s by Swedish chemists. The process they developed is the same one used today by major fertilizer manufacturers. The process entails putting natural gas under great pressure, mixing it with superheated steam, and injecting the mixture into a conversion chamber lined with a platinum catalyst. After the reaction is underway, the generated heat causes the process to be self-sustaining.

Pure liquid ammonia produced by this process is combined with nitric acid, which is also produced by most ammonium-nitrate manu-

facturers. (Many producers sell nitric acid to other manufacturers for use in their manufacturing operations. Although U.S. production of nitric acid and ammonium nitrate is now virtually absorbed by agribusiness, most of the plants were started with government subsidies as explosives manufacturers.) Combining nitric acid and ammonia produces salts, which after being dried and prilled should be 34 percent nitrogen.

Some fertilizers marked ammonium nitrate may actually be something else. Manufacturers often add a calcium coating to ammonium nitrate because it is deliquescent, which means it pulls moisture out of the air. Uncoated, unprilled ammonium nitrate will quickly harden into a substance resembling green concrete. Anything more than a slight calcium coating, however, will keep the activating liquid (in this case, nitromethane) from soaking into the ammonium nitrate, just as it prevents the absorption of water. If the manufacturer adds more than a minute coating of calcium, he must mark the bag appropriately. Don't use this material.

Although fertilizer-grade ammonium nitrate can usually be purchased from nurseries and garden-supply stores, a better source for explosives manufacture is farm-supply stores. Garden-supply outlets often stock fertilizers that are blends of ammonium nitrate and other fertilizers. Blends are absolutely unacceptable even if they claim to

contain a base of ammonium nitrate. Buy only pure ammonium nitrate because any other additives dramatically reduce its explosive effectiveness.

Sales clerks often will try to get you to substitute urea or ammonium sulfate for ammonium nitrate. They point out that the substitute is less expensive, more stable, has just as much nitrogen, and is a prettier color. (I customarily explain that I need pure ammonium nitrate because I intend to blow up the material. This approach works best in rural stores. Urban clerks, used to supplying yuppie rose growers, may look askance at this sort of honesty.)

Would-be home-explosives manufacturers must learn to read fertilizer bags, at least in a superficial sense. The figures listed on the bag refer to the ratio of nitrogen, phosphorous, and potash contained in the product. Ammonium sulfate will be listed as 21-0-0 or something close. Urea, which can contain from 46 to 48 percent nitrogen, would read 46-0-0. Blends such as 21-44-8 con-

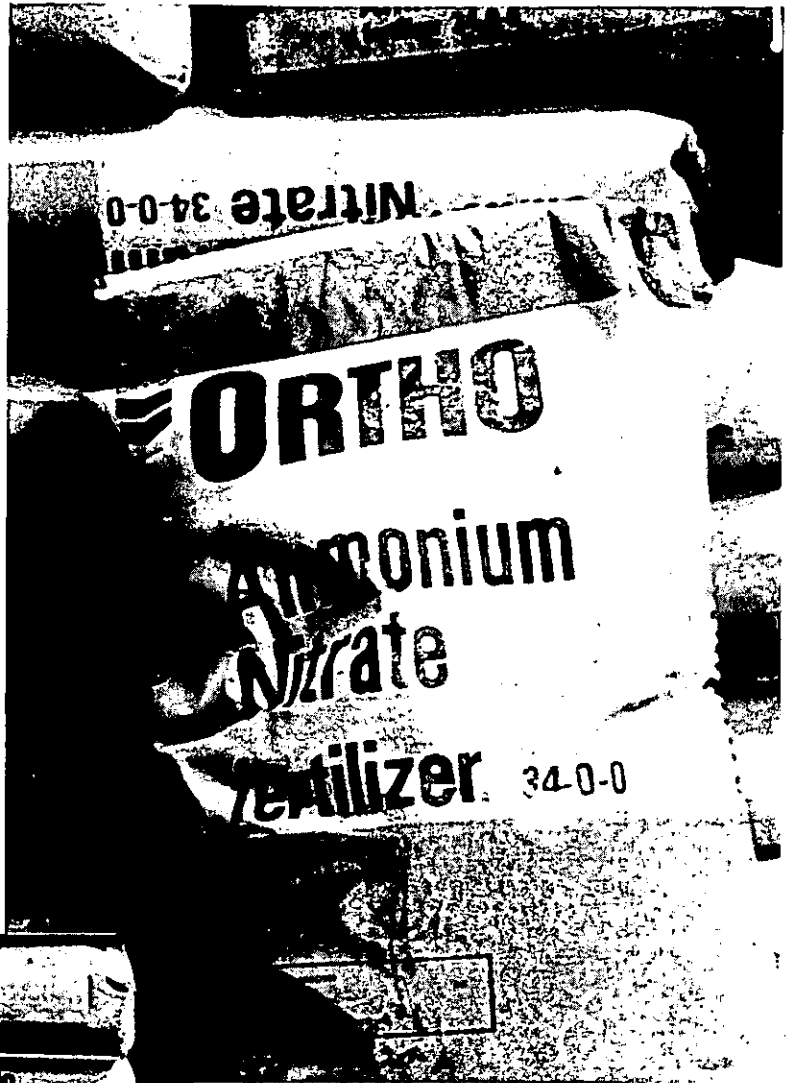

Ammonium nitrate, a common garden and farm fertilizer, is available year-round throughout the United States at farm- and garden-supply stores.

Buy only sealed bags of ammonium nitrate labeled 34-0-0. The figures represent a ratio of nitrogen, phosphorous, and potash. You want a fertilizer that contains 34 percent nitrogen, no phosphorous, and no potash. Don't be persuaded by salespeople to substitute other blends or products. Buy the freshest fertilizer you can find and seal it immediately in double garbage bags as soon as you get home.

tain 21 percent nitrogen, 44 percent phosphate, and 8 percent potash. These and other similar substitutes are worthless for anything other than fertilizing. Only ammonium nitrate contains a ratio of 34-0-0.

On arriving home with the 34-0-0 fertilizer (if you're not planning on using it right away), seal the unopened bag

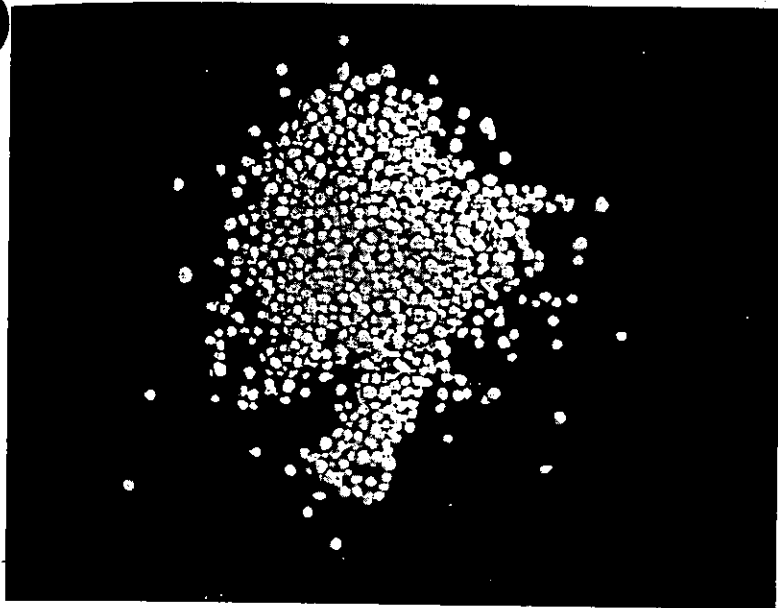

Fertilizer-grade ammonium nitrate is exuded into small seed-sized prill and then coated with a thin layer of calcium. The calcium coating is a mixed blessing. It is necessary to keep the prill from absorbing moisture and hardening into a concretelike substance, but it also prevents the activating liquid (in this case, nitromethane) from soaking into the prill.

Ammonium nitrate is properly sold in plastic-lined bags, not from bulk bins) in at least two heavy-duty plastic garbage bags. Of course, any partially full bags should also be sealed thoroughly to prevent moisture absorption. Under many circumstances in the United States, it is virtually impossible to store ammonium nitrate for any length of time and still maintain usable ingredients.

Ammonium nitrate has been involved in some spectacular explosions during this century. Well over 3 million pounds of ammonium nitrate accidentally detonated in the harbor at Texas City, Texas, in 1947. Oppau, Germany, was blasted right off the map in 1921 by a free-roaring ammonium nitrate blast. (For more information about these and other great explosions of history, read *Fire,*

Flash, and Fury by Ragnar Benson, Paladin Press.) However, in spite of these notable accidents, ammonium nitrate is relatively safe to handle.

Many farmers store it in barns just a few feet from the house. An unlikely combination of heat and contamination by oils or coal dust can cause problems, but as a general rule, I would not be fearful of keeping the material under my bed. It is inert, as road builders, quarry operators, farmers, contractors, and others who use it as an inexpensive blasting agent find out. Ammonium nitrate must be soaked with fuel oil and/or mixed with powdered walnut hulls, coal dust, or another source of carbon to make it active. Even with these combustible additives, I find it terribly difficult to make ammonium nitrate detonate.

Officially, ammonium nitrate is considered only a blasting agent, but it does have some explosive applications.

During World War I, the British, who were low on military explosives, used a million pounds of ammonium nitrate laced with TNT and powdered aluminum to stage a successful sapper attack against the German lines at Messines Ridge in Belgium. Later on, continuing through World War II, the French and Germans both loaded their high-explosive artillery and mortar rounds with ammonium nitrate explosives.

Although many countries around the world now prohibit the sale or possession of ammonium nitrate, it is commonly available in the United States and will probably continue to be for the foreseeable future. At this time, buying an 80-pound bag should be no problem for anyone (even city dwellers) with ten dollars and a means of carting it off.

CHAPTER 23

NITROMETHANE

Nitromethane is the second of three chemical components needed to put C-4 together in one's home chemistry lab. The material is somewhat obscure, expensive, and at times desperately time-consuming to obtain. On the other hand, it is reasonably safe to handle and can be located if one applies oneself to the task.

Nitromethane (CH_3NO_2) is used in many organic chemistry laboratories as a washing solvent and is found in virtually every college chemistry lab. Industrial firms use it to dissolve plastics, clean up waxes and fats, and manufacture numerous chemical-based products.

More commonly, nitromethane is used as a fuel additive. Model-plane enthusiasts mix it with castor oil and alcohol to power their miniature engines. It is also used to fuel small indoor race cars and go-carts. But the largest group of consumers commonly available to survivors is drag racers. It is not uncommon for quarter-milers to burn gallons of this expensive fuel on every run.

As a result, the best place to look for nitromethane is at drag strips and stock-car races. Often a local petroleum dealer will bring a 55-gallon barrel of the fuel to the track and sell it by the gallon to the drivers and mechanics. As a result, those who can't afford 55 gallons can buy enough to compete that night.

In some larger cities, petroleum dealers handle the fuel on a limited basis. An hour or two on the phone may uncover a dealer who will sell it by the gallon. Most bulk petroleum

dealers will special-order a full barrel, but at \$1,925 per barrel (based on \$35 per gallon), few survivors would be interested.

Another likely place to look for nitromethane is in hobby shops. Most carry pre-mixed model engine fuel, containing up to 40 percent nitromethane. Theoretically, this fuel mixture should activate ammonium nitrate, but my experience using it is mixed at best. Perhaps if the fuel is fresh and dry, it might work consistently. Yet, in spite of extensive testing, I have not achieved even a 30-percent success rate using high-concentration model fuel. The problem appears to be the alcohol which, when mixed with the fuel, pulls moisture out of the air even when the bottles are well sealed.

A few well-stocked hobby shops carry six- or eight-ounce bottles of nitromethane. Most will special-order it by the gallon at considerably more than \$35 per gallon. Model-plane enthusiasts usually do not use fuel containing more than 15 percent nitromethane because it will burn up their expensive little engines. So survivors probably won't find more than a gallon or two of the high-concentration, 40-percent fuel even in well-stocked hobby shops. If they do find it, it probably will not work consistently.

If all else fails, nitromethane can be ordered at extremely high prices from chemical supply houses. Most will sell it to individuals since nitromethane does have a number of valid "civilian" uses. Check survival magazines for

addresses or borrow a Fisher or Sigma catalog from the local high-school chemistry department. It may be possible to locate local industrial or commercial users who are willing to sell a few spare gallons.

Officially, nitromethane is categorized as a Class 3 conflagrant, meaning it reacts to open flame on about the same level as gasoline. It is not highly sensitive to shock. At drag strips, dealers drop barrels of nitromethane off their trucks or roll them around with impunity. They seem little concerned with the consequences of rough handling.

However, nitromethane is moderately toxic if ingested or inhaled. People who have ingested the material may suffer from nausea, vomiting, and/or diarrhea. Heavy or regular ingestion can result in permanent damage to the kidneys. Nitromethane is about as toxic and explosive as leaded gasoline in its original state.

Nitromethane is much less costly today than when it was developed at the turn of this century. Initially, it was made by reacting methyl iodide with silver nitrite. The resulting product was combined through the Kolbe reaction method, using chloroacetic acid. At the time, nitromethane explosives were considered effective but far too expensive to merit large-scale production.

Today, nitromethane is manufactured by

injecting nitric acid into a high-pressure chamber containing superheated methane gas, a relatively inexpensive process. At temperatures of 400°C the reaction becomes self-sustaining. Because its price has decreased so dramatically, nitromethane is encountered more frequently today as a fuel additive and in laboratories.

Pure nitromethane is a thin, syrupy, yellow liquid. It smells a bit sweet, but the odor is subtle enough that it is not readily recognized. Food coloring can be safely added to camouflage the liquid, if you desire. When lit, nitromethane burns brightly with considerable heat and force until the fuel is consumed. In its pure, unmixed form, it has a shelf life of about four years before moisture destroys it.

As with ammonium nitrate, possession of nitromethane is not controlled except perhaps in isolated local instances. Nitromethane can be stored by survivors for relatively long periods in plastic or steel containers. If one does not spill large amounts of the substance in an unventilated space or suck one's thumb after using it, nitromethane is relatively benign.

The challenge for survivors entails finding a source of affordable nitromethane, which may mean putting a long-term, well-programmed procurement plan into place.

CHAPTER 24

HOME MANUFACTURE OF C-4

Making homemade C-4 requires one more chemical: denatured ethyl alcohol. This ingredient is so common and so safe that no further discussion is required—except to emphasize the importance of using *fresh* alcohol, preferably purchased from a paint-supply store.

Having come this far, most readers will agree that we are dealing with some fairly benign chemicals. Now the trick is to combine them in an effective and reasonably safe manner. As with most things in life, there is a downside. The process is not nearly as simple as one would hope, but it is possible, even for chemists with only high school training, to carry it out.

My strong suggestion remains that anyone contemplating home manufacture of C-4 think through both the process and the consequences thoroughly before proceeding. The following procedure yields an extremely powerful explosive. It dwarfs anything available on the commercial market. Even 80-percent Hy-Drive dynamite pales into firecracker class compared to the explosive you may produce.

Those who decide to proceed are also reminded that 1) they are probably violating federal law, and 2) they should already know how to handle conventional commercial explosives competently before attempting this procedure. Experimenters should start with small test batches, remembering that those who fail to use caution, common sense, and care could face disastrous results.

Compared to manufacturing some other explosives, producing this C-4 substitute is not particularly difficult or dangerous. What danger does exist comes when combining the materials, which can be done at the last moment immediately preceding actual use.

Nevertheless, the procedures are exacting. Those who are untrained in chemistry or who are sloppy or careless will not succeed. Now that my warning is complete, let's begin.

The first step is to dry the ammonium nitrate and keep it dry. Where the humidity is high, this is a difficult to virtually impossible task.

Start by taking a one-pound coffee can or its equivalent from a freshly opened bag of ammonium nitrate. The coffee can will hold one-and-one-half to two pounds of prilled ammonium nitrate. A one-pound can provides a greater height relative to diameter, which makes the volume less dense and aids in its drying. Seal the unused bag of ammonium nitrate away in double plastic garbage bags immediately after removing the amount needed.

Place the can in an electric oven set at the lowest possible setting and dry in the oven for a minimum of three hours. Be careful that the temperature never goes above 150° F. (Doing this properly will require a good-quality, lab-grade, dial-read thermometer available from chemical supply firms or catalogs.)

Ammonium nitrate liquefies at about 170°F and will blow at about 400°F. Before it

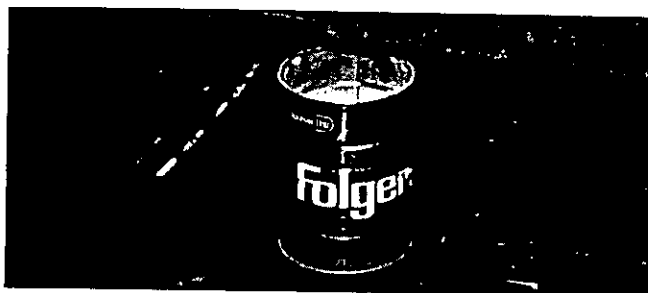

Scoop out roughly two pounds of the ammonium nitrate prill into a one-pound coffee can. (The height relative to the diameter of the one-pound can makes the volume less dense and aids in drying.) Dry the prill in an oven set at a low temperature (not to exceed 150° F) for at least three hours, but don't let the prill melt. Ammonium nitrate vapors are toxic, so it is essential that the temperature stays low and the room is well-ventilated. On completion of the heating cycle, cap the can immediately and seal in double garbage bags. Even double sealed, the dried ammonium nitrate will absorb moisture and can be stored for no more than twelve days.

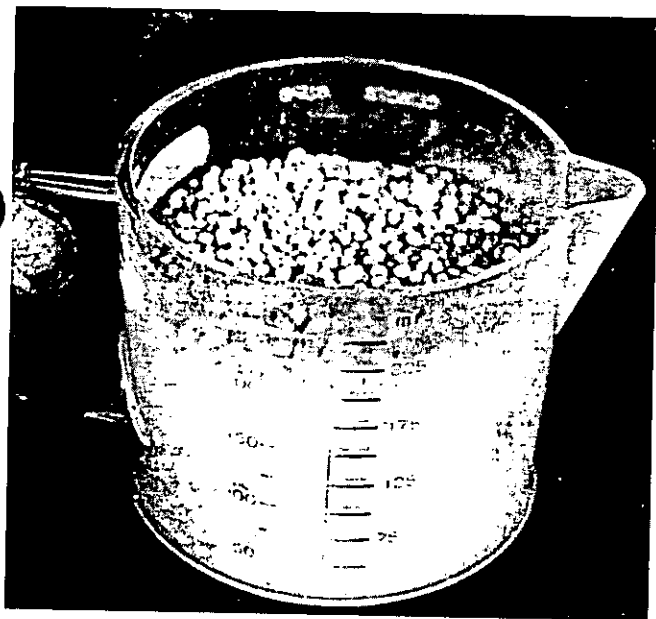

Measure exactly 250 milliliters of dried ammonium nitrate prill. The specific gravity of ammonium nitrate is 1.725, yielding a sample of 430 grams.

explodes, it will bubble and smoke, providing adequate warning to remove it from the heat.

On completion of the heating cycle, seal the dried prill in the coffee can and place it in double, sealed plastic bags. At most, this material will last ten to twelve days before absorbing too much moisture—even though it is triple-sealed. Always make sure the seals are completely zipped and airtight.

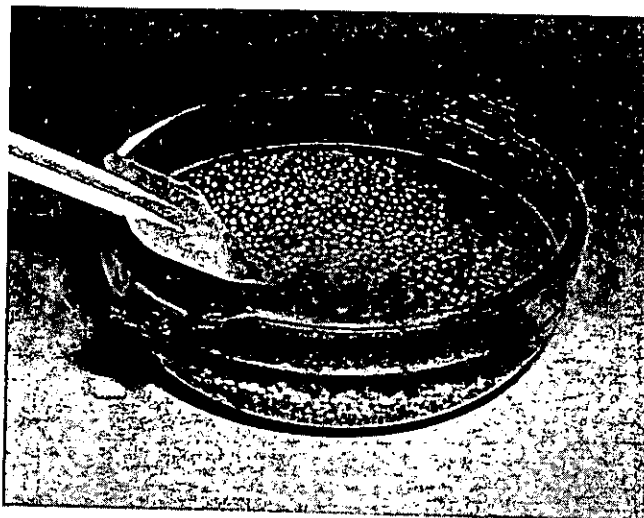

Place the ammonium nitrate in a glass dish, cover with alcohol, and stir thoroughly for about three minutes.

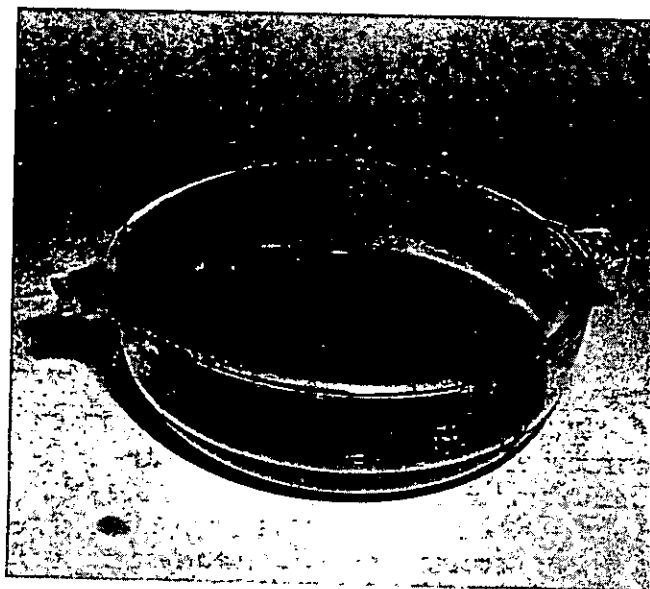

The alcohol will remove a brown sludge from the ammonium nitrate. As soon as the alcohol turns brown, the process is completed. Throw the alcohol away.

Place about 250 milliliters (about 430 grams) of this oven-dried material in an oven-proof glass dish. Cover the prill with the type of denatured ethyl alcohol used to carry moisture out of gas lines (available from paint and automotive supply houses at about seven dollars per gallon).

Stir this mixture around for about three minutes or until the alcohol turns a muddy,

Building and Keeping Your Arsenal Secure



Strain the alcohol from the prill and heat gently (I prefer an electric wok, but you can use a hot plate or stove top). Stir constantly and use an accurate thermometer to make sure temperature stays below 150°F.

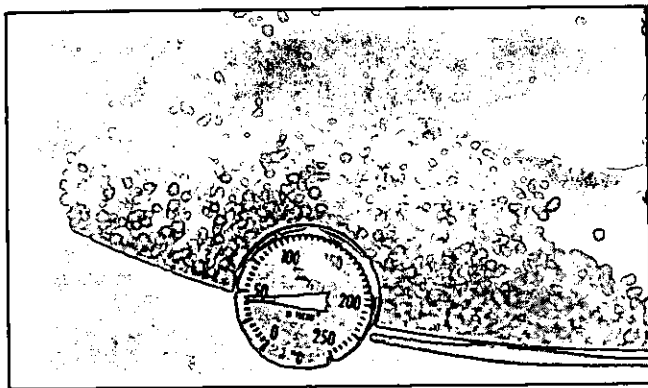

Heat for three or four minutes until the alcohol is completely evaporated.

cloudy brown. Drain off the alcohol by straining through a seine or screen. Dump the 430-gram sample back into the dish and gently heat over low heat. (I use a stainless-steel wok at the lowest heat setting, but you could also use your stove top or a hot plate.) Use a thermometer to be certain the sample stays below 150°F.

Immediately after the alcohol wash, grind the prill to avoid moisture absorption. Various methods can be used to do this. Some survivors use two flat hardwood boards, a mortar and pestle, or even an electric coffee grinder. By whatever means, reduce the prill to talcum-powder consistency.

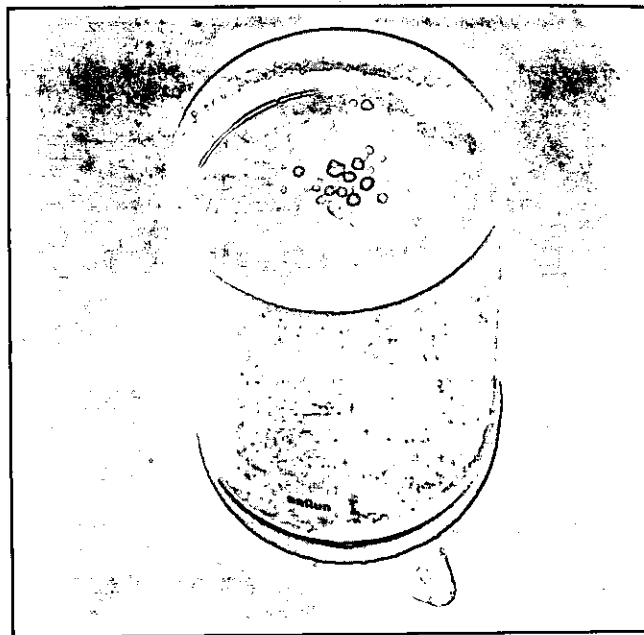

To grind the prill, I use an electric coffee grinder, but a mortar and pestle or two boards also work.

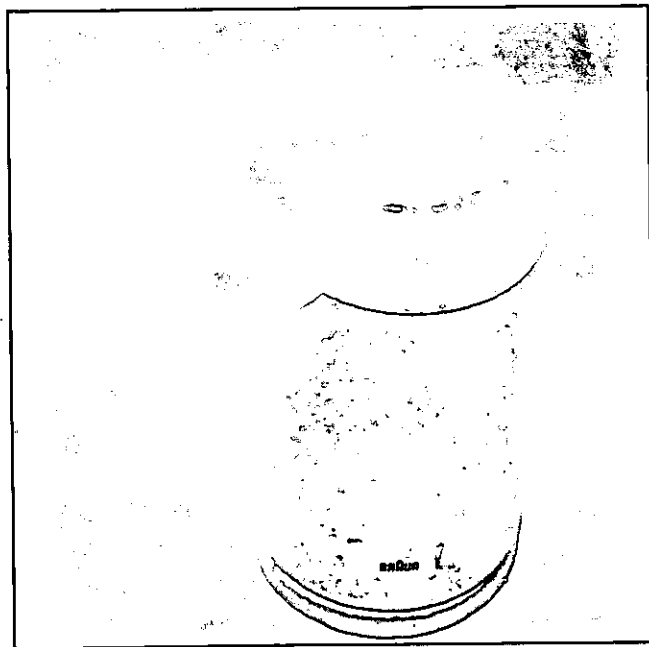

Grind the prill to a fine talcum-powder consistency.

(If the prill is not ground finely enough, it may be necessary to sieve the powder. It is hoped this step will be unnecessary. Makers will note that the ammonium nitrate begins to cake and lump from moisture when removed



Dump the finely ground ammonium nitrate into a solid container immediately after grinding. It is extremely deliquescent (moisture-absorbent), so seal it as soon as possible. Note the lumps starting to form immediately after exposure to air.

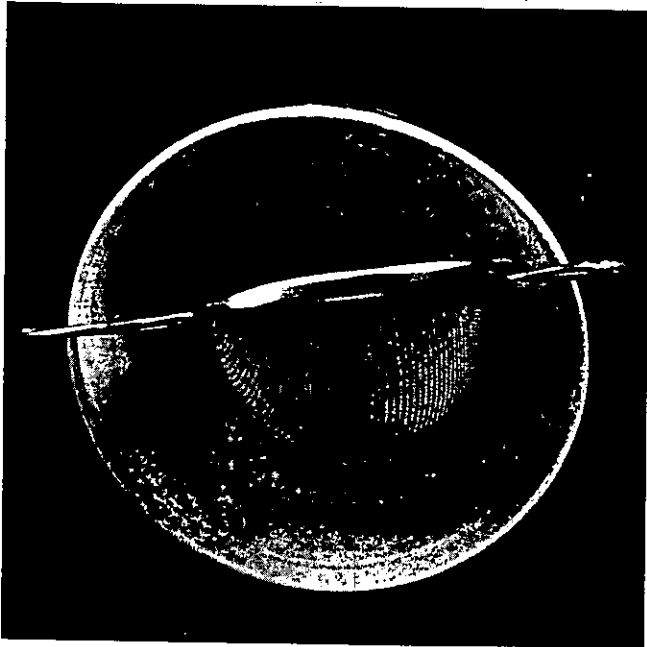

If the grinding process is not thorough, prill must be strained to remove coarse material. This step should be avoided if possible because it exposes the ammonium nitrate to moisture for a longer period.

from the grinder. Sieving only exacerbates this situation.)



Pack the dried, ground ammonium nitrate in an airtight plastic container, such as a pill bottle that will hold about 430 grams of powder and the nitromethane (430-gram charges are sufficient for most jobs survivors demand of an explosive). Solidly packed charges in rigid containers seem to have more force than charges held in loosely packed containers. Again, remember that the container for the ammonium nitrate must be absolutely airtight.



When combined, the powder blows a few bubbles and then cakes into a tough plastic substance. The explosive will be more powerful if the caking process is undisturbed. Combine the two materials at the blast site as a precautionary measure.

Quickly tamp or pack the powder into a container. This must be done before the ammonium nitrate begins to reattract moisture, so it isn't always possible to do a thorough job. Preventing moisture absorption is your primary concern, so work quickly.

When selecting a container, make certain that

Building and Keeping Your Arsenal Secure

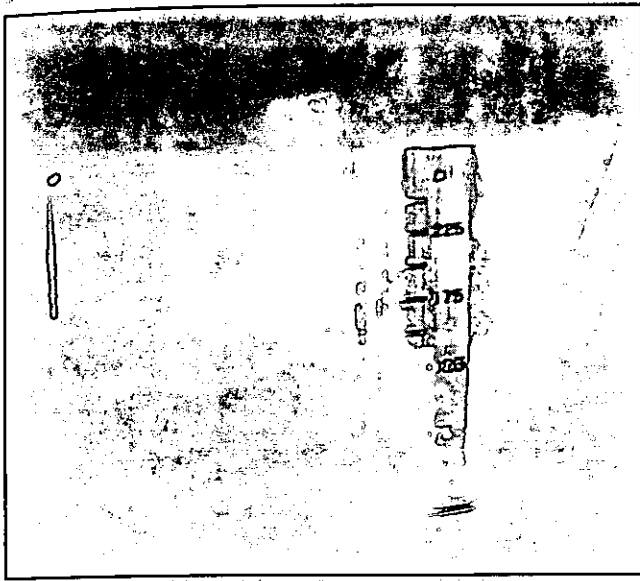

Mix 80 milliliters of nitromethane into the 430 grams of ammonium nitrate. The ratio should be approximately one-third nitromethane by volume or even two parts nitromethane to five parts ammonium nitrate by weight. Precise formulas must be determined by trial and error because reactions vary from sample to sample of nitromethane and ammonium nitrate.



Wait about twenty minutes for the nitromethane to soak into the ammonium nitrate. At this point, the material is cap-sensitive but does not readily detonate when dropped or shot with a firearm.

It is airtight. Old medicine or spice bottles work nicely. Some commercial makers use custom-made, thin-walled aluminum cylinders that look much like containers for high-priced cigars.

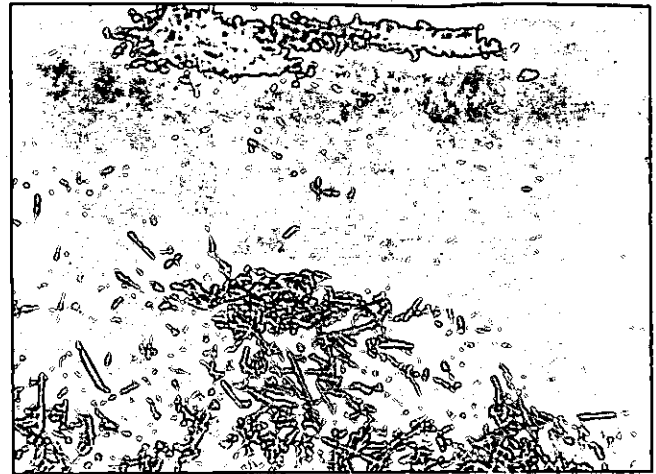

Adding powdered aluminum to the ammonium nitrate and nitromethane mixture produced this nine-inch hole in the foreground. A similar charge without the aluminum cut the seven-inch hole highlighted in the upper right corner. A comparable charge of dynamite merely skins the soft meadow ground without leaving a depression.

Although the finished product is doughlike and can be put in a plastic bag to mold around a girder or squash into a crack, it seems to have considerably more power when packed tightly in a rigid cylinder. I did not have a chronograph or any other means of measuring speed of detonation so it is impossible to make the above claim with certainty. However, the packed material produced larger holes in the ground because it apparently cakes better with the nitromethane when held tightly in a rigid configuration.

Whatever container is used, the maker must know exactly how many grams of ammonium nitrate it will hold. Also, there appears to be a minimum amount of powder that can be detonated. With less than 300 grams (about 10 ounces), it is tough to bury the cap thoroughly and secure a good detonation.

When deciding on container size and the amount of ammonium nitrate to use, remember to leave a small space at the top of the container for the liquid nitromethane. Using the correct amount of nitromethane to sensitize the ammonium nitrate is much more critical than one would first suppose. I avoided the need for scales by using metric measurements wherein weight and volume

using specific gravity become identical.

Despite almost driving our family into poverty by my many costly experiments, I still do not feel I have all of the answers pertaining to this process. My experiments indicate that one should use slightly less than one-third nitromethane by volume, but this seems to vary from one gallon of nitromethane to the next and from one bag of ammonium nitrate to the next. Too much nitromethane will kill the mixture, while too little will not sufficiently sensitize the ammonium nitrate.

When dumped on the powdered prill, the proper amount of nitromethane will cause the powder to bubble slightly. It is almost as if there were live clams in the container, blowing in the sand after the surf rolls over them. After about two minutes of soaking, the nitromethane—if the correct amount is added—will saturate the powder and turn it into a thick, porridgey mass. Too much nitro will produce a gruel that is too thin to fire.

I used plastic pill bottles that contained about 430 grams (about 11 ounces) of powdered ammonium nitrate, and they produced very powerful blasts. A hit from this much explosive is awesome and probably sufficient to demolish small bridges and trucks, and maybe even to knock tread off a tank. Certainly in groups of two or three fired together, it would do the job.

To this 430-gram container, I added about 75 to 80 milliliters of pure nitromethane. Getting just the right amount will require experimentation. Unfortunately, I know of no formula that states precisely how much nitromethane to use. As a rough starting point, try one part nitromethane to three parts of ammonium nitrate by volume or two parts nitromethane to five parts ammonium nitrate by weight. Theoretically, the material should sensitize in five minutes, but I get better results by waiting twenty minutes.

Once the nitromethane is poured into the ammonium nitrate, there is no need to be overly concerned about moisture getting into the powder. Water would, of course, wash the mash away if it were exposed, but

the plastic bottle should solve that problem. This explosive would not be the first choice for those undertaking underwater demolitions work, but it could be used if no other explosive material were available. When mixed, the shelf life seems to be a couple of weeks or more.

At this writing I am not aware of any reason—other than psychological—why this material could not be combined and sensitized ahead of time. Storing the mixed explosive does not seem any riskier than storing commercial dynamite. This mixture may deteriorate in time, but my experiments did not indicate this.

Although the combined material seems safe to handle, it is definitely exciting when detonated with a number six or eight cap. Commercial dynamite detonated on bare, hard ground will skin it up a bit. This explosive will dig six- or seven-inch holes without top tamping of any kind.

I estimate the velocity of detonation to be about 21,000 fps or slightly less than TNT, which detonates at about 22,600 fps. C-4, the explosive benchmark, roars out at an incredible 26,600 feet per second. The additional speed between commercial dynamite at 19,000 fps and C-4 is what cuts steel and shatters concrete. One is for homeowners, the other for survivors.

Recounting, to make C-4:

1. Use fresh NH_4NO_3 .
2. Dry the NH_4NO_3 in an oven at low heat (less than 150°F) for three hours or more.
3. Wash the NH_4NO_3 in alcohol until the alcohol turns muddy brown.
4. Dump the prill in a metal container and dry them thoroughly over low heat (less than 150°F).
5. Grind the NH_4NO_3 as fine as talcum powder.
6. Pack a premeasured amount in a rigid airtight container.
7. Pour in one-third nitromethane by volume.
8. Wait twenty minutes.
9. Shoot with a cap similar to dynamite.

Building and Keeping Your Arsenal Secure

It is important that all of the steps be undertaken carefully and methodically, and

that one experiments before going out in the field with military objectives in mind.

CHAPTER 25

THE FINISHED PRODUCT

We stood back about 90 yards from the small 11-ounce dab of explosive as the fuze slowly burnt its way down to the cap. In our experience, 90 yards was more than sufficient to protect us from such a small amount of explosive.

My many failed experiments with this material had left me uncertain as to whether we had anything more than another dud. The mountain meadow behind my cabin was strewn with ruptured plastic containers, left by dynamite caps that failed to detonate the explosives.

This time when the detonation hit, it was spectacular. A successful blast at last! The last time I experienced anything similar, I was firing LAW rockets at Fort Benning, Georgia. I vividly remember when the concussion from the three-pound warhead thumped us, even at 200 meters. I also remember a similar reaction while running through the army's live-fire tank-commander school south of Boise, Idaho.

Although I lacked sophisticated test equipment to measure its impact, the explosion undoubtedly had sufficient brisance to cut steel and shatter reinforced concrete. Several observers with military experience agreed that the homemade C-4 was formidable.

The afterglow from my original success kept me going when my next few attempts turned out to be duds because my ammonium nitrate had become water-soaked. I blew my materials budget, but eventually the results became consistent. The process produces the following reaction:

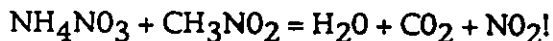

As a practical explosive, this material seems ideal. Two shots fired from a high-power rifle do not tell the entire story, but smacking the explosive with my .223 at 45 yards did not produce a detonation. To further test its sensitivity, I set a batch aside for a week. Then I threw it down a rocky ledge and later burned it on a bed of logs without any apparent effect. Even the burning itself was not particularly notable.

This explosive is remarkably similar to genuine C-4—particularly in its stability—but it lacks one of C-4's more desirable attributes. The brisance of this improvised C-4 was not as great as that of the genuine article. It wasn't off much, but the last 5,000 fps might mean the difference between a good and an excellent explosive. Boosting this material into the C-4 class became my goal once the secret of consistent manufacture was in hand.

The tip-off to a possible solution came while I was researching World War I's Messines Ridge sapper attack. Messines Ridge was the only actual trench-warfare offensive sapper action during a war that was fought almost entirely as a set-piece contest. After 18 months of preparation, the nine tunnels filled with almost one million pounds of explosives were detonated on June 7, 1917. The resulting blast was heard by British Prime Minister David Lloyd George from his home in London 200 miles away.

Britain's World War I explosives manufac-

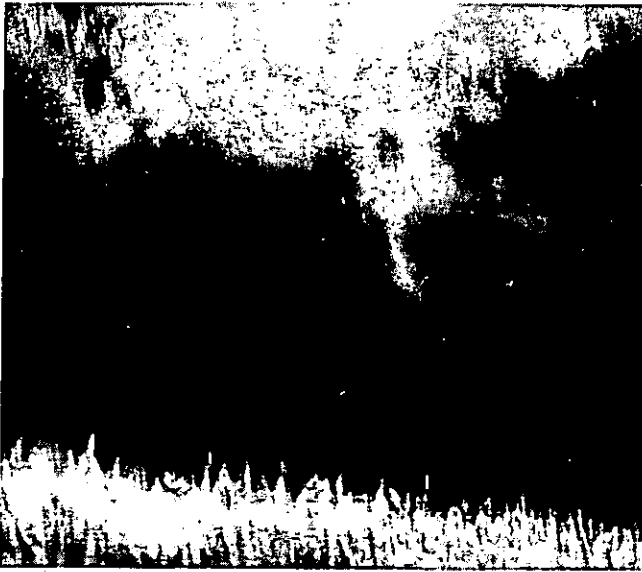

Detonation of 11 ounces of the homemade C-4 produces an impressive explosion. Experienced powder monkeys who witnessed the explosion agreed that this material is much faster than commercially available explosives.

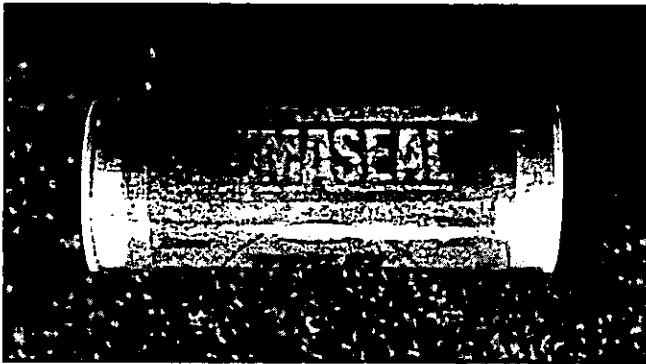

The detonation speed of the homemade C-4 is about 21,000 feet per second (fps), much faster than commercial dynamite but slower than TNT. The addition of finely powdered aluminum will boost the detonation speed nearer to that of genuine C-4.

turers added finely ground aluminum powder to this explosive, called ammonal, to boost its brisance. Ammonal was used because two years of protracted warfare had consumed virtually all of Britain's conventional explosives. It was manufactured using 72 percent ammonium nitrate, 12 percent TNT, and 16 percent finely ground aluminum powder.

Having made that discovery, I began to experiment with powdered aluminum. I added it to the ground ammonium nitrate before adding



Quickly and thoroughly mix the powdered aluminum into the aluminum nitrate prill before adding the liquid nitromethane.

the nitromethane. At a level of about 5 percent (or about 20 grams) mixed thoroughly into 430 grams of NH_4NO_3 , the effect was dramatic. Instead of seven-inch holes in the earth, I was gouging out nine-inch craters with less than three-fourths of a pound of explosive! Fine-ground aluminum powder is available from well-stocked paint stores and chemical supply houses, but the best place to buy it is from an automotive-parts shop. It is used to plug leaky radiators and is sold in 21-gram tubes.

Some aluminum powder is too coarse to enter into the detonation reaction. But most samples are finely ground and, for the price, work quite well (about \$13.85 per pound). Purists can obtain very finely ground aluminum flakes from chemical supply houses if use of this relatively expensive (from \$30 to \$40 per pound) material seems warranted.

Theoretically, it would be advantageous to pack the explosive in small plastic bags that could be molded around a piece of steel or other object that one wished to cut. What scant printed information is available on this explosive suggests that the material should remain undisturbed and unmixed after the addition of the nitromethane.

Building and Keeping Your Arsenal Secure

Without careful, controlled testing, we do not know if the combined materials become dangerously sensitive after mixing. So as a precaution, take to the blast site carefully premeasured amounts of aluminum powder in small sealed tubes and similar containers of premeasured nitromethane to pour into the powder. Inserting the cap and placing the charge should take about twenty minutes, and

the charge should then be ready to do its work.

Although this process is not unduly threatening to those who have handled explosives, it is an exacting and mostly untested one. Those who do not carefully follow all instructions should expect dangerous or poor results. Those who proceed with intelligence, caution, and diligence can expect to produce an explosive that will make despots tremble in their boots.

CHAPTER 26

CONCLUSION

Other materials exist that can be combined with ammonium nitrate to produce high-grade explosives. Some quite powerful ones aren't as deliquescent as nitromethane, giving the impression that they might be more desirable than nitromethane. One formula that is currently making the rounds among survivors involves mixing two parts of NH_4NO_3 with one part hydrazine. The resulting liquids reportedly make up the most powerful chemical explosive known to man—short of an actual atomic reaction.

An almost insurmountable problem with this explosive is the fact that anhydrous hydrazine is extremely corrosive and therefore desperately difficult to handle. It will blister an animal's lungs with just one diluted whiff. Professional industrial chemists use moon suits, respirators, and supplemental air supplies and still are very reluctant to do any more than a minimum amount of work with this chemical. Eventually it will eat through virtually anything metallic, making it almost impossible for survivors to store it at home. Unvented hydrazine fumes kill very cruelly in a matter of seconds.

As a result, the material is almost impossible to ship. Most carriers justifiably do not want to handle it, and partly as a result, it is also extremely expensive to purchase. It usually costs about \$100 per pound, but that does not include shipping. Furthermore, it cannot be sent by United Parcel Service, Federal

Express, or parcel post. So home chemists must drive hundreds of miles to pick it up personally or pay trucking charges of up to \$25 or more per shipment.

It is quite possible that three pounds of finished explosive using hydrazine could cost \$150 or more. When combined, the resulting liquid is extremely corrosive, toxic, and shock-sensitive. I know of no storage container that would hold the material. It can't be metallic and, if a glass jar ever broke or spilled, cleanup might assume catastrophic proportions.

As a result, it doesn't take a Phi Beta Kappa in chemistry to conclude that the ammonium nitrate/nitromethane mixture is superior for survivors' purposes—despite a slightly diminished brisance. In addition, hydrazine products require the use of sophisticated laboratory equipment not usually available to survivors. Buying this equipment could make the overall cost of the project prohibitively expensive for most budgets.

For the process recommended in these pages, one needs only common household items: a set of ovenproof glass dishes; a standard measuring cup; a standard probe thermometer; a coffee grinder; an electric wok; and a tea sieve. There is no need for extra-large glass beakers to handle the reacting chemicals, lab-accurate stainless thermometers, ice baths, air-evacuation equipment, or moon suits and respirators.

After nitromethane and ammonium nitrate

are combined, the mixture is reasonably safe and can be handled by most people, whereas hydrazine is too unstable to carry around or combine at the job site. Fumes from the reaction could poison everything downwind for several hundred meters. It also might arouse people's suspicions to see survivors running around in moon suits and respirators.

Other formulas for making C-4 substitutes abound, such as mixing pure nitric acid with glycerin to yield nitroglycerine. Nitric acid is obtainable and can be handled by amateur chemists, but it is somewhat risky.

Homemade nitroglycerine must be washed and purified to an extent that taxes the skills of sometimes chemists. Impure nitroglycerine grows increasingly sensitive on the shelf until simply moving the container could cause premature detonation. After my reading through detailed manufacturing instructions, it was easy to conclude that this process is unnecessarily difficult and dangerous.

In summary, the explosive made by mixing ammonium nitrate with nitromethane seems to possess all of the desirable characteristics of high-grade military explosives that are otherwise unavailable to survivors. The process has few disadvantages that I have been able to identify.

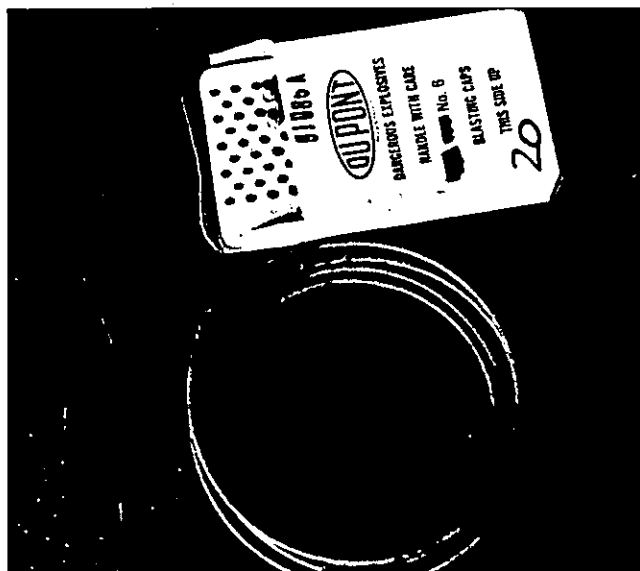

People unfamiliar with commercial explosives should not attempt to make C-4 at home. Use standard commercial caps to detonate the charge.

Note: Readers will note that throughout this discussion I have assumed the use of commercial safety fuze and caps or standard electrically fired dynamite caps. This book assumes that makers already know enough about explosives to know where to purchase the necessary caps and fuze.

CHAPTER 27

BACKGROUND

Arles is located in southeast France on the west bank of the Rhone River about twenty miles inland from the Mediterranean coast. It is located in Bouches-du-Rhone Provence in France. Few people today attribute strategic importance to the place.

Residents there learned early on to resist their enemies fiercely, but, when the time came, to throw in the towel quickly, as appropriate when facing insurmountable odds. Because of its proud, independent, wealthy inhabitants, armies from the city-states in Spain, Italy, and even from the French monarchy took any opportunity they could to occupy Arles so they could tax its wealthy merchants.

Ever-present antagonism from jealous neighbors—along with commerce and travel—tends to produce a class of people who are usually first in their area to know of any weapons innovations, and traders' wealth creates opportunities to purchase this new technology for the defense of their land. Entrepreneurial people generally have both the wealth and ambition to survive.

All this notwithstanding, citizens and mercenaries defending Arles watched in horror as soldiers of the king formed up around their walls in late April 1536 A.D. Obviously no crops would be raised on the common, and little trading would be done that year.

However, there was cause for hope for the people of Arles. Rather than simply perching stoically behind their rock walls, the defenders

had a new secret weapon. Traditionally, cauldrons of hot water and oil were placed on the wall to be poured on the hapless attackers below. Piles and piles of man-killing boulders stored in wicker baskets were hoisted to the catwalks. Battle axes and lances were distributed to those too poor to afford their own weapons. But this time, the defenders also received a new weapon that invigorated and enthused their efforts.

During the last few years traders from Spain provided Arles merchants with a dirt-brown, vile-smelling powder that, when exposed to an open flame, hissed and flashed in a "most hideous manner." Quantities of the powder burned rapidly, producing copious smoke and a loud thump if contained in a clay jar or skin pouch. Traders claimed firsthand knowledge that the material could be beneficial in fighting an enemy, such as throwing rocks on him, scaring his horses, or even burning him badly.

At great cost the men of Arles secured their first sample of the powder from the surly, difficult Arab traders who traded in their bazaar. Eventually, they learned that by mixing two parts of willow charcoal with six parts saltpeter and one part quick sulfur, they could manufacture their own ignis volans. Monks perfected the mixture on the condition that it be used to fight only infidels. It was amazing how rapidly this classification of person changed under duress.

Sulfur for the powder came from a mine in Spain. Willow charcoal was easily manufactured from the many trees along the Rhone. Producing saltpeter from water leached through baskets of chicken manure proved to be little problem to the budding chemists.

At first, the defenders intended to use their secret weapon to shoot rocketlike devices into the enemy's ranks. They tried this but had only limited success at the cost of great consumption of precious brown powder. At the encouragement of the professional soldiers, local boys secured some of the material to play with. A few capsulized the primitive powder in clay pots and began to throw it around with a slow match attached for sport. After two small girls were hurt in an incident, local military planners concluded that perhaps the boys might have stumbled onto something.

Dense, white clay was brought in from riverbank cuts 50 miles upstream. Potters shaped the clay into thick-walled, loaf-shaped receptacles having a hollow inner chamber. A small access hole allowed the device to be filled with small stones mixed with powder. Loaded, the bombs weighed between 3 1/2 and 5 pounds. Some shattered when tossed from the wall, but most remained intact, bursting nicely when the attached slow match smoldered into the powder.

When used in large numbers, the device seemed ideal to discourage attackers from taking up offensive positions in the ditch below the wall. Some of the devices detonated prematurely in the hands of the users; others failed to go off or were thrown back by the attackers. These grenades were far from perfect, but they worked well on at-

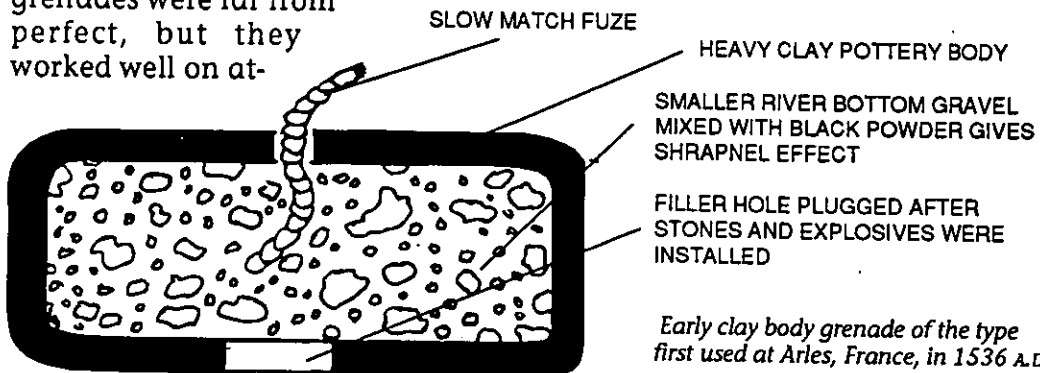

Early clay body grenade of the type first used at Arles, France, in 1536 A.D.

tackers who had never experienced anything like them before.

For days on end the king's men bravely stormed Arles' walls only to be repulsed repeatedly by the defenders using the hellish devices. Some of the attacking soldiers developed severe infections from the strange wounds they suffered below the wall. When fall rains came, the king took his thin, tired little army and headed back to Lyons. Arles was delivered, and the action became what historians note as the first "effective" use of hand grenades.

One can question the use of the word "effective" and, of course, whether this was actually the first use of hand grenades. Even as early as the seventh century A.D., Greek Byzantine and Arab armies used a mixture of tallow, pitch, and sulfur to produce a material that contemporary commentators claimed would burn under water. Questions of subsurface combustion notwithstanding, the material was effective when used against any type of fortification composed of combustible material. Europeans called the incendiary mixture "Greek fire," or in some cases "Byzantine fire."

Even 700 years later at Arles, it is difficult to imagine the tough circumstances under which a grenade thrower of that era must have operated. Fuzes were obstinate and uncertain. Even when the device landed near an enemy and went off on schedule, it often was ineffective. Damp weather often killed the explosives in the grenade and, at Arles, the defenders even ran low on suitable pebbles to put in the bombs.

During the remainder of the sixteenth century and on into the seventeenth, relatively great strides were made by designers of hand grenades. By the start of the seventeenth century, European armies commonly

Building and Keeping Your Arsenal Secure

Early cast-iron grenade used by grenadiers.

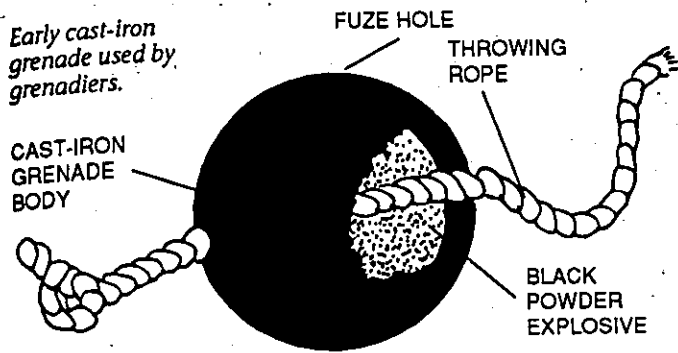

used hand-delivered explosive devices made of rough case iron or, in some cases, brass. The finished product was more like a bomb as opposed to today's traditional small, light, easily thrown hand grenades. Some of these first grenades weighed up to 18 pounds fully loaded. The cast-iron shell produced some shrapnel effect, but not nearly to the extent of modern hand grenades containing high explosives.

Obviously such a monstrosity worked best when dropped from a wall or when rolled into a fortification. Horizontal throwing distances were a short, putlike 20 to 30 feet. Fortunately the powder was fairly wimpy, or the device could have endangered its delivery system.

Perhaps because of their proximity to Arles, Spanish military armorers did most of the early development work on hand grenades. Their designs looked much like pomegranates, which in Spanish are called "granadas." Naturally the explosive devices soon became known as granadas and ultimately grenades. It wasn't much of a leap to grenadiers, soldiers whose job it was to throw metal powder-filled pomegranates.

Grenadiers, with their distinctive uniforms and special hats, became the elite soldiers of Europe during the seventeenth and eighteenth centuries. Grenadiers marched to war carrying large battle axes that they used to hack through walls and fortifications, allowing better placement of the grenades. Black powder became slightly more powerful and light years ahead in consistency. Fuzes also were made a bit more reliable, but that being accomplished, hand grenades again evolved at a turtlelike

pace. Many grenades of the era were designed to be thrown by means of a short rope tail.

Grenadier companies were useful as long as wars were fought from fixed emplacements. Use of hand grenades faded from the scene in lock-step with castles, moats, and siege warfare in general. By the middle of the nineteenth century, hand grenades were seldom used except in strictly defensive positions. When they were deployed, soldiers improvised by throwing out 3- and 6-pound howitzer projectiles. Customarily, these rounds were fuzed when the piece was fired. They were really nothing more than simple fuzed bombs lit and propelled by hand rather than a propellant charge.

A British armorer writing in 1887 said of grenades that "they are used chiefly for the defence of places against assault, being thrown by hand for 20 or 30 meters. However, hand grenades are now rarely demanded. When men are using them, they should be cautioned not to retain the grenade too long in their hands." This is probably the origin of the term "military intelligence."

After languishing in obscurity for 150 years, hand grenades leapt back into popularity again during the Russo-Japanese War of 1904. As a result, the world's armies again took note of hand grenades till today any frontline unit can be expected to use them in large numbers.

Many of the exact details are lost in the fog of history, but apparently an especially ambitious Japanese soldier grew tired of sitting in his foxhole at Port Arthur within a stone's throw of the Russian army. He whiled his days away concocting lethal firecrackers to drop on the Russians' heads. By using newer high explosives such as TNT and picric acid, he was able to inflict some very real damage. Better explosives allowed him to decrease the weight of his device to between one and two pounds. Instead of inaccurately lobbing the grenade a relatively short distance, the Japanese GI was able to accurately deliver the bombs out to one hundred feet or more, killing or maiming the Russian enemy.

Given the fact that the Japanese were the

masters of modern hand grenade technology, it is not surprising to learn that they perfected tactics to accompany their weapons.

Literally millions and millions of hand grenades were manufactured and expended during World War I. With the advent of commonly available, lighter, more powerful high explosives, grenades were easier to use, more accurate, and more lethal at greater range.

All this did not happen overnight. When Australian and New Zealand troops landed on Gallipoli in 1915, there were so few hand grenades available that the soldiers immediately set to work making their own. They used old beef tins, jam jars, and canteens to make portable bombs. Most were capped and fuzed, similar to common commercial explosives. Gamely, these men threw their bombs uphill at the Turks, who simply stood aside allowing the ordnance to roll back downhill onto the original owners.

Although the men on Gallipoli never profited from it, help was on the way. In the United Kingdom, William Mills invented and patented a hand grenade that even 65 years later would look familiar to the average GI. His patent, issued on September 16, 1915, was for a cast-iron device with segmented body and an internal cap that activated a 4-second fuze. The fuze was lit when the pin was pulled, allowing a retaining spoon to fly away, which thus dropped a striker.

By the end of 1915, 800,000 were being produced per week in the United Kingdom. "Grenade Hand No. 5," as this Mills bomb was called, stayed in production till the end of the war. More than 33 million were eventually manufactured and thrown at the Germans.

In mid-1916 a variation of the Mills bomb, called the "Grenade, Hand or Rifle, No. 23," came on the scene. This design took advantage of better, faster manufacturing tech-

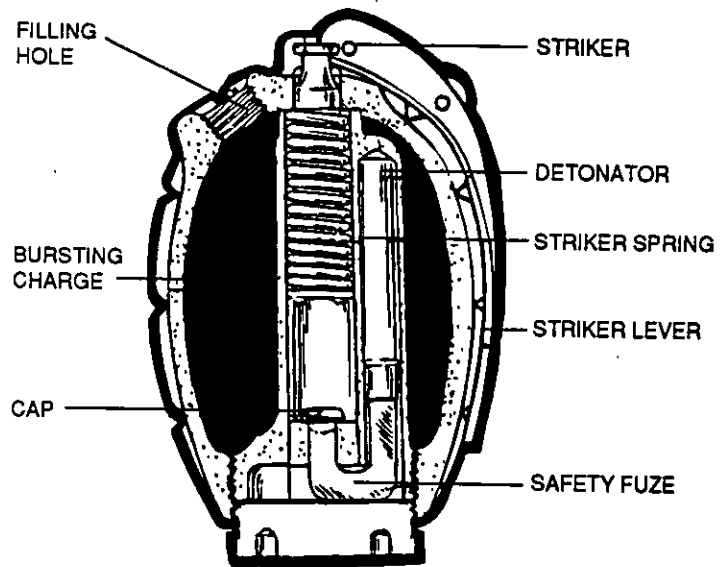
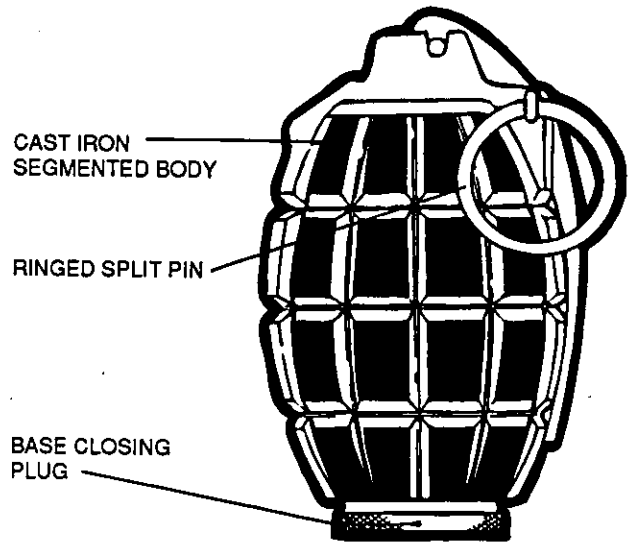

Developed in 1915, the Mills number 5 hand grenade, better known as the Mills bomb, was the first modern British grenade.

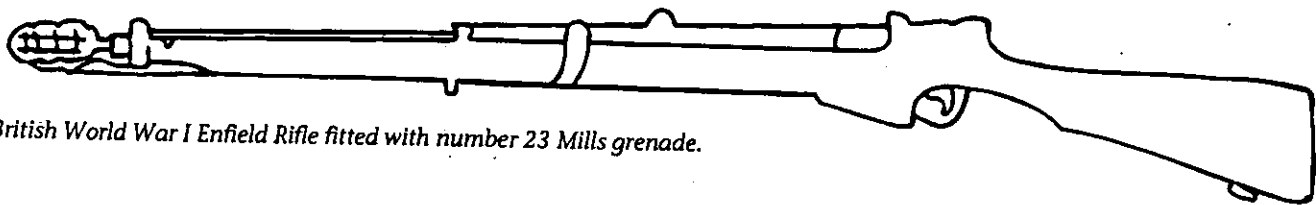

British World War I Enfield Rifle fitted with number 23 Mills grenade.

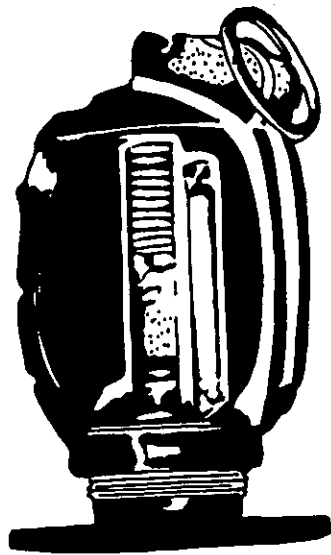

Mills number 36 grenade with the gas check plate that allowed it to be fired from a rifle discharge cup.

niques, making it cheaper to produce and slightly more powerful than its predecessors. However, its principal advantage was the fact that the grenade could be either rifle-propelled or hand-delivered. Europeans did not go further and attempt to create a bomb similar to the Japanese grenade that could function as a

hand grenade, rifle grenade, or mortar bomb.

Rifle grenades had been used in medieval Europe as well. In the seventeenth and eighteenth centuries, grenadiers were often called on to shoot their grenades into the opposing ranks. Usually they used a standard-issue musket, the grenade being held in an iron frame attached to a rod that was dropped down the barrel of the musket. Given the fact that grenadiers had been a major offensive force for more than two hundred years and before disappearing they became light artillery, it is not surprising that the English put a high priority on rifle grenades.

More than 29 million of the new, improved rifle-adaptable Model 36 Mills bombs were used during World War I. As the war ground on, additional small changes were made in the Model 36's design, allowing for even faster, cheaper manufacture of a more reliable product. One significant change

entailed producing a grenade that would not deteriorate in hot, humid climates. This grenade was designated a Model 36M. "M" in this case stood for "Mesopotamia," which apparently exemplified a hot, humid, difficult place to the English.

The function of the pineapple serrations cast into the body of the Mills grenade was the subject of heated discussions during the 1920s. Not until the advent of spark photography and telephoto lenses did debate give way to certain knowledge. High-speed photos showed that the grenade shattered at random rather than along the serrations. Later, the inventor asserted that the serrations actually assisted the user, who was often forced to lob the device with muddy, slick hands.

German armorers certainly were not oblivious to developments during the Russo-Japanese War. However, they chose to take a simpler, more direct approach that for a time confused Western armorers.

At the start of both world wars, the Germans used stick grenades. With practice, stick grenades can be thrown farther, more easily and accurately, and they are definitely cheaper and easier to manufacture. German stick grenades were little more than a small tin canister of high explosives attached to a hollow wooden handle. U.S. and British GIs referred to them as potato mashers.

Inside the wooden handle, a string attached to a friction device lighted a short fuze when pulled. Stick grenades generally provided the user with four to five seconds before one must

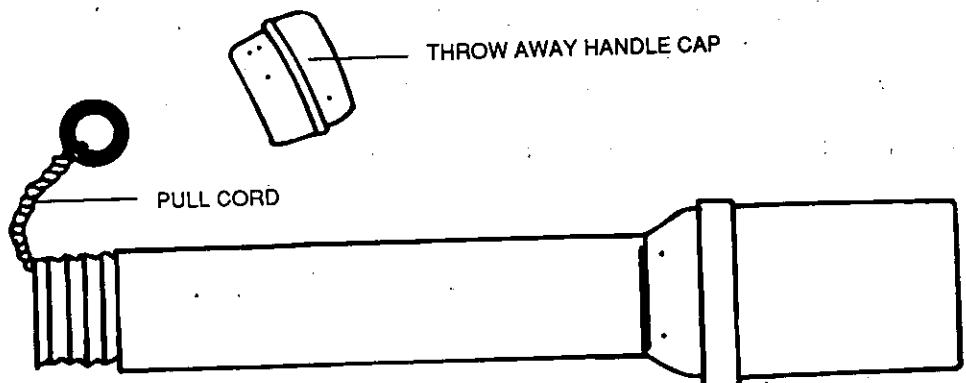

German World War II stick grenade.

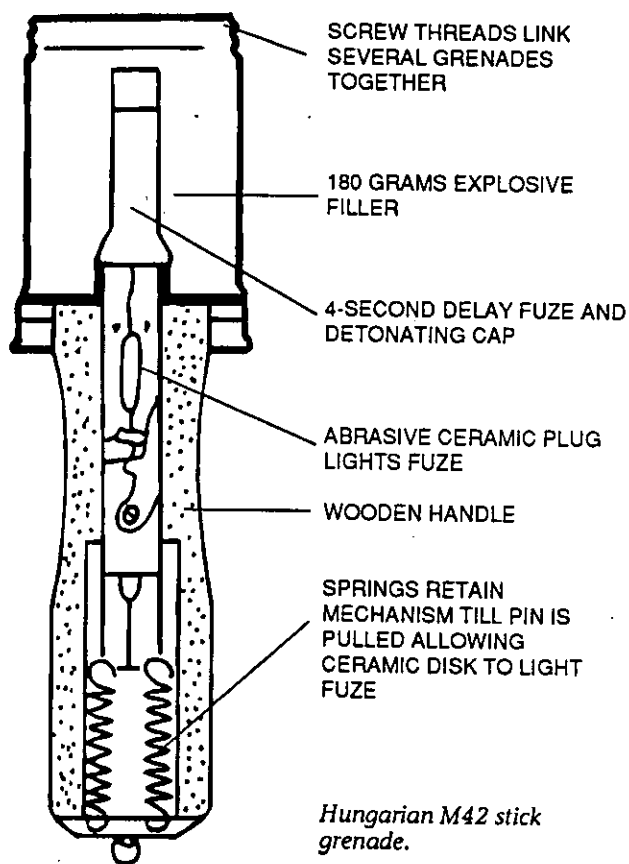

present it to the new owner. Tying a string to an abrasive ball that scratched a match not only was simpler and cheaper than a mouse-trap design, the grenade was also stealthier, as the recipient could not easily hear the audible pop of the cap starting the fuze.

British armorers developed a similar-looking device in 1908. But the British grenade had an impact-detonating cap rather than a delayed-action fuze. If the user threw the grenade so that it landed on its knob and detonated, and if the user didn't strike it on the side of the trench accidentally, all was well. British soldiers who reared back to throw the 1908 model had extremely short lives.

Some two million British point-detonating stick grenades were made before the generals noted a reduction in ranks because of sloppy backhanding. However, one must not conclude that the stick design was the problem since many other nations, including China,

Japan, Italy, Czechoslovakia, Hungary, and the Soviet Union, all came out with similar fuze-light stick grenade designs. (Survivors may wish to make their own stick grenades. Instructions follow in Chapter 28.)

Hungary has the distinction of being the only country in the world currently manufacturing modern stick grenades. Hungarian armorers designate their device as an M-42. M-42s are unique in that several devices can be locked together to form a single, more potent demolition charge.

Chinese stick grenades are still encountered from time to time throughout the world, principally because millions upon millions were manufactured and exported. Until the last of these is actually thrown at someone they will probably keep turning up from time to time. Common designations that may be encountered include the Type 42, Type 33 (which is really not a stick grenade, but rather one having an unusually long fuze handle), and a venerable old war horse called the Type 1.

These designs are almost identical to obsolete Soviet models. Because nothing, especially armaments, are ever thrown out in socialist armies, one may encounter all sorts of odd, obsolete hand grenades.

As of this writing, virtually every country in the world uses some sort of egg grenade with a flip-spoon, detonating-cap, fuze-lighting system. Hand grenades as we know them were perfected during World War II. Basic egg designs won out over all others because of their effectiveness in actual field use. No accurate estimates are available regarding the number produced and expended, but some guesses run as high as half a billion.

Trends today are definitely toward smaller, lighter, more easily thrown models, and most no longer are manufactured with cast-iron bodies. Modern grenades adhere closely to the design of the U.S. M-61. Bodies of the M-61 are manufactured of thin steel sheeting containing a component material that capsulizes a tightly coiled spring. The spring in this case is precision-notched so that it will blow apart in precisely predetermined segments. Each seg-

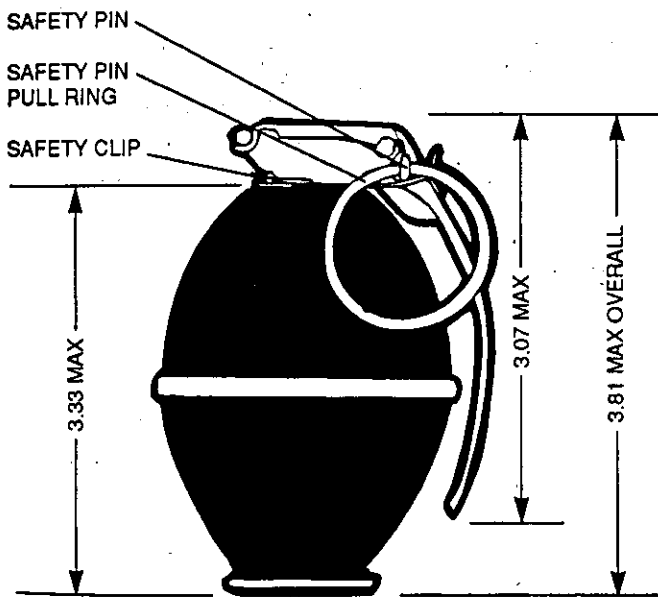
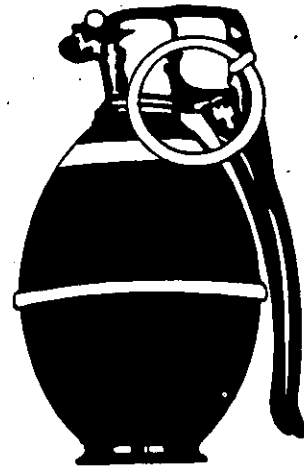
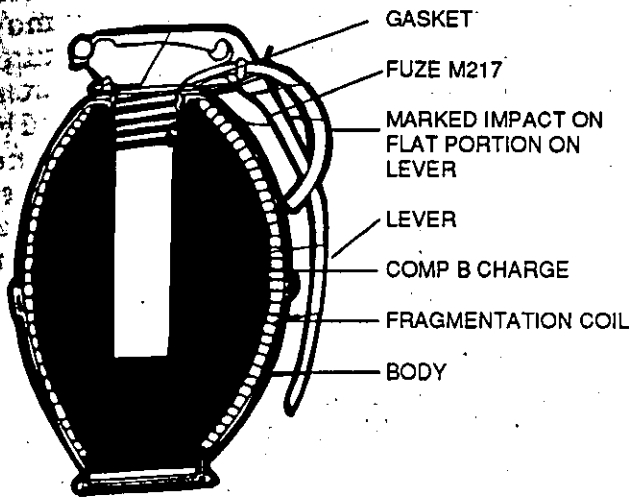

Standard-issue U.S. M61 delay-fragmentation hand grenade.

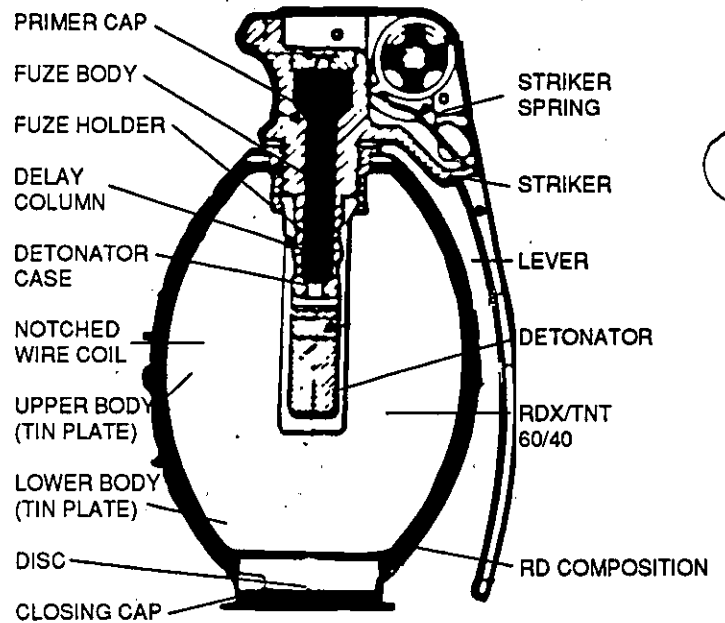

Current-issue British L2A2 antipersonnel hand grenade.

ment is calculated to do maximum possible damage. Modern grenades consistently detonate and produce casualties among those 5 meters or less from the blast.

All modern grenades have a mousetrap design used to pop a cap igniting a fuze after the grenade leaves the user's hand. (For survivors, these designs may be needlessly complex, but that is a matter of opinion. If authen-

ticity is one of your goals, you'll choose egg-shaped pull-pin grenades rather than cheaper, easier scratch models.)

By the end of the World War II, hand grenades, to an extent, had dropped into obscurity again. But this time the obscurity was different than during the late Middle Ages. This present-day lack of emphasis on grenades stems from the assumption that

everyone has them and everyone knows how to use them. Simple, easy-to-use, commonly available hand grenades are among the everyday working tools of the average grunt. Only a few hours are spent on grenades during basic training. After that, everyone is assumed to know how to use them. In that regard, they have become like helmets. No special emphasis is given to them.

Any future improvements in hand gre-

nades, if any, will be related to the increases in power of the explosive filler. Fuzes may become simpler and easier to manufacture, and the fragmentation body may benefit from better design. All this will undoubtedly lead to a world where tens of millions of hand grenades are pumped out by giant machines that produce them for a few cents each. In the meantime, survivors will find them easy to make and fun to play around with.

CHAPTER 28

USE OF HOMEBUILT HAND GRENADES

As with construction of virtually all of the large-bore ordnance described in this book, making hand grenades is both very dangerous and very illegal. Only those who are cautiously comfortable around military and commercial explosives should even consider fooling around with devices described herein.

However, hand-grenade outlines in the following chapters contain a number of unique safety features that even military models don't have. Detonating devices can be installed at virtually the last moment before use, and explosives are binary mixtures as safe as any explosive can possibly be. Nevertheless, careless, foolish, or ignorant makers can easily blow themselves off the face of the Earth.

Perhaps hand grenades are illegal in part because they are effective as well as cheap and easy to manufacture. Given these attributes, it is little wonder that politicians are fearful of them. Politicians and especially bureaucrats do not seem to want independent-minded people running around with these little, easily concealed destructive devices.

One of the most pervasive problems that hand-grenade makers must face is that of finding suitable military-grade explosives. Until recently, this roadblock has been virtually insurmountable. Black powder often will not detonate with sufficient enthusiasm to rupture even the cast-iron tube of the device, much less send shrapnel out in a lethal pattern. A combination of commercial 40-percent

dynamite and homemade chlorate powder mixed with Vaseline is similarly lacking in explosive thump.

Sixty- and 80-percent commercial dynamite is also borderline in my opinion. What is needed is a superfast, military-grade C-4-like filler. Binary C-4, as outlined in Part 5, is ideal. I guarantee the average survivor will be pleased with the results. As an added benefit, users need not create the explosive until shortly before the exact time of need, perhaps only after the trigger mechanism is safely secured in place.

Possession of the homemade C-4 secret is an incredible advantage in many regards for the home builder of all explosives ordnance. It is difficult to overemphasize the power this knowledge places in the hands of any average citizen.

James Poden, a close friend and exchange worker when I was still on the farm in my early adulthood, was old enough that he was awarded an all-expense-paid excursion to the South Pacific, courtesy of Uncle Sam. Because Jim was a much-experienced midwest coon and possum hunter, familiar with and unafraid of the night, he was often asked to lead three-man patrols into no-man's-land to act as company scout or to take the most forward listening post when his outfit was on line.

Poden often explained to us that the enemy tried to infiltrate their line almost every unusually dark night. When they did so, he put his rifle aside, using either his pistol as a last

resort or preferably copious numbers of grenades. Firearms, he said, betrayed his position, creating a volley of instantly well-aimed return fire.

Every time he fired his rifle, he quickly discovered, his approximate location and—more important—his presence were instantly known to the enemy. From then on, he could expect random rifle fire, crawling infiltrators, and perhaps even a mortar round or two.

Hand grenades, on the other hand, lobbed out 100 feet ahead never betrayed his position, while effectively clearing the area of his skilled creeping antagonists. Poden built quite a reputation among his peers, both as an effective soldier and as one who kept everyone else awake at night with his random grenade discharges. Poden also claimed he was able to smell enemy soldiers as they advanced on him.

It is easy to envision similar situations wherein survivors desperately need high-powered, portable explosive devices. Survivors may even be in much the same circumstances as those in which Poden found himself. Hand grenades, deployed wisely, force the bad guys to keep their distance and can be deployed day or night. Production is relatively cheap and easy, especially if one uses scrounged bits and pieces to a great extent.

Average survivors should plan to lay back at least twenty to thirty grenades. This can be a most difficult endeavor if it costs more than \$8 to \$10 to construct each one. Scrounged components cost only the time it takes to find the pieces—often they end up being virtually free.

No matter what the cost, prudent survivors had best plan to pay it. Improvised, expedient booby traps are made a hundred times faster and easier when one has a ready supply of powerful grenades. No civilians and few military people will come tripping arbitrarily across one's property if they suspect that hand-grenade booby traps are present.

Often just a rumor of the presence of hand grenades is sufficient to keep unwanted visitors at a distance. Yet if the time actually

arrives to use them, they can be transported from one place to another easily and safely. They are useful for destroying bridges and walls, closing roads and trails, taking out large military-type vehicles, and cutting through emplacements and roadblocks. And as an added bonus, we can have great fun building and testing them. Use them in old car bodies, in water for fishing, and just to shake things up in the dark of night.

Now before the need arises, survivors should give serious consideration to locating ideal places from which hand grenades might be deployed. They should also formulate definite, hard-and-fast rules of engagement. It is too late after the Bad Guys start to advance. They may overrun your retreat while you hesitate, trying to decide if this is actually the time to deploy the arsenal.

Because the example grenade is more of a hand-delivered bomb than a light grenade, one could easily kill or maim oneself when it goes off. Users should develop places from which the bomb can be deployed safely (for the user).

These could include paths or roads along which intruders must travel to one's retreat and from which grenades could be rolled or dropped from sufficient distance to be safe for the user. Some discharge locations might be located in a convenient fold in the ground, behind a gentle rise, or in another similar location.

It is also important that makers experiment until they know the exact extent of the damage done by one or more of their devices. I would not, for instance, discharge one of these heavy models on flat ground where I threw it and count on the distance between it and me for protection. Should it be necessary to deploy a heavy grenade on flat ground, I would want at least 250 feet, a big tree, or a small hill separating me from the device.

Of course, one can construct smaller, kinder, and gentler grenades that can be thrown farther and which have a smaller blast radius. I do not care for them, as the detonators are more difficult to build and less reliable.

These little true hand grenades are triggered identically to their big brothers but con-

tain only about six ounces of C-4 instead of close to a pound in the big "2" model. I have found that as little as half a pound of our home-brewed C-4 gives the user a severe wind shock at 50 feet when shot out on the hard, dry ground. But big is still better in this case.

Because a cast-iron pipe will be shattered into hundreds of lethal shards, it is always best to assume the worst during a practice session and to back way off—even if the loading is relatively light. My favorite exercise is to throw grenades 50 feet downhill into a deep ravine. Shredded weeds, bits of bark, leaves, and brush are thrown about, but nothing more dangerous results from the blast.

If I have a misfire, I wait two days and then take two dry logs, carefully place them next to the device, throw a quart of kerosene on the whole mess, and light it. Never, under any circumstances, handle or attempt to disassemble a dud. Don't even move it or try to pick it up.

In summary, the rules of hand grenade deployment are simple. These devices are dangerous and illegal. They are also simple to make at home, and they are extremely effective. Develop a definite plan of action for their deployment and set off numerous practice rounds to learn how they work best before you must rely on them.

CHAPTER 29

HOME CONSTRUCTION OF HAND GRENADES

Given the fact that many survivors and large-bore military hobbyists will want a generous supply of hand grenades, they must make two basic decisions: how large a device to deploy and what type of fuze to use on the monster.

As a practical matter, 1 to 2 inches is maximum for a grenade. Anything bigger than 2-inch pipe is needlessly costly and difficult, as well as being far too large to carry, conceal, and deploy. Pipe larger than 2 inch, along with required fittings, is difficult to find in most plumbing supply houses. Five-inch hand grenades made from 1-inch pipe will load about 6 ounces of homemade C-4. That is enough to do incredible damage, especially inside a car or truck, closed military vehicle, or in a foxhole-type hiding place. Devices made with pipe smaller than one inch are tricky to fuze and may not be worth the effort in terms of firepower and reliability.

A 1 1/2-inch pipe 5 inches long contains about 9 ounces of explosive. Two-inch diameter pipe 5 inches long deploys a full pound of C-4. Anything bigger is simply too big to carry and use. Grenade bodies can be made longer (or shorter) than 5 inches, but again 5-inch sizes have proven most efficient in actual field trials.

Defensive users will get relatively few chances to use their hand grenades. This is another reason I favor bigger sizes that do the job the first time. Full-pound models work somewhat better against cars and trucks, as

well as personnel protected by ballistic shields and other devices. The downside is that the device cannot possibly be thrown far enough on level ground so as not to endanger unprotected users.

The next decision involves selection of the detonating assembly. Realistically there are two fuze designs that work for home grenades. Both start with the same 2-inch diameter by 5-inch long piece of common pipe. Many hundreds, if not thousands, of fuze types can be designed by clever builders. Those listed are ones that I have found to be simplest and most reliable—the two basic criteria for homemade grenade.

Proceed as follows: secure two solid end caps for the segment of pipe intended for the hand grenade body. Using 2-inch diameter pipe is much easier the first time around.

Securely screw one of the caps onto the pipe segment. Use a pipe wrench if necessary, but tighten the one cap on as permanently as possible. Using a steel straightedge, find the exact center of the second cap. Drill a 1/4-inch hole through cap number two.

Standard commercial dynamite fuze burns at rates from 2 to 4 seconds per inch. Test the fuze carefully by burning several short pieces. Time the burn rates accurately because this determines how long a fuze should be for a relatively safe hand grenade. If you find the rate to be from 2 to 4 seconds per inch, use 2 to 3 inches of fuze. Since recipients of the hand grenade are unlikely to realize what you are

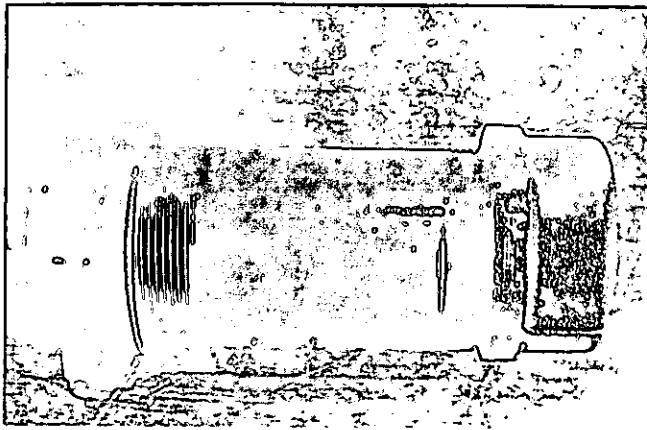

Hand grenades can be made out of 1-, 1 1/2-, and 2-inch pipe fittings. Basically, all that is required are a 5-inch nipple and two end caps. A 2-inch assembly is shown.



Carefully pack the pipe body full of washed, ground ammonium nitrate. Pack as tightly as possible. Leave a short section of dowel rod inserted in the packed powder as a removable cavity for the cap assembly. Seal up the plastic bag so that no moisture finds its way to the explosive.

doing till it is too late to lob it back, I favor longer fuzes. Long fuzes are not only safer, they differ very little from short fuzes in actual tactical results.

Military grenades vary in fuze time from 4 to 9 seconds. Longer fuze times are necessary when the grenades are fired from rifles or double as mortar bombs. Home manufacturers should strive for consistency rather than quick fuzes. That way, a user who is absolutely certain of burn time can hold his sputtering



Using a good, solid plastic bag and wooden stick, carefully line the pipe body with a plastic bag to keep moisture and air out of the sensitive powder.

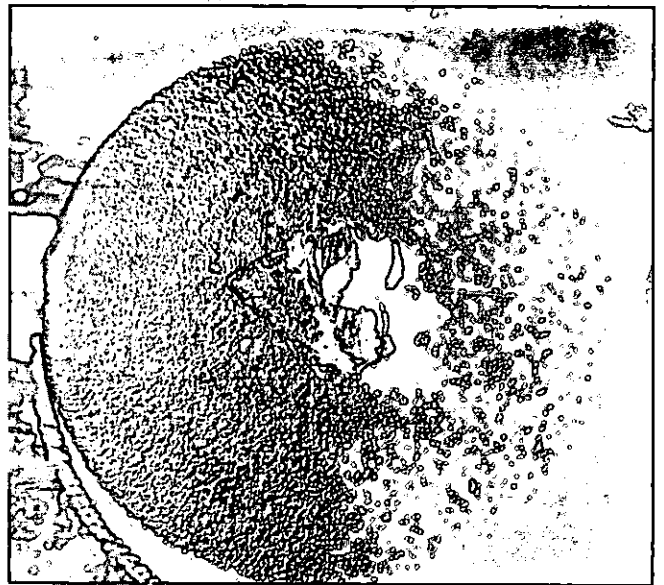

Find the exact center of the pipe caps, drill a 1/4-inch hole through the center, insert a piece of standard diameter fuze that will burn 12 seconds or more, split the fuze, and glue the split halves to the end cap body. Finally, glue the end of a strike-anywhere match tip into the fuze powder train with the strike-anywhere tip facing up. A standard number 6 cap is attached to the dynamite fuze leading down into the explosive.

Building and Keeping Your Arsenal Secure

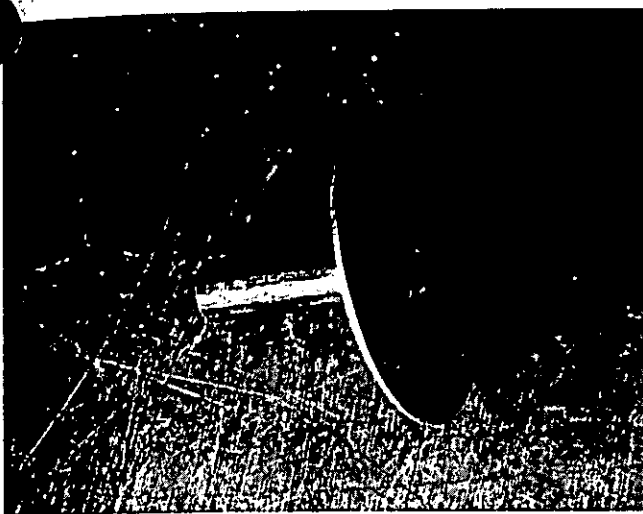

Prepare a pull-pin fuze by gluing or welding a 1/8-inch pipe nipple into the center of a 1/2-inch fender washer.

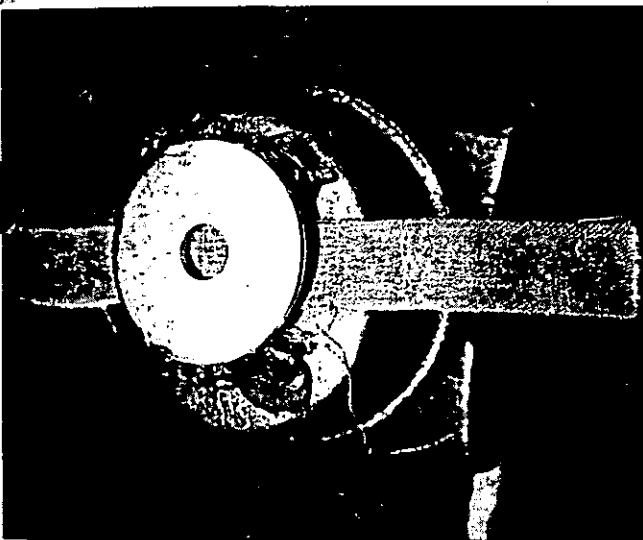

Lay a strip of coarse emery cloth on the match head and fuze assembly. Glue a 1/2-inch fender washer securely on top of the emery cloth and fuze to provide friction. When this emery cloth is pulled, it will light the match. If the match does not light, the fuze can be lit manually through the hole in the washer.

bomb an extra second or two till he is absolutely sure it is properly lit.

Cut fuze length as desired, but it should yield at least 12 to 15 seconds of delay. Push fuze through the 1/4-inch cap hole and split it in half with a razor blade, exposing its powder train core. The long tail of the fuze must extend down through the threaded portion of the cap.

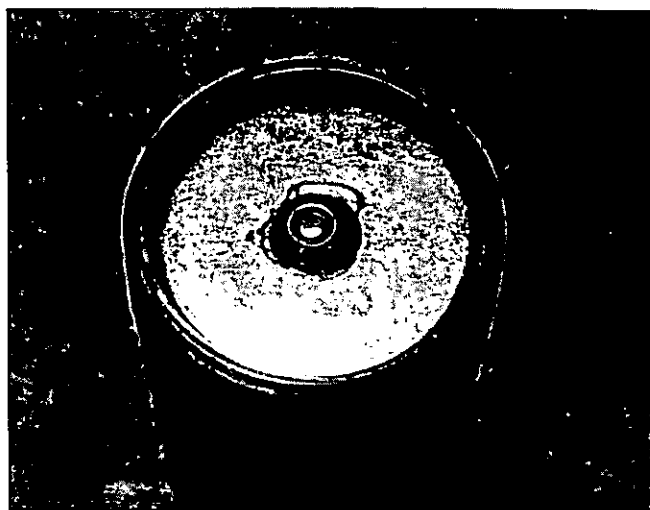

A standard magnum shot shell primer is placed inside the end of a 1/8-inch pipe nipple. This assembly is dropped 3/4 inch down into the grenade body, where it is securely fastened.

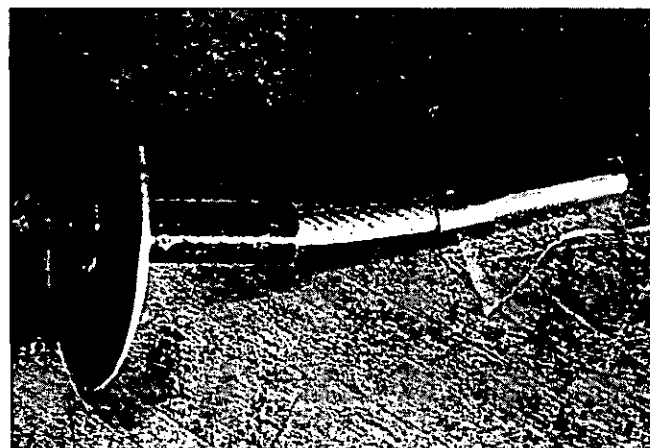

A fuze segment with cap attached pushed snugly up into a 1/8-inch pipe nipple with shot shell primer in place ready for insertion in the grenade body.

Use any thick adhesive, such as Goop or possibly even candle wax, to secure the split fuze to both the bottom and top of the cap. Do a thorough job, but do not slop the glue onto the exposed powder at the fuze's core. Allow this entire assembly to harden, holding the fuze rigidly in position. This may take two days.

After drying, securely and properly crimp a number 6 dynamite cap to the fuze end extend below the cap. No other protection is needed between fuze and explosive since homemade C-4 will not detonate from an open flame.

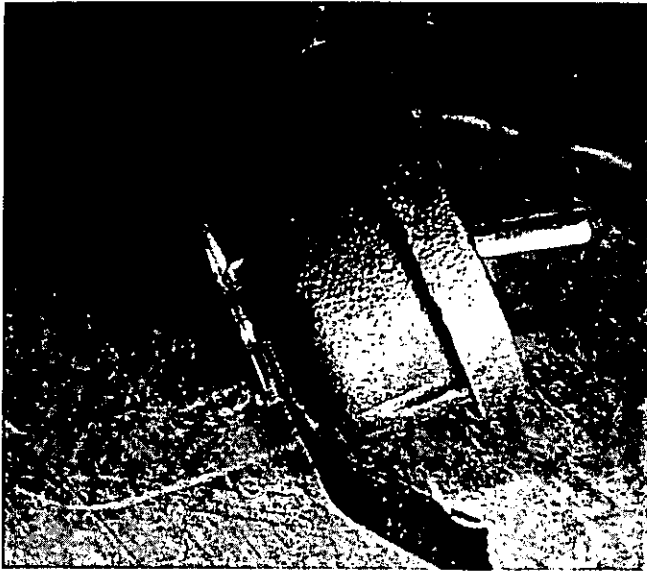

Side view of friction lighting assembly mounted on a 2-inch pipe cap. Dynamite cap on right is attached to a piece of fuze with a demonstrated 12-second burn time. The emery cloth on the left bears against match head set in the split ends of the fuze.

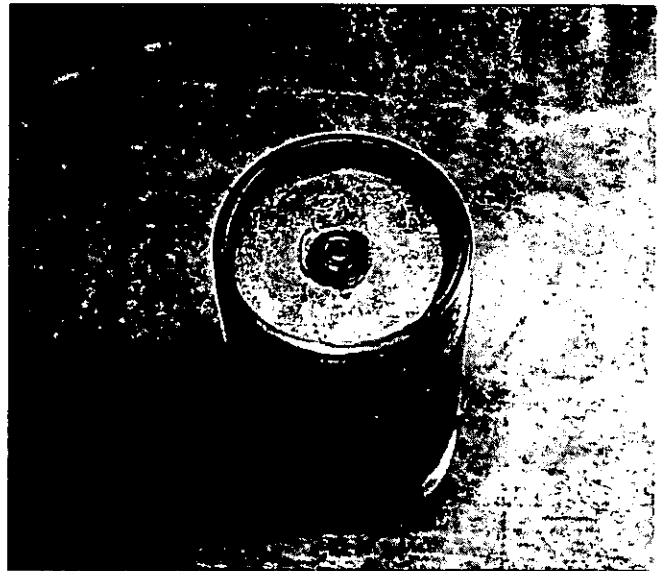

Pull-pin igniting assembly is set 5/8 inch into the body of a homemade grenade, and the powder is packed against this assembly from the other side into the grenade body.



Drill two opposing 3/16-inch holes on both sides of the grenade body. Install a safety pin through these holes so that it completely covers the shot shell primer igniting device, thereby preventing accidental detonation.

Because it is critically important that the hand grenade go off on schedule, I also cement (Duco is best) a 1-inch length of 50-gram primer cord to the lower cap body. Theoretically, homemade C-4 does not require this booster, but in actual practice it is wise insurance.

Using a blunt wooden stick similar to a tongue depressor, tamp a thin plastic bag into

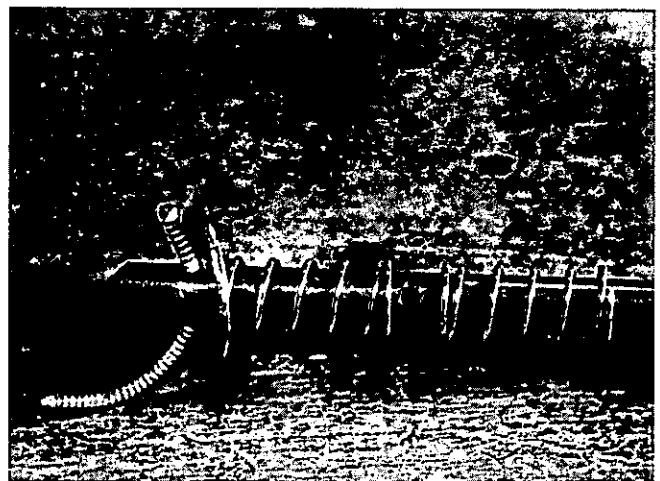

Sharpen the end of a 4-inch long, 1/4-inch bolt and drill a 1/16-inch hole through the bolt about 1/2 inch ahead of the sharpened tip through which a pin is inserted. This pin becomes the retainers for a flat washer against which a 3/8-inch compression spring bears, and a second 1/16-inch hole farther up the shaft acts as the striker retainer hole.

the body of the grenade. Make certain that you use a sound bag without holes and put it in place skintight inside the grenade body.

Insofar as is possible, keep crinkles in the bag at a minimum. Do not puncture the bag. This protective layer must keep the very deliquescent (moisture-absorbent), ground, and washed raw ammonium nitrate in stable, air-

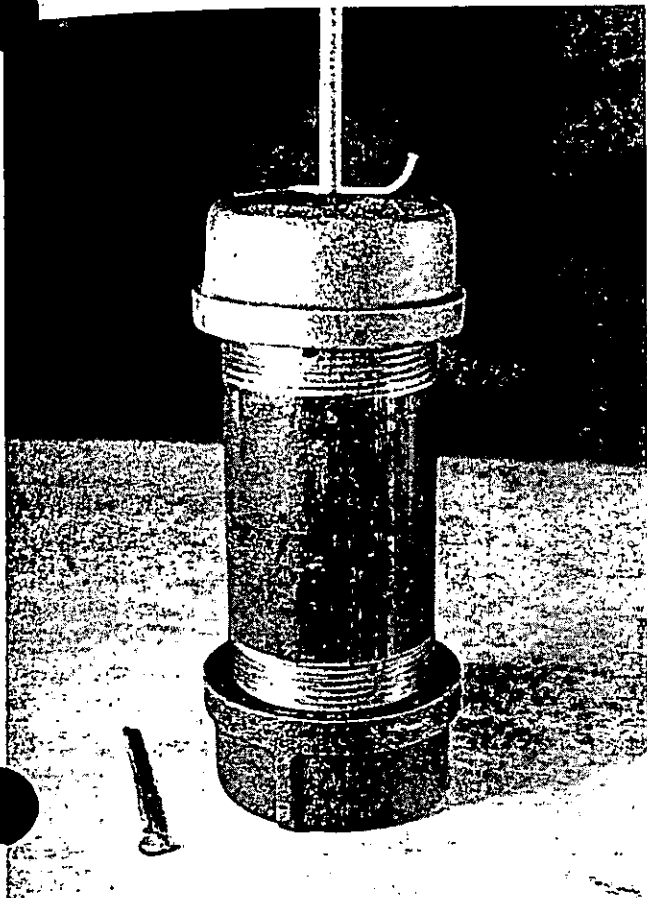

Firing-pin assembly cocked and retained with a small pin. Note the nail used as safety taken from hole in the grenade body, lying next to the grenade.

tight condition until pressed into service.

Painting the inside of the body with a good, thick-skinned, closely adhering paint is an alternate method of sealing the pipe while allowing for a few extra grams of explosive content.

After either painting or lining, begin to tamp the finely powdered ammonium nitrate into the grenade body. Use a wooden stick to layer the powder immediately after it is washed and ground. It is imperative that the powder be packed into the cast-iron pipe as tightly as possible and that the bag be free of tears. The builder must keep accurate track of the exact amount of ammonium nitrate powder used so that the correct amount of nitromethane can be measured. Store the correct charge of nitromethane in a tightly closed plastic pill bottle till the two are mixed.

At this time the grenade is not armed or dangerous. Push a wooden 1/2-inch dowel down into the powder to make sufficient space for the cap assembly. I also write a random three-digit number on the bottle of nitromethane and grenade body, ensuring that the correct predetermined amounts of chemicals eventually end up together.

When the body is full, leave the stub end of the dowel in place. Securely tie the top of the plastic bag shut, keeping out all air and moisture. Seal by capping with a third nonfuzed pipe cap till ready to deploy the device.

At show time, screw off the temporary cap, open the plastic bag, pull out the wooden dowel, dump in the bottle of premeasured nitromethane, screw in the fuze, and away you go. Theoretically, it takes 20 minutes for the chemicals to combine. Usually I combine the chemicals early in the morning before a practice shoot. The longest I have stored homemade activated C-4 in grenades is three days. I believe it probably could be kept in an alert state for two weeks if necessary. But, of course, this is seldom necessary.

Besides being much safer, mixing as close to the time of need as possible has another positive advantage. Until mixed, the device could not be classified as a destructive device since the fuze and cap would not detonate the ammonium nitrate. This could be an important legal point.

Returning to the manufacture of the trigger mechanism that was set back to dry, use highly flammable glue (such as contact or Duco cement) to lightly glue the head of a strike-anywhere match to the powder train. Be sure the lighter-colored strike-anywhere portion of the match head faces upward from its place affixed to the fuze powder train. Next construct an abrasive striker. Builders can use either throw-away emery boards similar to those used to manicure fingernails or strips of coarse 50- or 80-grit emery cloth (use cloth, not paper). Paper is not tough or supple enough for the job at hand.

As a rule, I use small emery boards if I can find them. They are more difficult to prepare,

but they also are slightly more reliable. When using emery boards, grind the grit from the side of the board with the finest abrasive, i.e., use the side of the board with the coarsest abrasive to scratch the match head.

Place the coarse side of the emery board down on the match head. If it is emery cloth, similarly lay the abrasive on the match head. Place a 1 3/4-inch diameter fender washer on the top of the board or emery cloth at the place where the abrasion contacts the match head. Using a big dollop of thick, viscous Goop-type glue or silicon caulk, secure the washer to the pipe cap in four places.

Do not press or otherwise mash these components together. The weight of the washer itself should provide sufficient friction to ignite the match head when the strip or board is pulled.

Should there be a misfire or failure of the fuze to ignite, users can light the fuze with a match through the hole in the washer. After lighting, hold the bomb a second or two till there is no question that the fuze is burning. There is no particular danger if one uses a longer fuze, 3 inches in length or more, providing approximately 12 seconds of burn time.

Hand grenades can be made to be lit with matches or a cigarette lighter. I do not consider this to be a viable working method, although such devices are much easier to construct. During the heat of an engagement it is often extremely difficult to get a lighter or match flame in contact with a fuze. Using a match will give one's position away at night unless the user is extremely cautious.

Many people like pin-activated hand grenades much better than the abrasive-fuze variety. Mousetrap designs are much more difficult to build and, in my opinion, much more dangerous.

Start this variant with the same basic 2-inch cast-iron pipe body and undrilled end caps. Purchase a 2-inch fender washer with 1/2-inch center hole. Also purchase a 5-inch long, 1/8-inch pipe nipple. This piece is cut in half, producing the two 2 1/2-inch fuze protectors required: one each for a pull-pin-type ignition system.

Using heavy glue or braze if available, fix

one-half of the 1/8-inch nipple to a 1/2-inch fender washer. These washers are almost 2 inches in diameter and fit nicely in the grenade body. Be sure the 1/8-inch nipple is centered. It will hold the shot shell primer.

Homemade C-4 will not detonate as a result of a sputtering fuze or hot match, but the nipple is necessary to support a detonation assembly. Detonation is accomplished using a magnum shot shell primer. Securely crimp or, if necessary, glue the primer into the top of the 1/8-inch half nipple fastened to the fender washer. Be sure no glue interferes with the hot end of the primer. Push a 3-inch (or more depending on one's predetermined fuze burn rate) piece of dynamite fuze securely up into the bottom of the 1/8-inch nipple so that a freshly cut end abuts smartly into the business end of the primer. Sufficient fuze should remain exposed at the bottom so that a number 6 cap can be affixed properly.

Crimp the nipple securely onto the body of the fuze. This crimp must be tight. If it cannot be crimped, glue or tape securely. The fuze must be held in place rigidly so that the force of the cap detonation does not push the cap away from the fuze, failing to envelop it in hot gases.

Place the completed, blued, crimped, fuzed nipple and cap assembly down onto the end of the grenade pipe body about three-quarters of an inch. Some adjustment will be necessary, but it is possible to adjust a bit by screwing the pipe caps in or out. Working from both ends and using heavy Goop glue, rigidly secure the washer inside the pipe body. Wait at least two days for the glue to dry.

Mark the center of one of the end caps, drilling a smooth, straight 1/4-inch hole therein. Slop the bit around a bit so that a 4-inch long, 1/4-inch bolt will slide through the hole in a vertical position.

Drill a 3/16-inch hole through both sides of the grenade body (2-inch pipe) immediately above the shot-shell primer imbedded in the 1/8-inch nipple. Insert a cotter key or an 8-penny nail through the holes. This is the safety device, and it is extremely important and should not be neglected when constructing

and grenades. Do not overlook this procedure. Sharpen the end of the 4-inch long, 1/4-inch bolt. Drill a 1/16-inch hole through the 1/4-inch bolt just above the sharpened point about half an inch. Push the bolt through the cap hole. Slip on a 1/4-inch flat washer and a 1 1/2-inch-long piece of heavy-duty 3/8-inch compression spring. Place a small cotter pin or nail retainer through the 1/16-inch hole. Using the head of the bolt, pull it up through the hole in the pipe cap, compressing the spring between the washer and the cap body. Mark the spot immediately above the body of the cap in the bolt when it is tightly compressed. Drill a second 1/16-inch hole through the 1/4-inch bolt at this point. Pull the spring assembly back and slip a small nail bent in a loop through the hole as a retainer. A piece of wire will also work for this purpose.

There should be about 5/8 of an inch free space between the retracted, restrained bolt and the face of the primer when the cap is screwed to the grenade body. Adjust the pin a bit by screwing the pipe cap in or out. Don't leave the cap in place without securing it with tape if only one or two threads on the pipe nipple are engaged.

It is desirable to test either the scratch or mousetrap-type mechanism before using it with high explosives. Other than the loss of a small amount of fuze and some caps, costs are low. Testing does not hurt the pipe body of the mechanism. My recommendation is to successfully fire five caps in either mechanism before proceeding to loaded hand grenades.

Once you are satisfied that the fuze mechanism is reliable, take the cap with pin assembly from the top of the grenade body. Working from the bottom as before, insert a plastic bag or paint and fill the body with finely powdered ammonium nitrate. The better the job of packing, the better the results. As added insurance, it may be appropriate to glue a small piece of

primer cord to the dynamite cap. Hold back the correct amount of nitromethane in a properly coded bottle. Seal up the plastic bag thoroughly until needed. Do not screw the plunger mechanism on until you are ready to deploy the grenade. Also, do not remove the safety pin until the very last thing before popping the cap.

Nitromethane is added from the top in friction-activated models and from the bottom in cap-detonated (mousetrap) models. These are not complex devices, but they do take more mechanical skill than some people possess. Be very cautious. Extend testing time if it seems appropriate.

I have contemplated packing a dozen 00 buckshot in a 2-inch grenade in place of some of the powder. Theoretically, this extends the lethal range of the device a bit. Yet in its current form, the device detonates resolutely in a positive sort of way. Without having tested these grenades on live targets, I can only assume the extent of their effectiveness. As of this writing, discussions are being held regarding detonating one of the bombs in the midst of some of our chickens. Question is, would this actually be a reasonable test, given the fact that it would probably be very hard on the chickens.

Although completely illegal and quite dangerous, these grenades have the advantages of both a screw-in fuze and a reasonably safe binary explosive. While I have never killed anything with them yet, I know from long experience rolling them down into a draw near our retreat that they are probably extremely effective.

On a still day, the blast from the grenades roils around the hills in a most gratifying manner, tossing grass, leaves, dirt, and sticks into the wind and adding to the overall color of the event. As a hobby, homemade grenades are almost as much fun as mortars—but more about them in another chapter.

CHAPTER 30

MORTAR BACKGROUND

It was an incredible demonstration. Perhaps forty of us sat on a little two-board raised bleacher looking out over an open grass field. It was as if we were sitting on the other guys' 35 yard line peering out over a giant playing field.

Front and right on a little angle, a crusty old master sergeant spread a standard-size olive drab (OD) army blanket. He laid it flat on the ground for use as a target, toward which the old war horse intended to lob his 60mm (2.4 inch) mortar bombs.

Up the playing field far to our left, the fellow started setting up his mortar. I remember as if it were yesterday the coffinlike OD case toted out into the field for him by two hapless GIs. It seemed as though he spent an inordinate amount of time assembling the bipod (legs), tube, and then a little hand-size piece he somehow slipped into the assembly. Then there were the fluted aluminum cans. He stacked these three deep on top of each other, open ends facing the mortar.

"It's the band playing one more round before the dancing girls come out," a friendly young officer opined. "Let him take his time," another man responded, "We don't want him dropping HE on us or even a cast-iron practice round, for that matter."

Some of these gentlemen had already been on the wrong end of mortar fire. Others of us were seeing these things for the first time. Experienced soldiers know that friendly

fire is the most hopelessly impossible military contradiction.

It was about 150 yards from us to the blanket. Distance from blanket to mortar was 600 yards, we were told, and it was at least that far judging by the amount of time it took the sergeant to walk it. We could hardly see what was going on at the launching site. Under the circumstances, I believe, the crafty old sergeant paced the distance so he could be more immediately accurate with his fire.

As it was, his shots with that little 60mm mortar were so accurate he made an impression that I am certain is still with every one of us who saw it and are still alive.

His first round pinged out the tube. After it was out about 100 yards, we could see its black outline high in the sky. It hit with an anemic little black-powder pop, complete with appropriate smoke and a small flash. Incredibly, it landed twenty feet beyond the blanket. By itself it was an impressive display fired at a target measuring no more than five by seven feet. He fired from sufficient distance that he probably could not have seen the blanket had it not been for a slight run in the ground uphill to his location.

His second round, fired no more than 30 seconds later, landed on the blanket. Evidently he was hand-adjusting the tube using little more than Kentucky windage. We could not believe our eyes. He dropped another four or five in a row on the same tiny patch of cloth.

For us his demonstration had the same impact as firing a quarter-sized group on a 200-yard target with a Browning Automatic Rifle (BAR).

"He's sure gonna have trouble fixin' his bunk tonight!" another wide-eyed soldier wisecracked.

Later the same sergeant went out of his way to emphasize how accurate mortars could be if one took the time to learn how to use them and practiced continually. The man claimed that we could do as well if we paid attention to business.

My guess, having spent considerable time reflecting on that incident, is that the old boy probably practiced with tens of thousands of Uncle Gravy's rounds costing hundreds of thousands of dollars. While he was obviously very good, most of us could do as well given enough time and an unlimited supply of practice rounds. He did make the point that small, movable, easily carried mortars were an important tool for the foot soldier.

Mortars were the earliest form of artillery. They were first deployed at the siege of Constantinople by Mohammed II in 1453 A.D. As a result of Mohammed's success, mortars were quickly adopted by European armies along with gunpowder, which was evolving simultaneously.

Early siege warfare as practiced in Europe was ideally suited for mortars. Even using extremely primitive materials and manufacturing techniques, results were reasonably good. They were somewhat accurate in that they could be adjusted to deliver fire on a given city over high, previously insurmountable walls. Because of their stubby little potlike design, they used limited amounts of scarce materials, and they could be fired much more rapidly than any other artillery piece.

Although mortars were reasonably easy to manufacture and deploy, they contained inherent defects, leading some military thinkers of the day to look elsewhere for solutions to their tactical problems. Mortar, for instance, dropped projectiles down on targets from high angles. The generals' problem related to the fact that most of their targets were castle walls, and these barriers could not be neutralized easily by vertically delivered projectiles.

As a rule, they found that castle walls could

only be breached by horizontally fired cannons or howitzers. Catapults and ballistics could be employed to throw rocks and iron at far less cost than gunpowder-intensive mortars. Deployment of mechanical devices constituted far less risk for the operator.

Part of the solution to this dilemma lay in the development of explosive and incendiary rounds for their mortars. These would not breach castle walls, but they had the ability to burn the castle or to otherwise produce casualties and discourage defenders within the walls.

Toward the end of the 1400s, privately owned German contract mortar and cannon companies developed primitive exploding and incendiary rounds for their weapons. These exploding devices were extremely primitive, but they did impress the generals. Users first lit the fuze on the bomb and then the mortar fuze. In the event that the mortar's ignition was delayed, the user could become his own casualty.

Mortars remained as more of a subsidiary device for the world's warmongers than a main battle piece until the start of the 1900s. At that time, lighter, better steel, propellants, and explosives along with the development of cheap reliable point-detonating fuzes brought on a renewed interest in the devices, principally among the Germans and Japanese.

After the U.S. Civil War demonstrated the necessity of fast-moving, mobile units and the futility of massed frontal assaults, light portable mortars finally found their niche. Mortars, the Japanese and Germans found, were not only portable, but in their modern form they could be relied upon to drop huge amounts of explosives on the enemy in a fairly accurate manner on extremely short notice.

Light portable mortars quickly became the modern guerrilla's and skirmisher's friend. They packed well on man or mule, could be installed at the very top of mountains, and the bombs could be broken into loads of two apiece and carried virtually anywhere.

Both conventional and nonconventional forces found mortars cheap and relatively easy to manufacture. Even today, most mortars still are not manufactured with rifled barrels.

Building and Keeping Your Arsenal Secure

Although some of the world's armorers are experimenting with rifle barrels, most still make their mortars of relatively inexpensive, seamless, high-grade, smooth steel pipe.

Training, at least to the point of acceptability, is relatively fast and easy. Fire controls often consist of little more than a spotter with a radio as compared to regular artillery that virtually must operate with a whole bank of computers, plotters, and radiomen as well as a great assortment of ammunition.

Mortars are, in many respects, the ideal weapon for survivors who are serious about defending their retreat. They cheaply and easily concentrate a huge amount of firepower. Their use can be self-taught and, for those who take time to plan their defenses, they are almost impossible to overcome.

However, as a tool of the future, mortars as full-blown defensive weapons may again fall into disuse in the twenty-first century. As a general rule, even in the hand of skilled technicians, mortars require two or three bracketing rounds before they are on target.

Modern development of cheap, light, easily operated radar counterbattery devices that accurately lock onto an enemy mortar crew's position after only a single round mitigate

much of a mortar's advantage. Radar crews may simply wait for a round and instantly report the gun's location, allowing one's own artillery crew to quickly and easily produce three or four casualties among the opposition by returning superaccurate fire.

However, aiming techniques may evolve that allow each side to fire only one round, hitting its target without benefit of or need for bracketing. In this case, mortars would evolve beyond relatively simple devices with primitive sights. Heavy cases of electronics gear both for aiming and counterbattery fire may quickly become the standard. These will require extensive training before they can be used effectively. Manufacturing costs will be high, and large transport capacity will be demanded.

In the meantime, mortars are ideal weapons for reasonably intelligent, hard-working, cautiously brave survivors. If the user is cautious, no one will know he has them, producing an instant advantage in the crucial first engagement.

Because they are relatively cheap and easy to produce and because they give the user an instant advantage, I suggest that everyone seriously consider laying back at least one.

CHAPTER 31

MORTAR DEPLOYMENT

"Destroy the largest, most threatening target at the greatest distance" is good advice not only for conventional military people; it is also excellent advice for the survivor, particularly as it relates to heavy weapons. This advice is enhanced by the fact that most antagonists are unlikely to have any idea that heavy weapons might be encountered.

Mortars are one of the finest, most practical pieces of equipment to whomp an intruder at long range. Homemade models regularly deliver the goods out to 700 yards or more.

Mortars are reasonably cheap and easy to construct, and unlike bazookas, for instance, ammunition is relatively simple to put together in one's home workshop. Practice rounds are cheap and easy. They can be used over and over again, allowing the user to become extremely proficient at little cost. No previous military experience is necessary to use mortars, and, in the process, mortars are great fun to play around with.

In times past, my friends and I have spent countless enjoyable hours throwing bombs downrange. The range was a clear pasture field where we could see the rounds land, not brush-covered, irregular ground over which one is likely to defend his home. Some of the earlier mortars were military surplus models complete with issue sights, bipods, and base plates, but as a general rule we learned to fire our simple homebuilt ones just as well. Most of our devices were similar to the one described

in subsequent chapters. Because our mortars were simple, we relied on eyeball Kentucky windage rather than complex vernier sights for alignment.

Homebuilt mortars can and even should be fired over intimately familiar country to the defender without base plates, leveling devices, or even incrementally adjustable bipods.

Japanese soldiers, for example, effectively operated an extremely simple little device known as a knee mortar throughout World War II. American and Aussie GIs who tried firing it from the knee found out the name was misapplied, but it was an incredibly portable little machine. There were several evolutionary models of the knee mortar, all in 50mm (2.1 inches) and all weighing less than eleven pounds.

They used a special propellant cartridge to throw a standard Japanese hand grenade out a maximum of 710 yards. Firing was accomplished using a trigger mounted on the tube support rod. Japanese infantrymen considered these clever little mortars as a bridge between hand-delivered hand grenades and true mortars. In that regard, their use was similar to that which one should plan for survivors. In many respects our own military validated the concept of small mortars when they brought out 40mm M-79 and M-203 grenade launchers.

Model 10 grenade dischargers, as they were then called, had no sights or bipod. A single

arm with a cupped base made to slip over a rock or log was all that positioned them. Although most users probably never heard of Kentucky, it was the only way they could be aimed. Users simply angled the device in the direction of the target as they thought appropriate and fired away, based entirely on present conditions and past experience.

More conventional mortars fired in battery using forward fire control require solid base plates for support as well as rigid, easily incremented bipods. Even simple homebuilt models require something substantial on which to place the tube if the ground is soft or moist. After firing only a few rounds, mortars will drive even large solid base plates down into the ground. Smooth tubes may bury themselves so deeply that aim adjustment is no longer possible. It is not uncommon for GIs using conventional munitions and base plates to have to dig their mortars' base plate out of the earth when they move to a new location.

If fire is to be concentrated accurately from many mortars, these amenities are a requirement. Survivors who will probably deploy only one barrel at any given position can easily make do with base plates made from a pre-notched piece of log or a rock previously stashed at their firing points. They will not find it necessary or desirable to haul around a heavy base plate nor go to the trouble and expense of constructing them.

Survivors are usually terminal tinkerers. Some may wish to spend additional hours of work constructing a mortar that is true in every detail to standard military-issue models, or they may purchase a bipod base plate and sight from parts suppliers who advertise in *Shotgun News*. While doing so may be recreational, it certainly is not necessary. Spartan models, as subsequently described, will do just fine.

As mentioned, mortars by design can deliver a fairly high rate of fire by a user operating completely in the blind. By employing a forward observer, users can sit safely over a hill or in a hollow pouring fire down on an enemy who can neither see nor be seen by the users.

Home builders can accomplish this sort of delivery if they practice with their mortars and learn to use forward observers.

Effective forward observers must also learn to remain out of sight, know the country as well as the mortar's operation, and be equipped with a good, hand-held two-way radio. Firing at a spot where one's opponents have been pinned down or have fled for refuge from small-arms fire is an appropriate target for one's mortar. Fortunately, in this day and age, easy acquisition of good FM or CB radios makes this mission possible.

After spending enough time firing practice rounds at fixed targets to feel comfortable with their mortars, survivors may want to make the next quantum leap and begin to engage targets from defilade positions. This is much more entertaining if users have a large amount of inert practice rounds at their disposal. They can adjust till they finally start dropping rounds right on the target.

This sort of practice requires large amounts of wide-open spaces on fields that have either short crops or crops that have recently been harvested. A freshly combined bean or pea field or newly mown and baled hayfield is a good example. Practice of this sort can be done in relatively populated areas because the rounds do not detonate or otherwise disturb the natives—unless, of course, one inadvertently drops an errant round through a neighbor's barn roof.

Users who practice on rough, irregular country of the type usually found around retreats will find that they lose a lot of their practice rounds. They just go out of sight, fall into heavy brush, and can't be found, or they break up on impact. Painting the rounds bright silver or shiny red helps a bit, but it is no guarantee that they will not be lost, and, of course, breakage is still a problem.

Plan to practice occasionally with fully loaded rounds even if this means driving to some other area where the people are not as nosy. It is wise to undertake these tests only after one is proficient with practice rounds (i.e., one can regularly get them reasonably near the target) and there are no longer prob-

tems with improperly loaded booster cartridges, equipment breakage, or simple miscalculations.

As a rule, it is not practical to plan to engage vehicles with one's mortar. They are too fast and can get out of range of a mortar quickly. Wheeled and most track vehicles generally run on fixed paths, and pre-planned set charges are much more efficient and effective for these. Plan, instead, to protect the retreat with numerous preselected, preset charges strung out along the approaches. Handle intrusions of large bodies of people with the mortar, hand grenades, and claymores. Practicing with that plan in mind is much more productive than leaving the organization of one's retreat defense to chance.

Mortar barrels and fittings are quite cheap and easy to put together. Wrapped in oily cloth, a large number of tubes can be hidden in convenient firing points around one's property, or survivors can carry a single tube from place to place around the property. A sling can be fitted onto the tube, making it easier to carry.

Carrying around a 20-pound tube is accept-

able if a second and even third ammo bearer is available. Mortars work best against personnel when ammunition is expended lavishly. The minimum is probably four to eight rounds per barrage. It would take a very determined man to carry a tube plus eight rounds of loaded homemade mortar ammo over rough country.

Probably the most ideal position in which to set up a mortar for a survivor is on a prominence from which he can drop rounds long distances (up to 800 yards) while observing their impact. Obviously, tremendous amounts of beneficial fire can be delivered when the user can see the target as well as the rounds detonating. If this position also protects approaches to the retreat, it is that much more desirable.

Under these circumstances, however, the survivor stands a strong chance of being surrounded and cut off. It is better, I believe, to slip through the hills, valleys, and brush unseen and to then drop relatively powerful bombs in the near proximity of an enemy from unknown locations. Then the group can reassemble in heavy cover and organize yet another attack on a still groping enemy.

CHAPTER 32

HOME CONSTRUCTION OF A WORKING MORTAR

Building a workable mortar in one's home workshop is so simple you'll wonder why you waited so long to do it. Most of the parts can be purchased off-the-shelf from your friendly plumber's supply house. The challenge, if there is one, relates to acquisition rather than to any complex building, welding, or tooling.

Mortar tubes can be constructed from 3-inch pipe in any length from 18 inches up to about 6 feet. Obviously, shorter lengths would be easier to hide and to pack around, and they are also far less costly. Yet they sacrifice quite a bit in terms of accuracy, reliability, and range. Most builders favor tubes in the range of 36 to 44 inches.

Having decided on the length, go to your most user-friendly, convenient machine shop or steel supply house. Purchase whatever length you want in 3-inch inside diameter tube. With any luck, the machine shop you choose will have some good used drawn-over mandrel (DOM) seamless pipe at reduced rates.

Regular 3-inch plumber's pipe will work if seamless is not available, but it is not as strong nor, in many ways, as easy to work with. Common 3-inch pipe sells for about \$3.50 per foot. DOM seamless runs about \$2.50 to \$3.00 per inch new. Unless one scrounges and searches, a new 40-inch-long tube could cost up to \$120. Under many circumstances, good mortar tubes are worth far more than \$120, but usually it's much more money than you have to pay.

If high-quality DOM is available in good, unpitted, basically rust-free used condition, buy the correct length and have the machine shop put a thread on one end of the pipe. You may also ask them about constructing a solid steel end cap for the tube. Tell them the outfit is to be used as a steel fence post-pounder. Custom constructing a steel end cap will cost some bucks, but it is far better than simply threading an issue cast-iron pipe cap onto a good, solid-steel tube.

If the device fails, it is almost certainly the result of cracking of the cast-iron end cap. Although quite a lot can be done to reduce the cracking of regular stock 3-inch cast-iron caps, expect them to fail with regularity. Pressures within the tube are relatively low, despite the heavy load being tossed out. Certainly it can happen, but I have not seen even a pipe-type tube crack in a number of years.

At this point, I will assume home builders have a 40-inch tube with one threaded end and either a custom-built end cap or an off-the-shelf plumber's variety. Find the exact center of the pipe cap. Carefully drill a vertical 5/32-inch pilot hole through the center of the cap. Purchase a hardened 3/8-inch machine bolt 4 inches long plus two correct machine thread nuts for the bolt.

Using a regular 3/8- by 24-inch NF die, cut threads from top to bottom on the bolt. Carefully sharpen the end of the bolt to a fast,

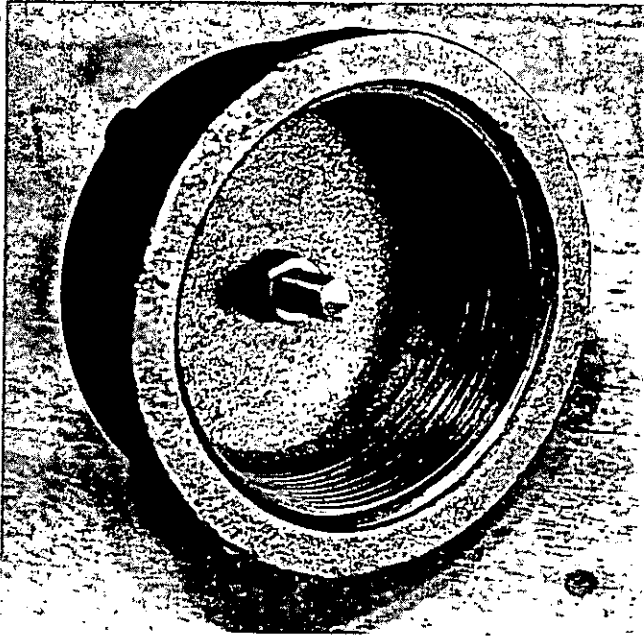

Standard 3-inch pipe cap is drilled in the exact center with a 21/64-inch drill and tapped with a 3/8- x 24-inch NF tap. A fully threaded 3/8- x 24-inch machine bolt is threaded through the cap and locked on the cap with a nut. Note pointed end of bolt.

quickly beveled point. Do not make a long, thin point because it will break too easily. Drill out the pilot hole in the tube cap to 21/64 inch. Thread with a 3/8 inch by 24 NF tap. Be very careful to thread the cap in a perfectly vertical manner. This is the most complex part of home manufacture of a mortar tube. An adjustable firing pin is necessary if one is to produce a working mortar. Eventually this pin must be set so that it just barely detonates a cap on the projectile when it is dropped down the barrel.

Place a locking nut on the back of the bolt. Thread the bolt through the cap with the pin extending through the concave portion of the cap. Extend the point up past the surface of the cap about 1/2 inch. This is a trial-and-error procedure that is best done with inert rounds containing a primer but no propelling charge. Drop sufficient inert rounds till you are certain that the firing pin protrudes up through the cap just enough to detonate the primer and that it is centered properly.

Unscrew the cap off the tube. Using a camp stove, propane torch, or other heat

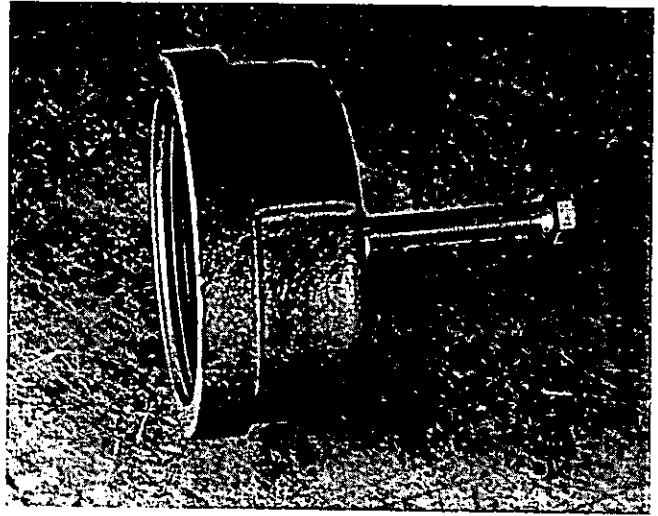

Side view of firing device for a 3-inch mortar. Later the cap is partially filled with molten lead to keep it from cracking under pressure of repeated firing. Firing pin must remain adjustable so that it can be set in a precise manner.

source, melt about two pounds of plumber's lead containing at least 5-percent tin. After the lead is liquefied, pour it into the concave portion of the mortar tube end cap. Pour it only into the bottom edge of the threaded portion of the cap, not up in the area where it will prevent the cap from being securely screwed to the mortar tube. This quantity of lead will warp when cooling but, in spite of this, will cushion the cap, extending its life at least fivefold.

Give the bolt firing pin a quick turn or two, loosening it as the lead hardens. After the assembly cools, tighten the buck nut down onto the back of the cap, securing it to the cap and lead buffer. It is imperative that the firing pin be adjustable in and out after the lead cools and that it be adjusted down so that the firing assembly reefs against the lead block.

Leading the cap will strengthen it, but after prolonged firing with heavier charges, the cap will still crack. It is best to make two or three extra caps now before the time of critical need. It is sometimes difficult to get the firing pin absolutely centered in a home workshop, so builders may wish to have this cap work done in a machine shop.

Solid-steel caps are less apt to crack but are much more expensive and difficult to pur-



Strap assembly around the mortar tube holding support legs.

chase. Screw the cap securely back onto the end of the mortar tube.

From either a scrap pile or a cooperative steel supplier, get one piece of 1-inch mild steel, 1/4-inch strap, 15 inches long. Using a heavy hammer with the tube as a template, place the strapping on a heavy long anvil or scrap of tube-size pipe and beat it into rounds that clasp nicely around and onto the tubes.

Drill holes through the ends of the steel straps and, using 1/2-inch bolts, securely fasten the strap about 12 inches down from the top of the upright tube.

Purchase two pieces of 3/4- to 1-inch diameter steel rod 30 inches long. Weld or braze two 1/2-inch washers to the top of each steel leg. Run the 1/2-inch bolt used to secure the tube clamp through the washers on the two legs. Since the legs have to move in and out a bit, it helps to place a couple of flat washers next to the welded washers. Ideally, the legs should flex in and out so that the tube can be angled up or down a bit.

These legs become the upright support for the tube. Shooters can move them to provide more horizontal distance as opposed to additional vertical distance when launching the

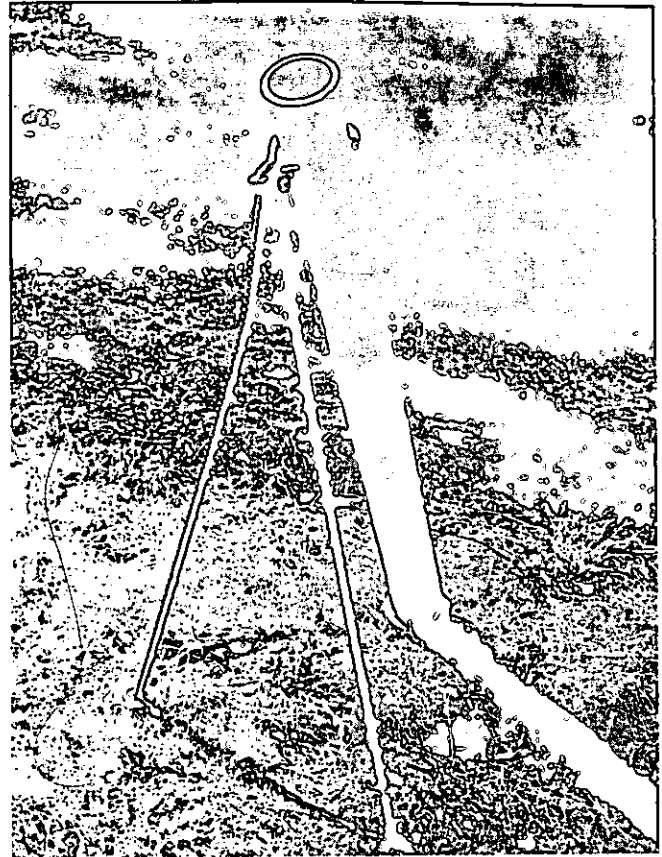

Three-inch mortar with base firing mechanism and legs installed, ready for use.

projectile. This arrangement is not superaccurate, but it works nicely over a distance of 400 to 700 yards. Since the blast radius of these rounds is about 30 feet, users don't have to get the bomb right on the blanket for it to be effective. As mentioned, I have traditionally not used a base plate, relying instead on coarse gravelly ground rocks, logs, or wooden planks on which to place my mortar tube. I leave all of these at places where I believe I may deploy my mortar.

Constructing mortar bombs is a bit more difficult, but it is still far from exacting work. Again, patronizing one's favorite plumbing supply house, secure a 2-inch black pipe nipple 6-inches long, two 2-inch pipe caps, and a 4-inch-long 3/4-inch nipple. At a hardware store, purchase a 1/2-inch fender washer, which conveniently is just shy of 2 inches in diameter. Also purchase a little 1/4-inch washer at this time.

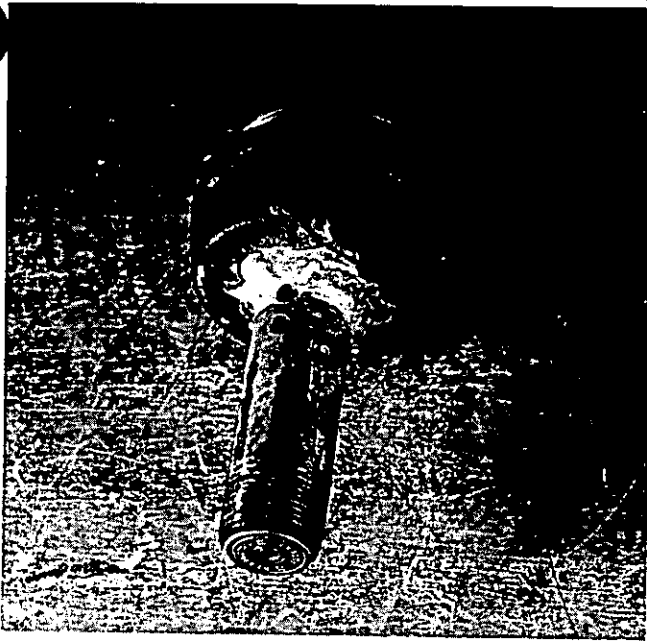

Mortar projectiles are made by brazing a standard 3/4-inch pipe nipple 4 inches long to the exact center of a 2-inch pipe cap. Drill a number of 5/16-inch holes through the nipple to act as gas vents for the blank shot shell shown inserted in the bottom end of the nipple.

Find the precise center of the 2-inch pipe cap and drill a 5/32-inch pilot hole through one cap. If a 3/4- by 14-inch pipe tap is available, drill the center pilot hole in the cap out to 15/16 inch. Thread the hole through the tap so that the 4-inch long 3/4-inch diameter nipple can be threaded securely into the cap. As an added measure, I braze the nipple top and bottom to the cap. This assembly must be on absolute center, or numerous misfires will result.

Measure down from the pipe cap 1 1/2 inches on the threaded 3/4-inch nipple. Working only above this line, drill at least ten 5/16-inch holes through the pipe, perforating it thoroughly. These holes bleed off the propellant charge from the 12-gauge shell when it fires.

A 12-gauge shot shell will fit easily into the end of the 3/4-inch nipple. A small piece of electrician's tape may be needed to bush the shell so that it does not fall out of the pipe when it is carried around roughly. Use only shot-shell primers to test the mechanism. When certain that the mechanism is working, graduate to propellant and inert practice rounds.

Propellant should be 30 to 60 grains or

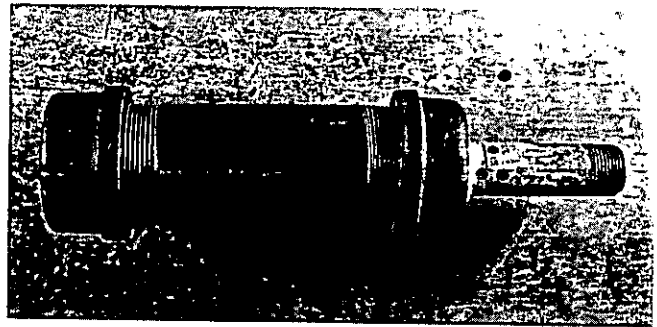

Side view of a mortar projectile made of two 2-inch pipe caps and a 6-inch pipe nipple. A hole is drilled through the lower (left) pipe cap and a 3/4-inch nipple brazed solidly in the exact center.

more of Bullseye or Herco shotgun powder or a 12-gauge case full of Hodgins' Pyrodex CTG. Exact loading will depend on the weight of the projectile, the distance over which one wishes to fire, and the quality of the steel in the tube.

As an initial experiment, load the projectile body with 1 1/2 pounds of sand gravel or other convenient filler. Some users construct plastic break-apart tubes filled with powdered lime that make a nice white cloud when they hit. Screw the top cap on securely and bush both caps with electrical tape so that the round will fall straight down the barrel. I find it necessary to use a full 6-inch-long piece of 2-inch pipe so that sufficient distance between contact surfaces holds the 3/4 nipple rigidly in the center of the tube. Off-center propellant tubes are prone to misfires. At first, misfires will be a constant problem. Simply dump the round out of the tube, adjust the firing pin, change end caps or straighten the 3/4-inch nipple on the round. In the field, doing all this can be exasperating.

Practice shooting inert projectiles over the country in which you plan to operate. It is helpful to paint the rounds red or silver so that they can be retrieved and fired again. I recommend not loading the rounds with explosives until one has successfully fired at least 100 inert rounds.

Fuzing and charging these rounds when the time comes is relatively straightforward. In my book on homebuilt M-79s and M-203s (Part 6), I described a point-detonating device, but these are probably much too dangerous for

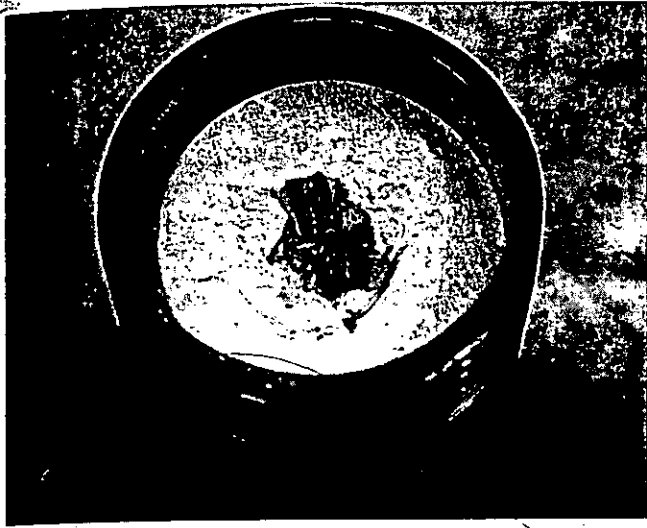

A standard 12-second piece of dynamite fuze glued to a 1/2-inch fender washer. A match head is placed in the center of the split fuze and the entire assembly anchored solidly 1 inch into the base of the projectile body. Explosives are packed in behind the washer as an added deterrent to the assembly's moving when the round is fired. Heat from the blank shell lights the match head and fuze.

home manufacturers to fool with, especially when only modestly dangerous fuzed rounds are available as an alternative.

As with all homebuilt destructive devices, the ultimate secret that makes this work is knowing how to home manufacture C-4. With this material, a great number of things are possible.

Start by testing your dynamite fuze to determine burn rate. Cut off a section of fuze that is certain to provide 12 seconds' burn time before detonation.

Using heavy glue, secure a small 1/4-inch washer inside a 1/2-inch fender washer. Fortunately, the outside diameter of the 1/4-inch washer just about matches the inside diameter of the 2-inch fender washer. Allow the two to dry thoroughly.

Push the segment of dynamite fuze through the 1/4-inch hole and split it back about half an inch. Securely glue these split halves onto the washer face. Be careful that no glue gets onto the internal powder train of the fuze. Cut a match head from a strike-anywhere match and, using a little dab of contact cement or Duco glue, fasten the match head into the cen-

ter of the powder train. Crimp a number 6 dynamite cap onto the fuze. As an added precaution, glue an inch of 50-grain primer cord to the cap as a booster for the explosive.

After securely fastening the bottom cap with the 3/4-inch pipe nipple attached to the projectile body, drop the fender washer and fuze in from the top of the projectile. The spread fuze and match head should "look" straight down the center of the 3/4-inch propellant pipe nipple.

Using large amounts of heavy glue (such as Goop), secure the fender washer in place over the 3/4-inch nipple in the projectile body. Allow at least two days for the glue to harden. It would be better to weld this rifle in place, but because of the proximity of the dynamite cap, this is not possible.

Using a wooden tongue depressor or other blunt wooden probe, tamp a lightweight plastic bag into the pipe body. This is a difficult task—given the fuze and cap sticking back into the pipe center—but make sure every corner is filled by plastic bag. This plastic liner seals the chamber and keeps air and moisture out of the powdered ammonium nitrate, which is easily ruined by air or moisture.

Carefully tamp in layer after layer of tightly packed, powdered, washed ammonium nitrate into the tube. Keep track of the amount used so that a correct amount of nitromethane can be set aside for later use. After filling with ammonium nitrate, seal the plastic bag and set the top end cap securely in place. Make sure that enough pressure is exerted on the washer's fuze assembly, packing the powder into place. The force of the firing blank tends to dislocate the washer and fuze. Code the small plastic bottle of nitromethane and keep it with the round. Shortly before use remove the top cap, open the bag, and pour in the nitromethane. Charged rounds can be held several weeks in this ready state, but I see no reason to do so because of the added risk.

A dozen 12-gauge propellant cartridges can be made ahead of time. Use a thumb-tip-size piece of cotton as wadding over the powder.

Seal that with six or eight drops of Elmer's glue. Allow the glue to thoroughly dry.

A mortar complete with HE round is not quite as easy to assemble as this brief description might indicate. At first, misfires are common. Even very small adjustments on the firing pin make a considerable difference. Mortars are dangerous, and they can be erratic. Exercise extreme caution if you decide to build a mortar for use with anything other than inert practice or smoke rounds.

Paramilitary survivors often find smoke rounds useful. They can be used to confuse the enemy and to obscure one's movements from firing position to firing position. Construct a smoke-generating round for your mortar by drilling twenty or thirty 3/8-inch holes in the 2-inch diameter nipple at random along its 6-inch length. Line the inside of the projectile body with a plastic bag as with the HE rounds. Instead of a dynamite cap, split the end of the 12-second fuze segment and glue four strike-anywhere match heads to the fuze in such a way that they light when the fuze burns down.

Fill the body of the projectile with sugar chlorate powder thoroughly mixed with 8-percent (by volume) powdered charcoal. Common, finely ground barbecue brickettes are fine for this purpose. The rounds are propelled and detonated with a 12-gauge blank round exactly like the HE rounds.

The last time we fired mortars, conditions were ideal. We selected a neatly cut and baled alfalfa field that was bare as a billiard ball. It was relatively easy to spot our practice rounds after they landed in the dust. Pleasant little breezes did little to spoil our aim.

My accomplice, who seldom had an opportunity to fire a mortar, set up the tube on a piece of thick canvas tarp in an attempt to minimize involvement from the thick, micaeous dust that lay over the field like a mantle. We had twelve projectile bodies with which to practice along with about four boxes of 12-gauge propellant cartridges loaded up the previous week. All contained 40 grains of Bullseye powder, which was not a maximum load as

we soon discovered, but one that was fun to play with.

I measured off 400 paces up the gentle rise from the point at which shooting would be done. My friend, while not terribly experienced with mortars, was a seasoned pro with numerous other weapons. He understood trajectories and throw distances much better than I would have supposed.

With intense concentration, he fired the first round downrange, being cautious that it traveled at least 50 yards in front of me. Theoretically, we should have been able to see the giant pipe projectiles arcing through the blue, thus avoiding being hit on the head. But as with all things human, the leap from theory to practice is often corroded with errors.

I saw the smoke from the discharge a second or so before hearing it. Sounds from mortars are very subdued. It was only possible to see the round arcing through the sky after it was out about 60 or 80 yards. Then at the top of its arc, I lost contact. It looked as though the round was far enough to my front, but instinctively I put my hands over my head and started walking backward. An incredible combination of poor luck and circumstances would have to align themselves for me to be hit with a projectile, but at the moment I wished to take no chances.

Finally after what seemed like—and probably was—5 seconds, the round hit well ahead of me in the dust. The shooter had tried to get it even with my position, succeeding very nicely.

Satisfied with the test, the shooter picked out a patch of low-growing morning glories that provided an unusually green splotch on the ground. The target was about another one hundred yards past my position.

His second shot landed beyond the patch, a fact that I quickly relayed back. His next ten shots all landed within 20 feet of the patch. He used a little piece of split pine log about 20 inches long as a base plate. After a shot or two, recoil from the tube drove it down into the soft wood, indenting it in the shape of the end cap and firing pin.

Hauling twelve heavy empties back to him

was more of a chore than one would first imagine. Even after only one shot, one of the nipples was bent sufficiently to preclude use. We were down to eleven practice rounds.

Next he turned his attention to shelling a high weed patch out about 600 yards to the side. His first round went way wide. Eight of the others were reasonably close, while two were completely erratic.

This time we lost one round, and one was damaged. We spent the remainder of the morning plopping those inert rounds down-range, retrieving, sorting for damage, and firing again. It really was great fun, as well as a challenge to do well. Eventually, we lost or damaged all twelve of the bodies. Some were fired eight or ten times.

Finally it was time for the big one we saved for the last. I picked the loaded HE round out

of the box in which it traveled. My friend slipped a 12-gauge propellant charge into the 3/4-inch tube.

Gingerly, we let it slide down the tube till it hit bottom with the customary soft metallic ping. We wondered if this would be another erratic round. As before, we saw the round going up to the top of its arc, but perhaps helped by either practice watching or the smoking fuze, it fell down toward the target. At the target it bounced twice, and then, as if held magically in midair, it detonated with an incredible roar.

We vividly recall pieces of the projectile kicking up little dust trails around the impact zone for perhaps 50 feet or more. Then the cloud of dust stirred up by the detonation obscured the field.

It was an extremely gratifying experience.

CHAPTER 33

CLAYMORE BACKGROUND

"Why is it," I thought, "that both mosquitoes and people get smaller as one nears the equator?" Exercising all of the determination and self-control I could muster, I tried to ignore the tiny little devils (mosquitoes) by considering philosophical matters as they busied themselves trying to suck all of the remaining blood from my exposed face and hands.

In the situation in which I found myself, I could not think of using smelly mosquito repellent. To do so among these alert bush people was to raise an instant alarm. Downwind these guys can smell you sweat fifty yards away, I was often reminded. Desperately, I risked running my hand over my bare forearm. It felt sticky but not very noisy.

Waves of stinking heat containing clouds of bugs of all types blew up from the water's edge below. It was some of the most miserable duty one could ever imagine. It was beginning to look like far more than either my companion or I had bargained for.

Two of us picked up a Mitsubishi four-wheel-drive at a car pool in Quito, Ecuador, two days prior. Taking turns driving, we finally ground our way through hundreds of miles of slick, soft, miry road to a desperate little place appropriately called Coca, Ecuador. It was definitely the End of the Road. Ahead, running wide and deep, lay the fork of the Napo River, the main tributary of the mighty Amazon.

In Coca an Ecuadorian army officer met us. He was officially designated to document

unofficial cross-border traffic down out of Columbia into Ecuador via the Napo River and some of its tributaries.

About 2:30 P.M. we arranged for transport down the river about thirty-five miles, where a tributary ran out of Colombia, reportedly used by numerous nefarious persons. It took us less than two hours to make the run in the much-used, noisy open boat.

At our camp spot, the guide pulled a number of rubberized duffle bags in reasonably good condition out of the vessel, ordering the operator across the wide river about a mile to a little bayou where he was to spend the night sleeping in the boat.

We unpacked the gear, finding among other things several canvas ground cloths, two Heckler & Koch MP-5s, a couple of flare pistols, about two hundred feet of 22-gauge electrical wire, two jungle hammocks, and yards and yards of mosquito netting. We also had several U.S. MREs (meals ready to eat). I wondered how the Ecuadorians got them so quickly.

"Before we do anything, we must set these up," he said as he unceremoniously dumped three ugly green plastic claymore mines out on the sand. It was my first introduction to these devices. Since I was more than a little interested in explosives, I took my time examining them.

It was curious how easily the fiberglass back panel came off, exposing a puttylike, cream-colored material. Rows of steel, not

lead, balls were set in the front covered by a very flimsy fiberglass screen. Two steel legs folded down out of the little device.

At the colonel's instruction, we set the claymores up on the opposite bank facing a sandy little alcove where he thought boats landed. "We will shoot a boat for you," he said with a big-tooth smile. It was about two hundred feet back to our position on the main river on the other side.

Because of fooling around with the claymores, we were unable to string mosquito netting in any effective manner before darkness descended. We simply spread out on the ground cloths huddled under netting strung haphazardly from rope and limbs.

As we quieted down, the brush around us came alive. There were the croaking of frogs, rustling and flapping in the treetops, and, of course, the incessant humming of insects.

It was impossible to sleep. We alternated between being slightly chilled and then breaking out in a sweat. We listened very intently for noise on the opposite bank. After a long time, we could barely hear the sound of something mucking around in the water. It was a subdued splashing, and then we thought we could hear the soft padding of feet.

Suddenly there was something up in the grass above the bank. I froze tight with anticipation and fear. It was just possible to see the whites of the colonel's eyes and his hands. With them, he cupped a small squeeze-type generator, similar to devices used on generator-type flashlights.

When the noise came again, I could barely look over at my friend, the situation was so tense. Had it been mine to do, I probably could not have fired the claymores. It was as much reluctance to break the strange silence and give away my position as basic fear that immobilized me.

When the claymores detonated, it was as if a white light shown instantaneously on the other shore. The noise was high-pitched and piercing, but not nearly as loud as I originally supposed it might be. Then silence again. After a bit, crickets and frogs started their

chirping again. Mosquitoes continued to hum. I expected some small-arms fire, but there was nothing.

We simply sat till first light, not knowing what to do. At full light, neither of us really wanted to stick our noses over the sandbank. It appeared that the colonel was as fearful as we were under the circumstances.

Ever so cautiously, we peeked down over the other side. It was difficult because there was nothing to see. Finally we crawled over the divide, verifying that there really was nothing to see.

Some of the brush behind the claymore site was shredded and hacked down, but in general there was nothing to observe. I looked for tracks in the sand or marks from a boat keel, blood, paper, dropped equipment—anything. But there was nothing to see, except some small groups of feathers floating in the back-water and strung out up on the shore.

The colonel wouldn't admit it, but I believe to this day that we claymored some small ducks or shore birds that were paddling around in the still water, and that some animal—such as a civet cat, snake, or even a crocodile—came in and carried off the carcasses. Or perhaps we didn't get anything at all.

No human set foot in the area that night, and we didn't wait around for the next night. "Claymores all gone," the colonel reminded me.

Claymore mines were one of the better instruments of death and destruction to come out of the Korean War. U.S. contractors working in think-tank-like environments successfully developed a method and weapon for dealing with Chinese human-wave tactics. They determined that U.S. GIs needed something to set out far in front of their foxholes for use as a trip-wire deterrence and then as a last-ditch measure for people who did not seem to care what level of casualties they took.

At first U.S. soldiers tried a number of anti-personnel devices, many of which were simple variations of semipermanent installations

Using regular hand grenades or field-expedient deployments of C-4 and metallic scrap.

All were somewhat effective because of the cleverness and determination of the makers and to the amount of time they had to place these devices. Often, U.N. forces in Korea were put on-line at 9:00 P.M. only to have to endure human-wave attacks at 3:00 A.M. Under these circumstances, GIs had little time to do anything except bring up large numbers of conventional hand grenades.

Hand grenades were efficient out to about 40 meters, but they required the user to expose himself somewhat and were limited in the area they could cover effectively.

What was needed, our military thinkers reckoned, was something quick, easy, and cheap—ready to go at very little notice. They wanted a device much like a Scottish two-handed claymore sword that could deal effectively with large numbers of people at one stroke.

In a modern context, they also wanted a weapon that would deal with large numbers of enemy coming along a predetermined avenue of approach, much like a small cannon or large shotgun. Such a device should be capable of remote-controlled detonation, they reasoned. The device should be able to be installed quickly and unobtrusively in rows, firing in volleys till the enemy became discouraged or were all casualties.

As a last resort, grenades could be deployed by hand at any enemy still standing. There was even talk of deploying an electrically fired, single-blast device from a truck or track, providing a tremendous response capacity for use when GIs ran into a road ambush.

It is interesting to note that by the time Vietnam rolled around, U.S. GIs had a device named after the legendary Scottish two-handed swords. Claymore antipersonnel mines met all of the original criteria in a most admirable fashion. The mines were cheap, effective, easily deployed, and ideally suited for remote-control detonation. They guarded paths, became the core of ambushes, and were used to protect bridges, gates, and outer-perimeter wire with little risk to the soldier.

Ironically, Russian and, in their turn, Chinese armorers came to the same conclusion regarding the utility of remotely detonated antipersonnel devices. There is some indication that the Russians had claymore-type mines before the United States.

However, the Russians and Chinese intended to use the weapons offensively as booby traps rather than defensively as a tool to repel hordes of suicidal Americans attempting to overrun their positions. Perhaps Communist strategists knew that it had become politically unacceptable for Americans to take all but the most minimal level of casualties. In any combat in which they engaged, these strategists might have reasoned, cleverly placed antipersonnel mines could produce far greater political results than one would first suppose.

Chinese claymores were thick round plates about the same diameter and shape as three conventional dinner plates stacked together. Deployment often involved hanging these plates in treetops in areas of U.S. troop movement. At times the enemy simulated troop activity on the ground in an attempt to lure helicopters into range. They were also used much as American claymores were on trails, in front of bunkers, and on bridges and dikes where casualties were sometimes rather indiscriminate.

Using the extreme patience and stealth for which they were known, Vietnamese sappers were able to achieve some truly remarkable booby-trap installations. These included detonating up through tunnel entrances when the covering plates were slid aside. Traps were hidden in rice shocks and fired into paddy dikes from spider holes at places where GIs were likely to take refuge. They were also set to rake paths along which American soldiers were likely to patrol.

U.S. soldiers used tens of thousands and perhaps millions of claymores in Vietnam in what amounted to their first battle use. They went over in a very big way. Deployed in conjunction with infrared and night-vision devices, they virtually stopped Vietcong (VC) night attacks. Claymores were often fired on

the river when the user heard movement in the darkness—similar to the ones we fired in Ecuador, but reportedly they usually got more than ducks.

As a result, old Victor Charlie had to develop other nonguerrilla tactics with which to keep pressure on Americans. One of these tactics was to make additional use of artillery, especially mortars. Human-wave attacks, they found, were no longer effective offensively.

Not only did mortar rounds produce casualties, but near misses also disrupted carefully placed arrays of claymores, cut their wires, and generally made them less reliable.

Yet as the war ground on, more and more

GIs relied heavily on claymores for perimeter defense, remote ambushes, and early warning when the enemy stumbled into them outside the wire.

Since the Vietnam War, nothing that has occurred—including in the most recent warfare in Iraq—has change anyone's mind regarding claymores.

Principally because of their simple, effective operation, claymores are now standard-issue weapons for American fighting men. During desperate times they can provide a significant margin for survivors. Although simple to make and relatively easy to deploy, homemade claymores have not been previously recognized for personal use by survivors.

CHAPTER 34

CLAYMORE MINE DEPLOYMENT

It appears to me that claymore antipersonnel mines are one of the most uniquely effective defensive weapons a survivor can own. However, as of this writing, I have not been forced to defend my retreat using them.

James Dunnigan, in his excellent and exhaustive book *How to Make War*, records historic casualty rates among soldiers for vehicle accidents, small arms fire, artillery, venereal diseases, and other similar maladies troopers are likely to encounter. Yet he makes no separate mention of antipersonnel mines other than remarking briefly that "they are a problem for the unfortunate foot soldier." Perhaps extensive American use of claymores led to the other guys suffering all the casualties. One would think, however, that if claymores are as effective as they seem in theory that they would rate a mention in *How to Make War*.

Despite the currently available statistics, I remain convinced that cheap, easily built claymores would be absolutely devastating in the hands of survival paramilitarists.

Claymores can be useful wherever intruders are likely to move, park their vehicles, store goods, or pass through choke points. Claymores are ideal for protecting access to one's retreat, preventing gates from being forced open, funneling people in kill zones in open fields, and closing roads through hilly or wooded places. There are thousands of places where one could hide a device with a 40-foot frontal kill radius if he simply gave the prob-

lem some thought. A claymore can double for a rifleman in a foxhole on an overlook when personnel around the retreat are spread thin.

Electrical wire used to trigger claymores can be run in booby-trap fashion or run hundreds of feet to a central command post if that's what the situation demands. In some cases one can do both, assuming one has sufficient time and energy to make adequate preparation.

Two cautions apply to claymores, which amateurs may neglect or feel inclined to ignore:

1. Do not plan to use claymores to defeat vehicles. They are not suited to that purpose. Chances are that you could not immediately knock out even a farm truck with it, causing the intruding operators to be extra cautious for the device you will have planted on down the road that could actually knock out the vehicle.

Since claymores are cheap, easy, and durable (remaining on duty for weeks at a time with little maintenance), they are far more effective for the passengers inside a vehicle than the vehicle itself. Place claymores high in trees, aimed at spots where vehicles are likely to park and discharge their crews. Mines emplaced in the road to blow a tire or track off a vehicle are more effective against vehicles. You may wish to supplement the mine with a claymore set to take out the vehicle's personnel, but do the main job on the vehicle with a mine.

If it is totally impractical to mine one's

road, instead, clear out an inviting parking area away from the retreat that unfamiliar intruders are likely to use. Protect the area with claymores set to wipe out a crew from virtually any direction.

2. Make certain that the first bank of claymores does not destroy the wiring or triggers on the second set of devices. In other words, plan not to shoot down the second line of claymores with the first, assuming one sets up a primary and secondary defense system.

As an added note to this caution, be aware of the back blast from these animals. These are not military-grade devices having a rear kill range of only 15 meters. Back blasts on homemade claymores easily strip the leaves from bushes and low lying trees up to 20-meters to the rear. Apparently our plastic back-blast shields are not as tough as commercial models. They vaporize into sharp pieces, propelled backwards at very high velocity. However, the plastic pieces are extremely light, carrying little residual energy for any distance.

Use caution that different levels of these devices set on posts, trees, and the ground are placed so they do not knock each other out either by front blast or back blast. This may involve burying one's lines a few inches under ground, placing the front device high in a tree, or simply aiming them in such a way that they do not impinge upon each other.

Vietnam-era GIs who deployed claymores reported that they encountered several extensive problems. Nevertheless, most who actually relied on them in ambushes or to protect their fronts spoke highly of the damage inflicted by claymores.

The veterans did mention some disadvantages. Weather was often a real headache for users. In some extreme cases, lightning storms prematurely discharged the carefully placed charges. This needlessly exposed the men's presence and left approaches to their bunkers undefended at a time when it was impossible to install fresh units.

In other instances, heavy rains created seas of mud too unstable to support the devices. The claymores were either engulfed by moving mud

or fell uselessly on their faces. At other times, mud and rain so dampened the devices that they were ineffective when they did discharge.

Another pervasive problem often encountered involved the bad guys creeping in and turning the devices around so that the business end faced the original owners. At times this was done in the dark of night or even by surreptitious members of the indigenous population working on the installation. GIs countered this threat by placing white strips of tape on the back of the claymores. By so doing, they could tell at a glance if any tampering had occurred. They also found they had to keep weeds and grass trimmed down behind claymore installations so that they could observe the emplacements at all times.

It was common for GIs to place lone claymores 200 or 300 hundred meters out in the country at a trail intersection or at places when a path packed down over a rice paddy dike. During the night they monitored with seismic and infrared devices. When they detected movement, they triggered the explosives.

Other than a straight run of electrical wire to a central command post, there are two identical "trip" triggers that work for 99 percent of ambushes. Both are extremely simple, which perhaps explains their effectiveness.

To produce trigger one, strip the insulation from about 6 inches of two ends of number 14 electrical wire. Twist the two bare leads in loose coils around each other, being sure that only bare wire touches insulation and not bare wire to bare wire. Connect one side to a hidden trip wire and place a battery in the circuit to energize it. When the wire is pulled, it will touch bare wire to bare wire, completing the circuit and detonating the device.

Another triggering device involves simply placing a trip wire with a peg in the end to separate the two legs of an electrical circuit wrapped around a spring-type clothespin. When a wire connected to the peg is pulled, the peg will slip out and allow the two jaws of the clothespin to come together, thereby touching the two ends of bare wire together and completing the circuit.

Not all applications for which a survivor might use a claymore can be handled with a trip wire. At gates or on door jams, a simple mouse trap rigged to snap when touched, completing a circuit may be ideal. Yet in most areas where approaches are reasonably observable, it is best to fire remotely via batteries or a generator at a central command post.

As with all devices of this nature, it is imperative to surprise the bad guys with the devices. To the best of my knowledge, this is the first widely circulated set of information on homemade claymores. In that regard, readers are already miles ahead of the competition.

A person who knows the country well can slip around unseen from spot to spot firing

claymores from remote rifle pits. He can observe intruders from afar, taking whatever action is appropriate and necessary. Teamed with hand grenades and mortars, claymores make a somewhat remote retreat impregnable for all but the most-determined, well-trained enemy. In cities, heavy weapons produce situations similar to those in Beirut, wherein certain areas became synonymous with danger. After a few bitter experiences, people just avoid those places.

In the United States, one could conclude that after the first six or eight attempts at storming survivors' retreats, even U.S. marshals would not have the stomach to continue to try to breach these types of defenses.

CHAPTER 35

HOME CONSTRUCTION OF CLAYMORE MINES

I hope readers will not take exception to my mentioning one last time that, like homemade hand grenades and mortars, claymores are possible only if one has the C-4 secret. Other commercial and homemade explosives either do not work at all or work very poorly. With a pound of C-4 made with ammonium nitrate and nitromethane and several pounds of lead or steel balls, claymores are relatively easy to make.

Start the assembly process by purchasing a length of heavy-duty 8-inch PVC waste pipe. Some plumbing shops that do extensive work for municipalities will have scrap ends and pieces to sell at reduced rates. This pipe is very tough yet easily worked and relatively inexpensive, but it is sometimes a bit hard to find. Not all plumbing shops carry it or can order it for you. This pipe measures about 26.5 inches in circumference, including pipe sidewall thickness, which is about 1/4 of an inch.

Measure around the rim of the pipe, laying off the distance in 9-inch increments. This will yield two 9-inch slabs and one that is not quite 9 inches. Using a common wood saw, cut down on the pipe sidewall at the three places marked, a total of 10 inches. Cut these three pieces away from the main body of pipe, yielding three 9-inch by 14-inch somewhat curved pieces of tough, resilient PVC pipe. These pieces constitute the back plates for three claymore antipersonnel mines.

Drill a 1/4-inch hole in the center top of the slab about 1/2 inch down on the 9-inch side.

This is the top of the device. The hole is for use with a nail or wire as a means of mounting in final position for firing.

Drill two 3/8-inch holes along each edge of the 10-inch side of the slab. Put one on top and one on the bottom with about 8 inches separating them. These holes will retain an 18-inch long, 1/4-inch diameter bolt or steel rebar piece, providing legs on which to punch the device into the ground. Weld an old washer to the bolts near the bottom as an aid in pushing the steel legs into the ground. Makers now have two options: they can hang their claymores or they can punch the legs into the ground.

Twist and bend the bolts so that they slip through the 3/8-inch holes that extend solidly below before proceeding to the next step.

Carefully cut the top lip of a 1-quart Ziplock bag measuring 7 inches by 8.5 inches down on each side to just above the plastic bag. Be careful not to puncture the Ziplock bag, as it must be absolutely airtight after being filled and mounted to the PVC slab. The plastic lip exposed by slicing the top of the bag is used as an anchor on which to tape the filled plastic bag.

Fill the plastic bag full of washed ground ammonium nitrate. About 1 pound should be packed into the bag. It is vitally important that the bag be filled bulging full. Regular military-issue claymores contain one pound of C-4. Unless the bag is filled, the powder will not lay flat on the blast shield.

The explosive must lie in an even layer on

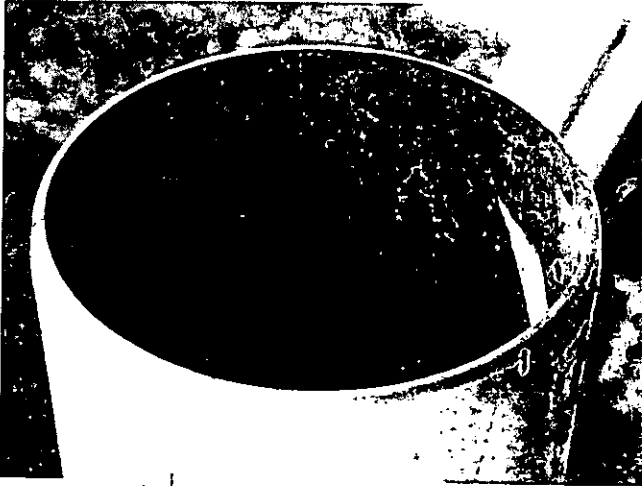

Constructing a claymore by sawing out the back blast shield. Use a 1/3 section of heavy-duty (1/4-inch side wall) PVC pipe. Mark the rim of the pipe off in three equal (9-inch) segments.

the plate when placed in a vertical position. If it slumps to the bottom of the bag, the effectiveness of the device is compromised. Usually this is caused by the bag not being packed full of powdered ammonium nitrate. Keep track of the amount of fertilizer used so that the correct amount of nitromethane can be set aside for eventual inclusion in the Ziplock bag.

Carefully seal up the Ziplock device, and test it thoroughly to be sure it is zipped, locked, and airtight. This step is very important. Many, if not most, Ziplock bags are defective and do not actually seal correctly.

Use heavy-duty 1-inch wide fiberglass packing tape to attach the top lip of the filled Ziplock bag to the top of the PVC plate. Run a line of tape down the side of the bag as well as along the bottom. Before setting the plate and attached explosives upright (vertical), run two more very tight strips of tape over the face of the bag. They should be placed so as to keep the explosive in the bag from settling down or sagging. In all cases, keep the layer of powder packed as flat as possible on the PVC plate.

Be careful that you do not permanently seal the bag with tape; you must still add the nitromethane when you are ready to use the claymore. I leave two small lips of the Ziplock untaped so the liquid can be added in two places.

Government-issue claymores contain

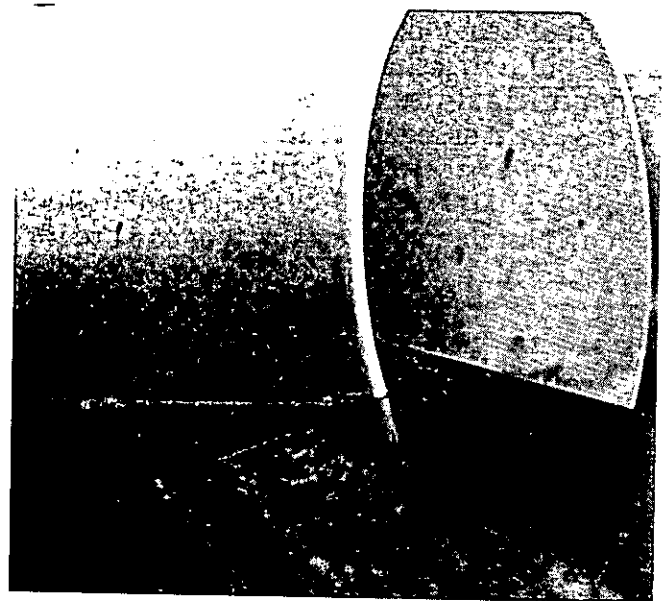
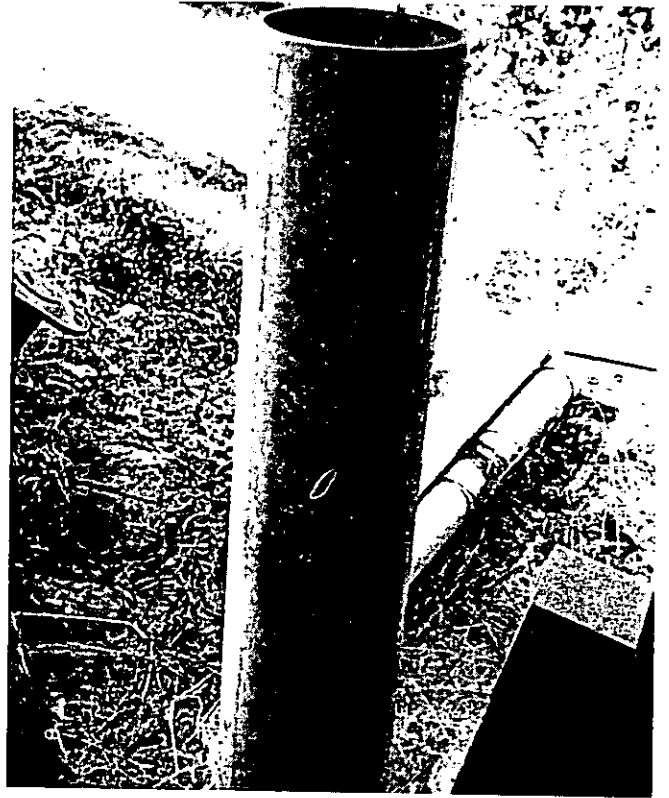

Using a common hand saw, cut straight down from the marks, producing three almost equal 9- x 10-inch slabs of PVC pipe.

approximately 700 .38-caliber hardened-steel balls imbedded in 1 pound of puttylike C-4. Hardened steel is used because it is cheaper

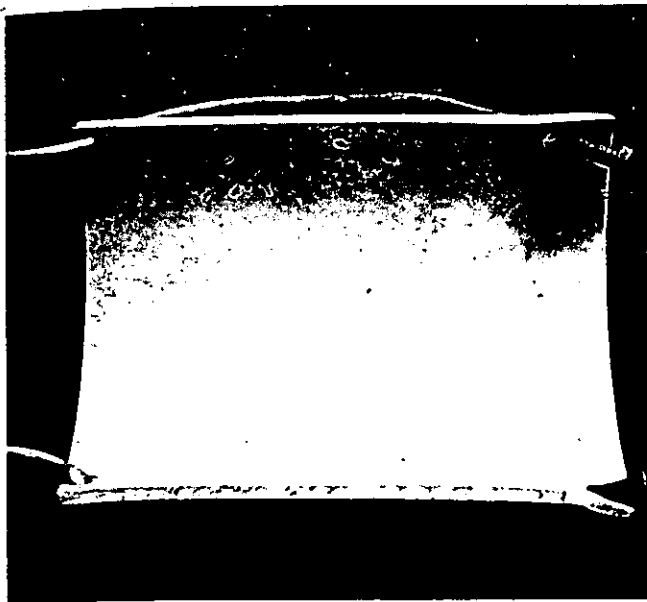

Drill 3/8-inch holes in the corners of the slab along the 10-inch side. Thread 1/4-inch bolts or rebar through the slab to be used later as legs on which to mount the device.

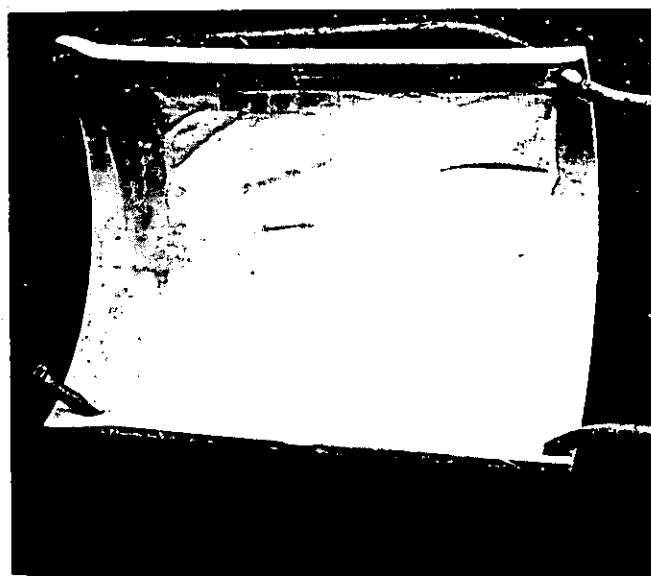
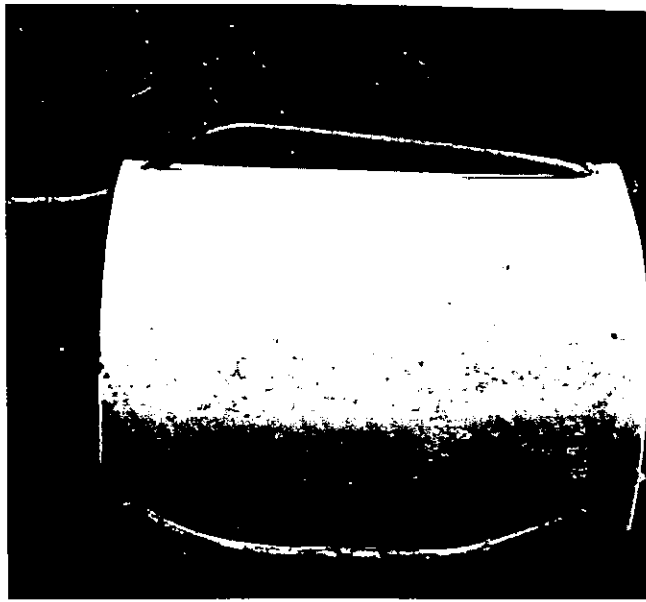

Pack a 1-quart Ziplock bag full of washed ground ammonium nitrate. Secure the bag in as flat a manner as possible to the PVC slab. Do not allow the powder to slump to one end of the bag or the other. Secure it with sticky packing tape.

and more reliable than lead, which can deform at the blast and fly off erratically. Claymore projectiles do not have to travel down a barrel that quickly wears out, allowing the use of steel.

Hardened-steel balls are marginally more

effective against vehicles—another reason they are used in commercial designs. As a rule, any round lead, iron, or steel ball from .28 to .45 caliber will work. Home builders generally report that securing enough suitable, reasonably priced projectiles is one of the most challenging aspects of this project.

Generally, it is better to use more easily obtained 00 or other buckshot that can be purchased at most full-service sporting goods stores. Double 0 buck is .34 inches in diameter. There are about 98 to the pound. Theoretical maximum range is 685 meters. Practical range in homebuilt claymores seems to be about 35 to 50 meters, although I wouldn't knowingly stand in front of one 200 yards out.

Seven hundred rounds of most effective lead buckshot sizes weigh 4 to 6 pounds. That and explosives produce a device weighing close to 8 pounds, far more than commercial claymores and probably larger than needed by most survivors.

I have discovered that about 3 pounds of projectiles or about 300 to 400 pellets work well in front of our 1-pound C-4 pack. Although results on actual live targets are still questionable, the load appears to be effective. It will hack down brush about 35 meters away

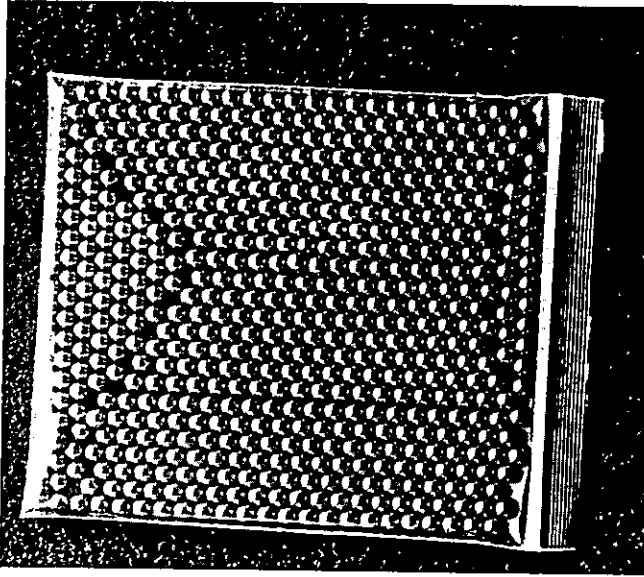

Approximately 3 pounds of .30-caliber steel ball bearings packed tightly into a Ziplock bag. These projectiles must be placed one deep in an even layer over the explosive.

in a very laudatory fashion. Given the slight concave configuration of the PVC panel, concentration of pellets seems very nice.

Easily the most difficult mechanical task in building a claymore is setting the lead or steel balls in place. The resulting layer of projectiles must completely and evenly cover the explosive packet without major gaps in spacing and without laying them two deep in some places. This layer of projectiles must lie vertically, tightly on the explosive.

Pellets used in commercial models are physically pressed into the puttylike C-4. In the case of homebuilt claymores, this is not possible.

My first trial many years ago involved stringing number 4 split-shot fishing sinkers on weak monofilament line. Eventually I wove these over the explosive, covering it completely. It was an operationally successful plan, but it was extremely tedious and expensive to set up and supply.

The best plan involves placing just enough projectiles in a 7-inch by 8.5-inch quart Ziplock bag to fill it with no holes or gaps but not allowing the projectiles to pile up in any one place. Having created a smooth, flat packet of projectiles, lay two pieces of stiff cardboard on front and back of the Ziplock packet.

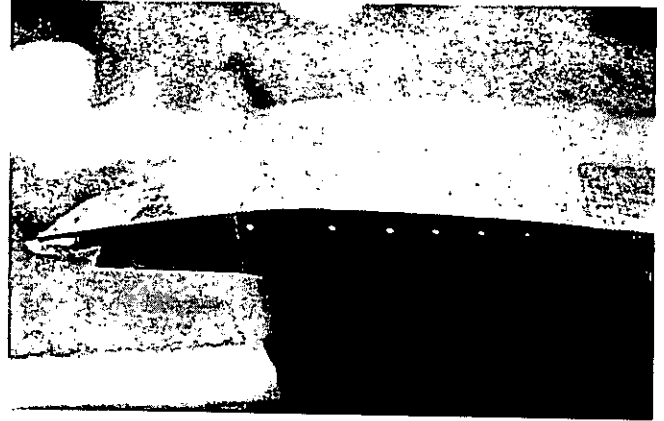

Projectiles secured in a sandwich of thin cardboard.

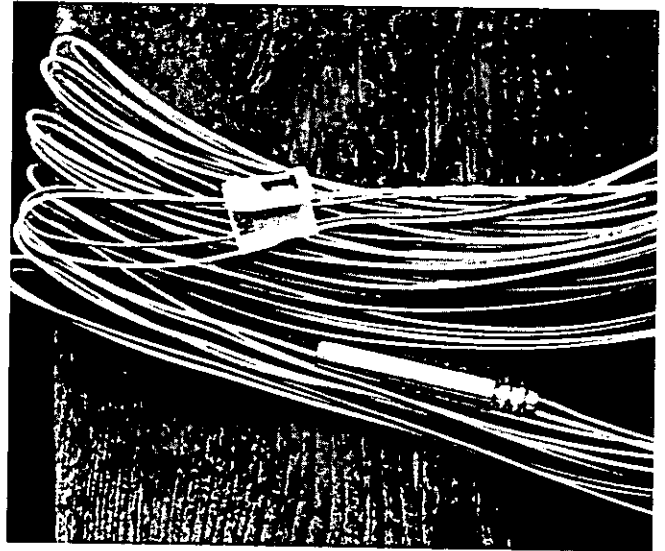

Standard number 8 electric blasting cap.

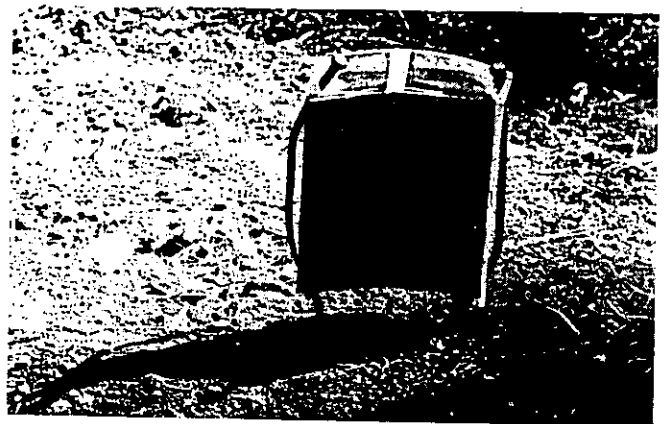

Finished claymore with projectiles taped firmly in place and electric primer in place.

Building and Keeping Your Arsenal Secure

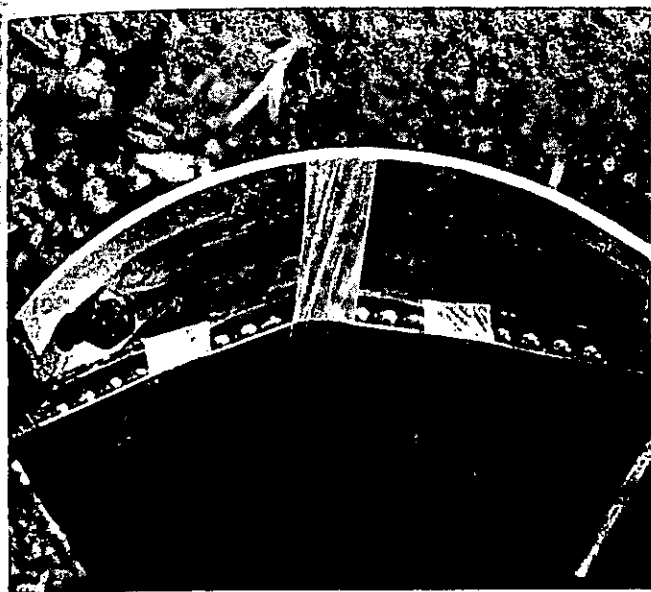

Top view showing projectiles and electrical blasting cap.



View of the back of the claymore. Be extremely careful of the back blast on these devices, which is severe.

Tape these together rigidly, still holding the shot in a flat, smooth configuration.

Using supersticky packing tape, seal the packet of buckshot flat and tight against the explosive. Again, be careful to leave access into the powdered ammonium nitrate.

When ready to use, it is much easier to use a small funnel with a short segment of rubber hose attached to pour the nitromethane into the inner packet. We probe the bag open with a small, wooden rod. Presence of many layers of thick, tough tape can make this far more difficult than one would initially suspect.

Prime the device using a standard num-

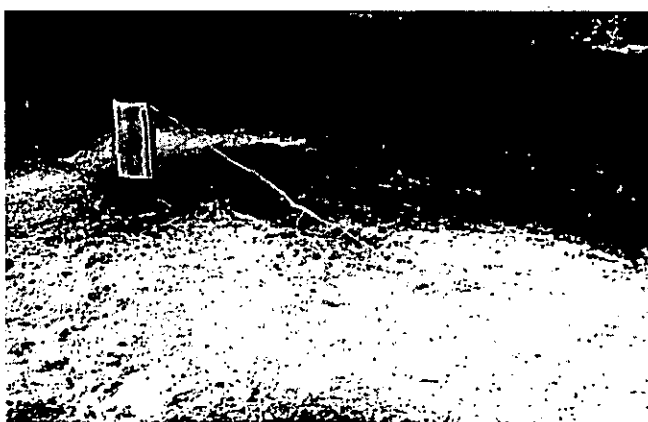

Claymore guards path. In a real situation, the user would have hidden the electrical lines to the device.

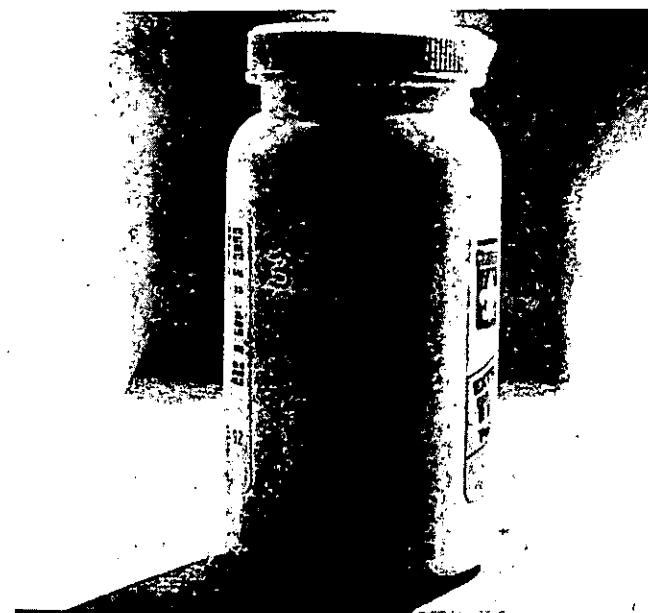

Coded bottle containing the correct amount of nitromethane for each device is stored with the mines.

ber 8 electrical detonating cap. I sometimes glue a 1-inch piece of 50-grain primer cord to the cap as a booster. Conventional wisdom suggests this is not necessary, but it is good insurance.

Place the device where it will do the most good, push the cap down inside the explosive, attach drop wires and one leg of the battery, and it's show time. Given enough time and thought, I intend to rig my devices with both a remote- and trip-detonating system.

Field life is probably several months or more, although I don't know that with certainty. The maximum time I have kept charged claymores is about four days.

These claymores really speak up when going off. Keep out of the blast and, of course, do not underestimate their forward or rearward range. Be extremely cautious. Homebuilt claymores are for desperate people in desperate circumstances who have taken the time to learn to handle high explosives.

CHAPTER 36

INTRODUCTION

Weapons caching has been an important strategy in at least two of the major wars fought in the past fifty years.

Initially, it may seem strange to view weapons caching as having a significant impact on World War II, but in the case of occupied France from 1940 to 1944, the willingness and ability of the French Resistance to take delivery of weapons, move them around the country, and then safely store them against the day of need contributed in part to the defeat of the Nazis. Although the Resistance efforts were considered by many to be relatively puny (they used only three thousand pounds of C-4 for their entire operation, less than one good-sized bomb from a B-24 Liberator), they were more effective at sabotaging the Nazi war effort by stopping the production and flow of munitions than the entire bomber command, and inadvertent civilian casualties from Resistance activities were very light.

The Resistance organized very quickly after the occupation of France in June 1940. Because the French, like the English, had little history of private firearm ownership, there were few weapons on hand with which to commence action. (Historical records show that some farmers had shotguns, but virtually none owned pistols or rifles legally.) The first British agent into Paris radioed back that they had "but two revolvers and two rifles." This appraisal may not have been entirely accurate, but it was the one accepted by the English.

Initially, only the French Communists were organized enough to carry out a credible program of opposition to the Germans. (Some historians downplay their role, but it was the Communists against the Fascists, and the United States supported the Communists.)

Some thirty years later, the United States lost in Vietnam, in part because of the elaborate, careful, weapons caches set up in patient, thorough, oriental fashion by the Vietnamese. Like the Resistance in World War II, the able, careful Vietcong made great use of weapons caches to defeat an opponent that thought itself smarter, better organized, and more technologically advanced.

Correlations between the Vietcong, who were Stalinist Communists, and members of the French Resistance, who were more Trotsky-like, are perhaps coincidental; at the very least the link is ironic. Nevertheless, like the French before them, burying weapons was, for the Vietnamese, a key tactical strategy. Each time they suffered reversal, their weapons went safely underground, beneath flooded rice paddies, or into the swamps.

Weapons caching technologies have changed dramatically since World War II. Methods of resealing containers and evacuating moisture have advanced to the point that technological problems are no longer a consideration. Caching difficulties with which the French Resistance labored mightily can be handled today without much thought as to

what we would do without inexpensive plastic pipe, fittings, moisture-absorbing chemicals, and modern greases.

The Resistance had to work with heavy, clumsy, shiny aluminum tubing that cracked, corroded, leaked, and bent out of shape, creating almost insurmountable opening and reclosing problems. Modern plastic pipe and fittings found in plumbing supply shops alleviate these problems to a large extent. Like its aluminum predecessor, most plastic pipe is so tough it can be dropped out of a plane.

Because technologies related to locating a cache have also made quantum leaps, the person whose strategy includes weapons caching must now spend more time and energy deciding where to place a cache. This is in contrast to World War II, when the Resistance had to give as much thought to

how the cache would be built as to where it would be placed.

Based upon the great emphasis some law enforcement people place on thoroughly searching a suspect's home, yard, and grounds with sensitive electronic devices, official searchers and seekers appear to have identified weapons caching as a particularly threatening activity. These officials have learned the lessons of history better than average citizens suspect.

Americans in Vietnam knew the Vietcong were getting weapons from irregular caches, and they learned that they needed to locate these caches whenever possible. Today many Americans realize the United States is in a race against firearms confiscation in which the lessons of the past will play a significant role. This book is dedicated to those who wish to look to the future with both mistrust and a will to prevail.

CHAPTER 37

CACHING AND YOU

Ray Wilson travels often on business to Washington, D.C. As a professional geologist, he feels it is important to keep in touch with members of his profession in the National Geological Survey Office. Taxpayers cover his travel expenses, so Dr. Wilson can think of no valid monetary reason for not taking the trips as often as possible.

On one such trip several years back, Wilson, the admittedly small-town boy, decided to stop at a drugstore on Wisconsin Avenue, in the heart of Georgetown, at about 10:00 p.m. On his way into the store from the public sidewalk, he found it necessary to wade through a number of D.C.'s finest, most persistent, obnoxious panhandlers. Being from a part of the western United States where these sorts of people virtually do not exist, Wilson was not equipped to deal with the situation in which he found himself.

Sensing his fear, the moochers pressed him vigorously, ignoring other potential donors. Two of them stood together in the middle of the sidewalk, effectively blocking his way into the store. Somehow these people felt Wilson owed them money, a claim they pressed even more vocally and physically when they realized he was uncertain about the situation. Once inside the store, the now very shaken Wilson tried to persuade the store manager that he had been the victim of a rough, dangerous encounter. He pleaded with the manager to call the police.

"They won't respond even if I do call," the manager explained patiently. "What are you, some kind of hick? District police only look into holdups of more than five hundred dollars, shootings, or major drug deals."

"But I can't go back out there again," Wilson pleaded passionately. "They will tear me to pieces."

"If they do tear you to pieces, then the police will investigate, but I suggest you wait here for fifteen or twenty minutes and then leave with several other customers," the manager persisted.

Finally that's what he did. Wilson walked out of the store with a group of Washington natives who knew how to deal with panhandlers. On the way back to his hotel room, Wilson vowed never to let such an incident happen again. Lesser people might have settled for a relatively wimpy can of tear gas or some similar device, but not Wilson. He was an exploration geologist, accustomed to wild and wooly situations.

I got involved when Wilson asked me to sell him a small handgun. In the course of the sale, he told me about the incident in Georgetown and explained how he planned to deal with this sort of thing in the future. It was interesting to keep track of events as they unfolded.

When Wilson flew into our nation's capital, he always went through National Airport. From there he took a taxi directly to the Key

Bridge Marriott where, for reasons of access, cost, and comfort, he liked to stay. Washington, D.C., is packed full of hotels, but for those who have not stayed there, the Key Bridge Marriott is characterized by larger than normal gardens and sundry strips of shrubbery, many of which are inside the hotel along various courts and walks that are out of sight from any but those few guests who use them.

At the time this incident occurred, the airlines did not fluoroscope or otherwise examine checked baggage to any great extent. Wilson put his pistol and a box of ammo in his suitcase and sent it on through to National Airport. As was his custom, he stayed at the same Marriott outside of Georgetown.

However, this time Wilson retrieved the pistol from his suitcase and carried it with him in an ankle holster as he went about his business in D.C. He knew which buildings were protected by metal detectors, so he would leave the pistol in his briefcase with a security officer when he went through a security system.

When ready to leave the city, Wilson inspected the two clips, wrapped the pistol and ammo in rust-inhibiting paper, and sealed both in quality plastic bags he had purchased just for this occasion. After sealing up the bags, he buried them about twelve inches deep in one of the Marriott flower beds. He picked a place where there was a distinctive mark on the wall to facilitate finding his cache the next time he came to D.C.

Whenever Wilson arrives in D.C. now, he simply retrieves his piece, performs any necessary cleaning, and goes about Washington equal to any three muggers. Today, Wilson maintains significantly increased peace of mind while moving around from place to place in the big city. (Someday a Bernard Goetz-type incident may occur, and Mr. Wilson will fault me for putting his account in print.)

By caching in a common area such as a flower bed, Wilson does not have to worry about requesting the same room in the Marriott every time he comes to town. Above-ground locations might work, but the chances of having his pistol discovered in the course of

routine maintenance or repair would be much greater.

Recently, airline search procedures have become more sophisticated. Today, Wilson might not get away with carrying a pistol through in checked baggage. In all probability, he would have to smuggle a pistol in using a private automobile or public ground transportation, such as a bus or train. Since he launched his personal protection program, virtually every criminal in Washington, D.C.—probably some panhandlers included—has upgraded his weapons. Wilson believes that anyone without a sidearm in that city is at a real disadvantage.

Caching a pistol in crime-plagued Washington, D.C., is an excellent example of a modern-day self-defense strategy. In the burgeoning struggle for survival, this is one practical application for caching that may be useful to a number of citizens. But it is only one of several.

INVESTMENT

Back in the mid-'30s, when the Federal Firearms Act was enacted, a close friend who happened to be the sheriff in Tippecanoe County, Indiana, bought three 1928 Navy-model Thompson submachine guns for private use. Because of the new law, popular opinion held that these sort of guns were just about worthless. He purchased them for thirty dollars apiece. He coated the guns with grease inside and out, put them in a rough box built of heavy cyprus planks, and buried them in the ground for long-term storage.

Because of the limited technology of that era, he found he had to dig the Thompsons up from time to time to be sure they remained in good shape. They kept well over the years, due largely to the ideal location in which he chose to place the cache. Tippecanoe County is characterized by well-drained, sandy soil. By avoiding swamps and bog holes, he was able to keep the weapons absolutely rust-free until the time came to sell them.

My friend the sheriff retired in 1958, and

Building and Keeping Your Arsenal Secure

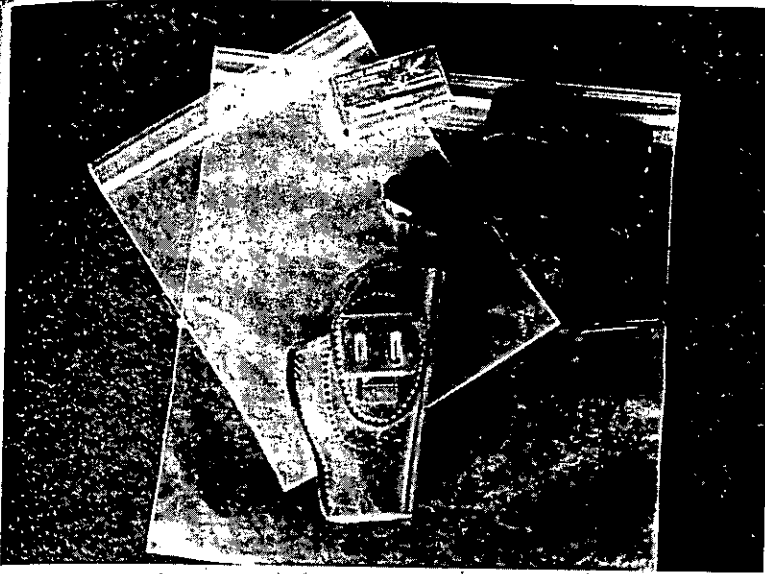

This Walther PPK with extra magazines and a box of ammo has been buried in a flower bed at a Washington, D.C., hotel for nearly fifteen years. The owner carries the weapon for protection whenever he does business in the capital city.



Walther PPK double-bagged for burial.

his wife contracted cancer in early 1964. He dug the weapons up for the last time and took them to town to sell. As it worked out, they were an excellent investment for the man, having appreciated many times over. He secured top dollar for weapons that were virtually unavailable from any other source.

In this instance, weapons caching went beyond being a self-preservation plan and

became a valid investment strategy. Should semiautomatic weapons—including so-called assault rifles—suddenly be banned, those who have them and are willing and able to put them in the ground for a few years will later find their investment has doubled or tripled. Already we have seen common AK-47s and AR-15s go from a little over four hundred dollars to a thousand dollars or more.

Ammo is an excellent item to consider when looking at investment caching. It keeps as well or better in a cache than weapons, and because it is consumed rapidly under some circumstances, it is not nearly as easily replaced as one might initially suppose. Gun nuts who are accustomed to popping down to the local gun shop for a fresh supply of powder, bullets, or loaded rounds should give this concept some serious thought.

Early in the surplus military weapons era I purchased two million rounds of ammo on behalf of a firearms shop for which I worked. The lot included 9mm Parabellum, 8mm Japanese pistol, 7.62mm NATO, 8mm Lebel, 8mm Mauser, 6.5 x 55 Swedish Mauser, and some 6.5 x 54R Dutch ammo. We paid two cents per round on the average, and I was certain we would never get our forty thousand dollars back out of the deal, much less turn a profit. However, when surplus weapons started to sell in large numbers, we priced most of the calibers at ten dollars per hundred rounds for the first six months, then twelve dollars and fifteen dollars until it was all sold.

Some calibers sold better than others, but we made excellent money on the entire lot. It was only one of many lots of ammo we purchased for resale. Through the years we always scraped together enough cash to purchase any odd or surplus ammo available. At one time, we had at least \$100,000 tied up in

.25-, .32-, and .41-caliber rimfire ammo as well as less exotic numbers such as .303 Savage, 6mm Lee Navy, .25-20 single shot, .30 Remington, .33 Winchester, and many others.

Right now, while cheap surplus ammo is still available, I might suggest that it would be a "no-brainer" to buy up a large supply of the more commonly used calibers and put it underground until the time when it becomes scarce. Ammo virtually never goes down in price.

In my personal cache, I have some surplus 8mm Mauser ammo, manufactured in Turkey in 1914, which was originally part of a two-million-round order placed in 1962. It came to us in sealed cans. Other than the small amount I blasted away for fun, I left the ammo in the sealed containers and resealed it in cache tubes. Now, more than seventy-five years after its manufacture, the ammo still fires reasonably well. About one round in fifty will not fire, but since it is mostly blasting ammo manufactured under questionable circumstances, I don't consider this to be an insurmountable problem.

PERSONAL PROTECTION

Weapons can be cached for isolated circumstances when personal safety is threatened and a sure method of self-defense is needed to provide peace of mind, and they can also be cached for investment purposes. But for most people, weapons caching provides safe, long-term storage of their best means of personal protection.

As laws change and rules are promulgated by state and national legislators, the need for caching may become especially pressing. Citizens of California and New Jersey who wish to remain at least on an equity base with criminals, or who have expensive guns they do not wish to throw onto an uncertain market, are already victims of a force that may be a harbinger of things to come throughout this nation.

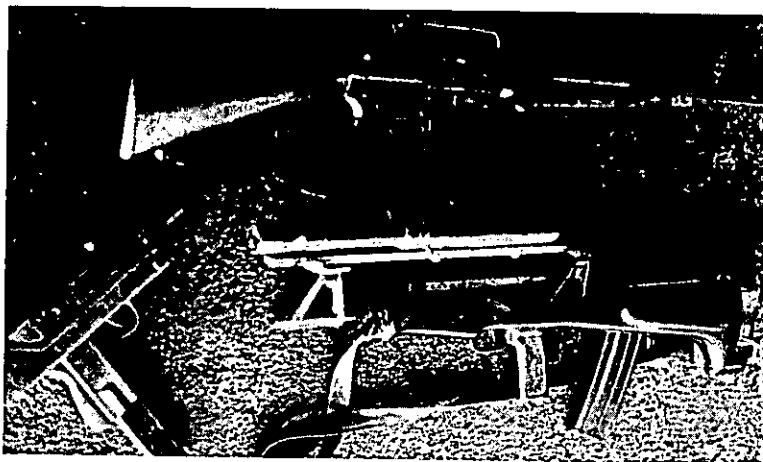

Burying your semiautos now, before they are banned, goes beyond self-defense or self-preservation. It is a valid financial investment strategy.

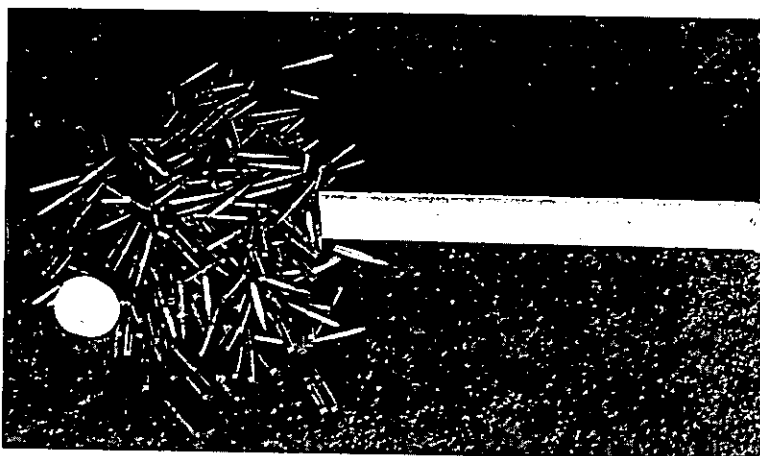

Cache ammunition in smaller tubes alongside your weapons. Since ammo rarely, if ever, decreases in value, it is a good investment. And it may not always be as freely available as it is today.

In other places, gun nuts with large collections of guns and ammo may be victims of this force as well. A law-abiding gun owner may thwart the robbery of his home, only to be harassed unmercifully by the media. Who wants to read about himself in the paper—**"Local man found with dozens of guns, thousands of rounds of ammo."** No matter that there were only nine guns and that three were single-shot 410s that you bought for your kids and that "thousands of rounds" is only four or five cartons of 22s all purchased at a dollar per box. The media will fry gun owners if they get any chance at all. Just the fact that

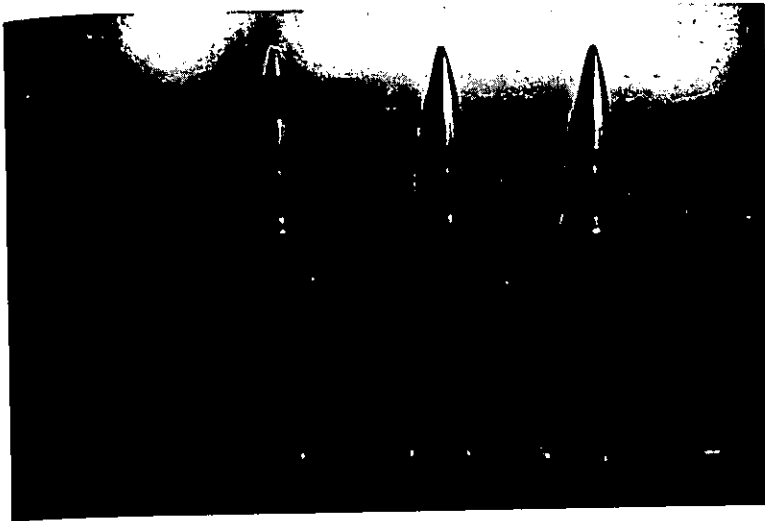

These 8mm Mauser rounds, made in 1914, have been cached since 1964. Despite the corrosion seen on the left round, only one in fifty fails to fire.

a gun nut has several weapons and more than a handful of ammo is more than enough cause for the media to come down very hard on him. Though our hobby constitutes no threat to anyone except criminals, every gun owner is held in contempt and suspicion.

Gun owners who foresee themselves in these types of uncomfortable circumstances may wish to consider caching all of the weapons they do not plan to use on a frequent basis. Those who do it now, under relatively easy, unpressured circumstances, may be the real winners in the long run. They will have enough time to think through their caching program adequately so that they can do it right.

Most really clever, innovative cachers require time to develop their programs. Especially for city dwellers with few burying options, caching done under duress is never as good as long-term plans that may involve some sophisticated masonry or carpenter work involving rerouting water pipes and so on.

Many inner-city gun owners fear that possessing weapons will, ironically, single them out as targets for common criminals (as opposed to official criminals), who either want weapons for their own use or know where they can sell all the quality weapons and ammo they can steal to people with all the money to buy them. Preventing your weapons from being stolen is another reason for caching, and it is a worthy one.

You can build clever hides that allow you to look at your weapons from time to time. You may still wish to tape a box of ammo to the bottom of a dresser drawer or the lid of the toilet tank, but putting the bulk of your guns in a good cache now, when the time is available to do it right—before the thieves break in and while personal protection is still an option—may be the smartest decision you, as a prudent gun owner, can make. If nothing else, your cache can be viewed as an investment that will pay great dividends in one way or another.

CHAPTER 38

MODERN CACHING TECHNOLOGY

Since World War II, remarkable new advances in caching technology have drastically altered almost every aspect of strategic weapons storage. Caching equivalents to atomic warfare make it possible to hide weapons under virtually any environmental circumstance. It is now possible to store your guns in a sewer, a lake, a running stream, a vat of acid, a freezer, a chimney, or a host of similar places that the bad guys are either unlikely or unwilling to think about. This is the good news.

The bad news is that the other side also has some fantastic new technology to work with. Some of the space-age gizmos they use are so good that the cacher must use all of his wit and intellect to keep the cache intact. It's the age-old rule of measure and countermeasure, of technology ratcheting each side up in a kind of lock step. Yet the new technology we have presents opportunities unheard of even a few years ago. It would, for instance, be advisable under some circumstances to place your cache tube inside a furnace closure next to a firebox after wrapping it in a space blanket. There are many other locations around the home or farm and at the workplace where the bad guys either will not look or will be reluctant to search thoroughly. A farm silo or the bottom of a large granary are excellent choices. It would take weeks and tens of thousands of dollars for searchers to empty these bins on the outside chance that they might contain a

cache. In the case of a silo, it might be dangerous for the authorities to search it because of dangerous gases produced inside.

However, septic tanks and sewers, which appear at first to offer some of the most interesting possibilities, do not in reality have much to recommend them. Recently, the DEA, FBI, and federal marshals have pumped virtually every septic tank they encountered at places in the country where they were searching for drugs or munitions. It has been just about their first order of business when searching for contraband. Perhaps it is a logical extension of the Nazi experience of uncovering caches in refuse containers, but at this point it seems like good advice not to cache in septic tanks or garbage receptacles. Bomb squads look first into garbage cans and wastebaskets, leaving one to conclude these sorts of locations are not particularly secure.

For the purposes of this analysis, one must assume that there is a great difference between large weapons caches and hiding a weapon or two in your apartment. Subsequent chapters will cover hiding personal weapons. Many caching and hiding techniques are similar, but there is a difference—in psychology if not mechanics. To be successful, the cacher must understand this and be able to distinguish between the two.

Modern caching techniques are not particularly difficult when viewed in their component parts. The techniques can be exacting but

are not difficult to master. Sloppy execution will lead to poor results, while the opposite is certainly true—careful execution will lead to excellent results.

My first experience with a weapons cache was much the same as that of the sheriff from Tippecanoe County. It was a long time ago, but as I remember, we took a GI-surplus wooden box that once housed three 3.5-inch bazooka rockets, disassembled our weapons, stacked the various parts neatly in the box, and filled it up with molten grease. We purchased the grease from a farm supply store in five-gallon pails. I believe it took two full pails to cover everything completely.

We removed the wooden stocks from the weapons and stored them in another location. Wood will deteriorate in grease much faster than steel, we reasoned, but this was not a particularly wise decision. Anyone who noticed the stocks would have suspected a nefarious weapon or two might be lurking somewhere near as well. Modern military weapons are seldom constructed using wooden stocks, but not all of us have the privilege of caching the most modern weapons. Some citizens, for instance, may feel harassed to the point that they simply wish to cache a superaccurate bolt action rifle. Today I would leave the wood with the metal, assuming that both will last a minimum of twenty years in an airtight container.

Another problem we had with storing the parts separately was that some of the pieces were misplaced. After a time, we didn't know for sure if they were in one cache or another. On one occasion we returned to a cache after a great number of years only to discover that a key part was irretrievably lost. From then on, only complete weapons packages went into a single cache.

Even in a military context, disassembling a weapon to save space may not be a particularly good idea. Unless the disassembly is very basic, small parts may be misplaced or hidden in the grease coating. Removing the stock from a Thompson or splitting a Schmeisser in

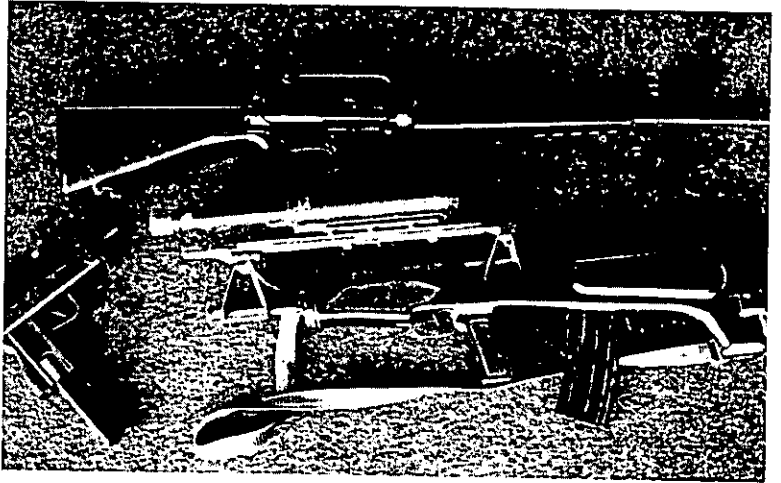

Since many military-type weapons have limited amounts of wood to deteriorate, they tend to store well. The laser sight must be removed and placed in a smaller cache tube.

half, for instance, might be okay, but removing a scope from a rifle to be cached is often of questionable value (although sometimes it must be done).

How does one reassemble and rezero a previously cached rifle with its scope? Test-firing semiautomatic weapons attracts quite a lot of attention. Rezeroing a scoped rifle over larger distances may be out of the question for some city dwellers. (Maybe that's why the hero in many spy stories is never successfully shot by the villain sniper.) In occupied France, the situation became so tough that replacements for fallen Resistance members could not be trained with firearms. They simply had no place to practice or to sight-in weapons. This situation may seem unlikely in the United States, but I'll bet few owners will be taking their semiautos to the range to practice in California.

Modern caching equipment roughly breaks down into the following essential categories.

PLASTIC CONTAINER

Since most caches are placed in the ground in a vertical position, it is best to use standard round plastic plumbing pipe. Purchasing sections of pipe from the local plumber will not be a problem since they sell dozens of similar



Installing the end cap on a four-inch cache tube. Most cachers find that four-inch tubes are too small for anything except ammunition and magazines.



A new sixty-inch section of eight-inch cache tube, ready to be filled with weapons.

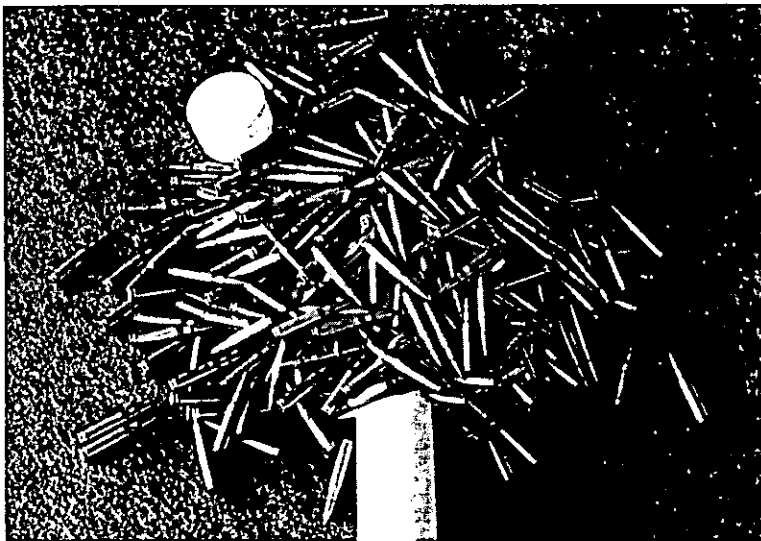

A four-inch cache tube will hold a tremendous quantity of ammunition.

items to hundreds of people each day. When the Bureau of Alcohol, Tobacco and Firearms (BATF) people inquire, the clerk will have no recollection of what you purchased. If a question does come up, tell the people at the plumbing shop that you intend to construct a map tube or a fishing pole holder.

Cache tubes must always be placed in the ground vertically. Horizontal tubes expose too

much surface area to sensitive metal detectors. Always bury the tube so the top is at least one foot below the surface.

Many army/navy surplus stores carry polyurethane plastic barrels about the size of fifty-five-gallon steel drums that are intended for caching. They are thick and tough with an adequate screw-type lid through which most weapons could be passed. Though these barrels are fine for caching food and medicine, they are not recommended for weapons. Their overall width, plus the huge mass of steel they might contain, make them extremely easy targets for modern metal detectors.

Use the four-, six-, or eight-inch diameter SDR (Sanitary, Drain, Refuse) pipe found at virtually any full-service plumbing shop. There is a lightweight and a heavy grade of four-inch pipe. Use only the heavyweight material if a four-inch cache tube is adequate. Six- and eight-inch tubing come only in heavy

and extra-heavy grades. Inexperienced cachers will try to get by on smaller tubes initially because they are easier to find and much cheaper, but almost everyone eventually uses eight-inch pipe for their cache tubes. There is a high-pressure, eight-inch plastic pipe called a "blue boot," but it far exceeds the needs—and perhaps the pocketbook—of most cachers. The wall thickness on blue boot pipe is almost three-quarters of an inch.

A section of eight-inch plastic pipe will hold quite a load of weapons. Count on placing at least two full-sized rifles, four assault rifles, four or five pistols, and dozens of magazines in a single eight-inch tube. (Enough, my friends claim, to start a revolution in Central America.)

It is best to have the tube cut at a length of sixty inches. This way, even the longest semi-automatic weapons will fit inside the tube, and the parts will have an opportunity to settle into the lower end, farther from the probing eye of a metal detector.

Heavy-duty, four-inch SDR pipe retails for about \$.95 per foot, six-inch pipe for about \$1.55, and eight-inch,

the most common cache tube size, for about \$4.15. Some small stores must special-order eight-inch pipe and will want you to purchase an entire ten-foot section.

Various threaded plugs can be purchased for the tubes, but usually the best and cheapest are simple slip-on end caps. Threaded fittings are theoretically easier to get into and more secure, but this is not always true out in the field. Threaded caps clog with dirt and are often as difficult as slip caps to remove. They are no more impervious to water under most circumstances than a simple, inexpensive grease-sealed end cap.

Plain end caps for four-inch pipe cost about

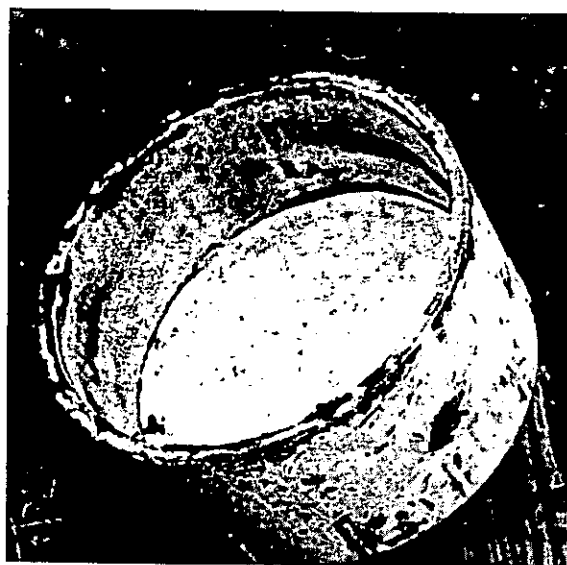

Common eight-inch slip-type end cap used with a grease closure on a cache tube.

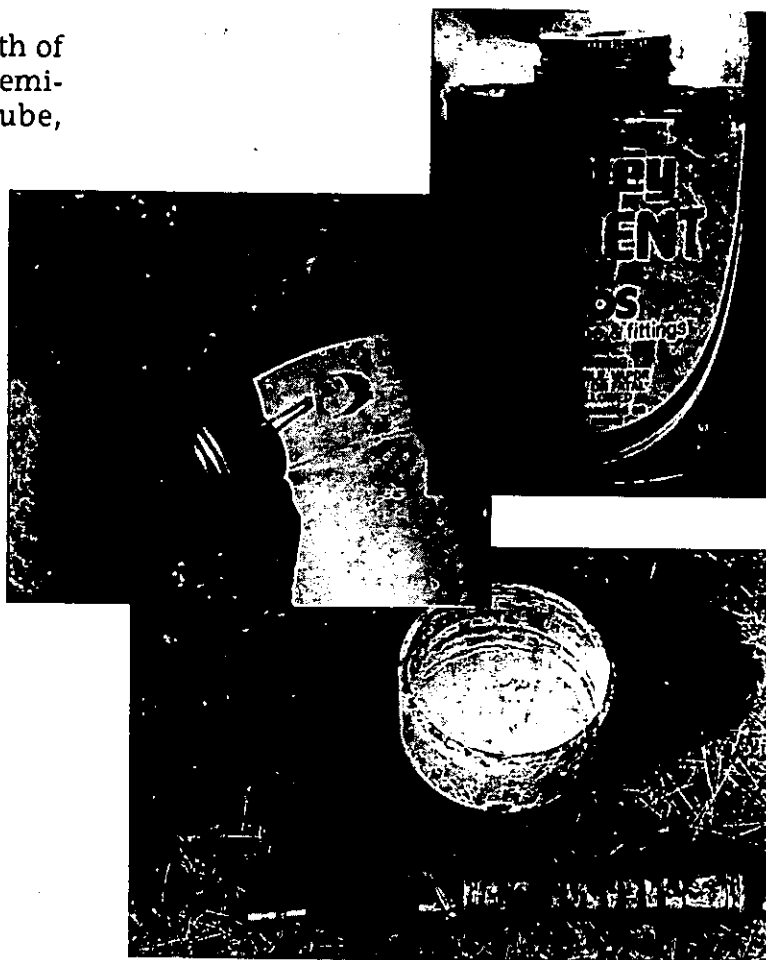

Top Left: Permanently glue the lower cap on the cache tube using ABS cement purchased from a plumbing supply house. Top Right: ABS cement used to attach caps to cache tubes. Bottom: Eight-inch slip-type cap for cache tube with grease gun used to attach cap.



A hand grease gun is used to apply common lube grease to the end of an eight-inch cache tube prior to placement of the end cap.



Grease sealant being applied to the inside of the end cap.

\$1.50, six-inch caps \$6.90, and eight-inch slip caps \$21. Female adapters into which a plug could be threaded cost roughly \$5.25 for a four-inch pipe, \$16.20 for a six-inch pipe, and are not even made for eight-inch pipe. Plugs for the two available sizes are \$2 and \$5 each.

Whatever closure system you choose, you will cement one cap on the lower end of your cache tube permanently. There is no reason to install expensive fittings on the end of a pipe that will be in the ground. Use heavy pump grease to coat the end of the pipe and the cap on the top access end. After you've glued the bottom cap on, you can check the seal to determine whether the tube will hold pressure by pushing a cap onto the top end. If there is a leak, the cap will pop off the top of the tube right away. If it is a good seal, air pressure will build up in the tube, preventing the cap from settling on the end of the pipe initially, but once the air pressure equalizes, you'll be able to push it on. (If the cap absolutely cannot be pushed on the tube because of the air pressure, drill a small hole in the cap to allow the trapped air to escape. Pressurizing the tube provides an additional barrier against moisture. Do not drill a hole to relieve this pressure unless it is absolutely necessary.) At times it is very difficult to pry these pressurized caps off the tubes once they equalize and "set up." I use a small hammer to tap them off or a piece of two-by-four as a pry. Some cachers use standard PVC glue to place a small handle on the cap so it can be pulled and rotated to open.

If you feel you must remove the scope from a rifle to be cached, it is always best to place it in its own internal plastic pipe container. This isn't the best situation, but it is way ahead of anything else if you must cache a scoped rifle.

For all practical purposes, these sealed plastic tubes are impervious to the elements. Whatever is stored in them today would certainly emerge in fine shape if dug up in the year 2001. If you are positive the cache will remain in place ten years or more, it is advisable to seal both ends. In this case, if you

wanted to use the enclosed weapons in the year 2001, you would have to saw the pipe open with a carpenter's saw.

RUST-PREVENTATIVE COATING

Treating weapons that are stored within an airtight cache tube is a matter of some debate among the caching fraternity. Most cachers agree that it is best to coat them with either regular grease or special oil made to prevent rust and other deterioration. Some simply cache their weapons as they came off the rack.

Conoco makes a product called "Cotton-Pickers Spindle Grease," a special rust preventative that protects metal parts as well as or better than anything else around. The product is a thin grease, almost liquid at room temperature. It sells for about twenty-five dollars per five-gallon pail. In most sections of the country it would be necessary to special order it from a local petroleum products distributor.

Metal parts on weapons can be coated with this material, and while it does not harm wood in the short or intermediate run, it may deteriorate it after very prolonged storage. The grease is thin enough that it may all run off into the bottom of the tube if the ground warms a bit. Apparently, enough would remain to control rust for at least ten to fifteen years.

Cachers can also use the less exotic technique of applying a thin coating of regular lube grease to their weapons. The coating can be as thick or thin as one feels is appropriate. Some surplus shops still have the odd bucket of inexpensive Cosmoline around. This material, if one can find it, will do the job very nicely. Expect to pay about seventy-five cents to a dollar per pound for grease and about thirty-five cents a pound for surplus Cosmoline.

Invariably, the question arises—why not pour the tube solid with grease? It can be done, but it is a very expensive procedure.



Placing slip cap onto cache tube.

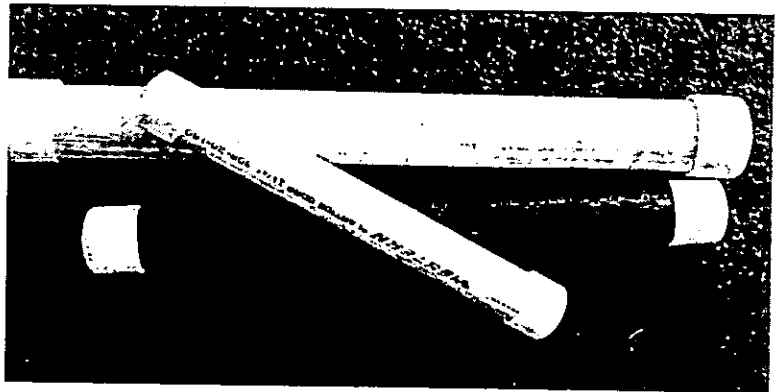

Smaller 1 1/4-inch, 1 1/2-inch, and 2-inch cache tubes with slip-type end caps. These are useful for storing scopes, ammo, laser sights, and other small parts within the full-size tube.

While it is also very effective, it probably is not as effective as blister packing (covered in another chapter). Also, solid-packed cache tubes are so heavy that it is difficult to carry them to their burying place, and it is impossible to remove or inspect the weapons in the tube once cached. Still, caches under these circumstances are extremely stable. There is no way of knowing, but I suspect the contents would remain in good shape for at least a thousand years. If the cap were sealed, the

tube could be placed on the ocean floor and still be expected to last a long, long time.

As an added precaution, you can cover the weapons with grease or special rust-preventative oil and then wrap them in Valpon rust-preventative paper. (Undoubtedly, you can purchase this paper, but I do not know where. My best, most reliable source is a friend who works in an automobile parts store and saves sheets of it for me.) Wrap this paper tightly around the weapon and/or the parts packages. The grease on the weapons will tend to hold the paper.

SILICA GEL

As a last measure to control any errant moisture in the tubes, you might want to place at least two ounces of silica gel in a sixty-inch tube that's eight inches in diameter (less for smaller tubes). Silica gel is available from chemical supply warehouses for about five dollars a pound, or you can ask your druggist to save the surplus packets and caps from the bottles of pills he unpacks. Collect the surplus once a month and you will be surprised at how much you accumulate at no cost. Be sure to use silica gel as a desiccant as opposed to the other common chemical used for this purpose, calcium chloride, which is a strong salt that corrodes metal quickly under the right circumstances. Place the silica gel in a cardboard container in which you have punched numerous small holes. Throw the cardboard container into the tube right before sealing it up.

If the cache is poured solid with grease or the weapons are plastic sleeved, there is, of course, no reason to use a desiccant. Most experienced cachers report that use of silica gel is a nice gesture but not really important in terms of safe storage. If the weapons are only lightly greased, silica gel might be useful, but usually it seems to contribute little.

The most important step is to seal the tube thoroughly after it is in place and the parts are inserted. Use generous amounts of grease around the cap mouth, and be certain the air is maintained unless you elect to seal the

tube permanently. Where the cache tube is located dictates how completely it must be sealed. Tubes placed in swamps, stream beds, lakes, storm sewers, or acid baths must be completely sealed. In these cases, you probably should figure on gluing the cap in place. (In spite of the expense and difficulty, marshes, streams, and lakes are excellent cache locations because searchers have a tough time using their sophisticated electronic-detection devices. Under these circumstances, they may assume an errant reading because to do otherwise would create a huge amount of work in disagreeably cold and wet conditions.)

SOIL AUGER

Correctly burying a cache tube is something of an art; it can also be tedious and expensive. During the early '80s, I lived for a time in a very posh inner-city condominium. I felt it was important that I set up a cache, but obviously I could not do so with any safety within the building. After contemplating the situation for several months, I decided to bury it in one of the many shrubbery beds surrounding the building.

Burying a cache tube necessitates the use of a soil auger. (It can be done with a shovel, but not very well.) Soil augers, used by farmers to set fence posts, are sold in six- through twelve-inch sizes at nursery and farm supply stores for about forty dollars each. Regular caliper-type post hole digging tools are generally inadequate for the job of setting a cache tube because they will not dig down deep enough.

Soil augers are connected to the turning handle on top by a piece of three-quarter-inch pipe. The device will dig down about four feet. Augering the soil out of the hole is not difficult under most circumstances. At four feet, you must splice in an additional three-foot section of three-quarter-inch pipe using a common pipe union. Thus equipped, you can go down another two feet or more, deep enough to place a five-foot tube one foot underground.

At the condo, it was a fine, bright winter day in the desert. I put on an old pair of bib

overalls and went out to the hedge bed early one morning when I knew the manager was out of town and started digging like it was the most natural thing in the world. Nobody recognized me, and I was able to dig a twelve-inch hole down to the required depth. (At times, in gravelly soil, this is not as easy as it sounds.) A twelve-inch hole produces a huge amount of loose material, all of which I placed in burlap bags and loaded in my car. I told one curious resident that I was taking soil samples, and that was my only inquiry.

After the hole was completed, I slid the tube into the space, covered the hole with dirt, and rescattered the wood chips from under the shrubbery back over the new excavation. (Tubes placed in the ground using this method are pretty much permanent. Soil settles back in around them, making the tube virtually impossible to pull. It helps to file a bevel on the lower cap so that the tube slides easier, but even this does not provide much assistance. Tubes placed in wet, marshy conditions can be pulled with a bit more ease, but even these require quite a bit of work to retrieve intact.)

Later, during the crisp dark of evening, I crept out of the condo with my cache items. The shrubbery hid me, or I could have been in a lot of trouble. Quickly, I uncovered the tube with my hands and slid the cache items down safely below. They resided there safe and sound until 1985 when I moved back to the country. It is helpful to place a disk attached to a dowel rod or rope in the bottom of the tube so that you can retrieve small items more easily (assuming you will move items in and out of the cache). Otherwise, you may have to fish out the small parts that fell to the bottom with a magnet.

As this story demonstrates, people living in cities will have a great many more problems successfully locating a cache than those in the country. In this regard, modern-day Ameri-

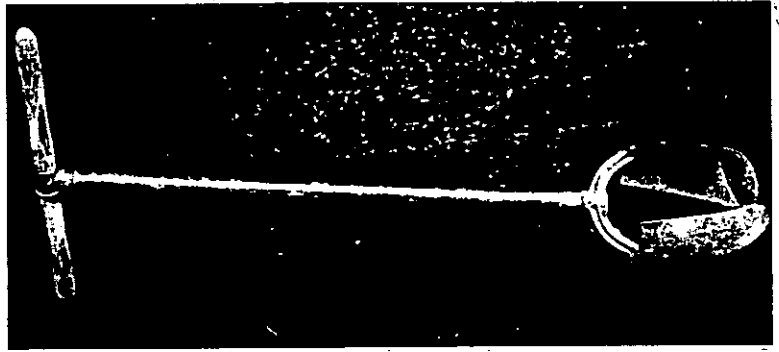

Common soil augers of the type used by farmers to set fence posts are available in sizes ranging from six to twelve inches. You should use a twelve-inch auger to place most cache tubes. A twelve-inch auger will dislodge an incredible pile of loose material from its hole, so plan ahead for disposal.

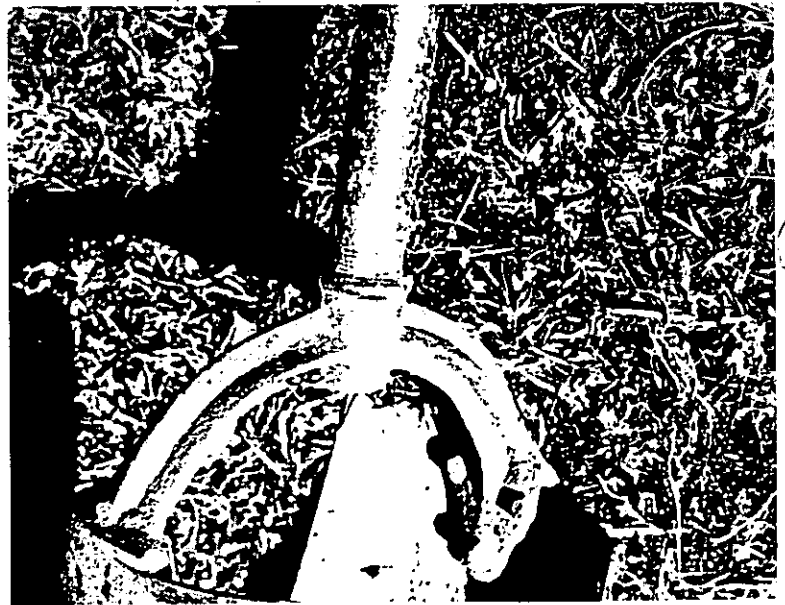

A three-quarter-inch common pipe connects the digging head of a soil auger with its turning handle.

cans are no different than members of the French Resistance or the Vietcong. If you will but look at it from the perspective of the authorities, you will realize the range of options in the country are far greater than in the city. Sophisticated searchers at my condo would have realized that the flower beds were the only place I could have cached and may have found them with sophisticated metal detectors. However, it was the only option I had in those circumstances.



Dig down into the ground five to seven feet, depending on the length of the cache tube. Placing soil on the tarp (right) helps keep the visual impact of installing the tube to a minimum.



After digging down four feet with the soil auger, splice in a three-foot section of pipe so that the hole can be bored down deep enough to hold the cache.

My favorite caching spot in the country is right in the middle of a well-traveled gravel road. Pick a spot twenty feet from a large, distinctive

tree and bore down with the auger. In spring, the digging is very easy after the initial three or four inches of gravel are turned aside. The county government did me a favor at one cache site when they blacktopped the road, permanently sealing in my cache tube. That cache will probably be there when I turn ninety. Certainly no one will find it, and my guess is that the contents will be in excellent shape.

If possible, bury chunks of steel in the vicinity of your cache—pieces of scrap, large bolts and nuts, whatever will confuse metal detectors. Place them in clustered locations away from the cache to create the illusion that the cache is somewhere near. GIs in Vietnam reported that they found metal with their mine detectors in every cemetery. They also reported that large numbers of weapons were almost always hidden in these same cemeteries. Yet, perhaps because of social problems and plain old laziness, they often did not dig in the cemeteries where they got good readings. Unless the authorities are powerfully motivated by other sources of information, such as informants, witnesses, observed traffic to the cache area, and so forth, they will probably not work their way through a large number of false readings.

If the cache tube is stored under an incinerator, outdoor barbecue, or any other place where heat may be a problem, place a piece of tinfoil or heavy reflective paper over the top of the tube. In some cases, it may be appropriate to wrap the entire tube in reflective paper (from a lumber yard) or in an old space blanket.

In summary, build a good cache tube out of SDR pipe and suitable caps, coat the weapons with rust preventative grease, wrap them in rust preventative paper, place them in the tube, and drop in a packet of silica gel if necessary. Seal the tube well and stand it vertically in a deep hole.

Be aware that clever cache locations weigh

heavily in the equation and that military-type weapons store far better than commercial ones (especially if the commercial types have extensive intricate woodwork and glass sights). Scopes, if you must remove them, should be sealed in their own separate container but placed in the tube with their intended rifles. Wood, leather, and canvas keep poorly in caches over the long haul.

Start developing a cache plan early so that the best location—whether it is a swamp, storm sewer, flower bed, road, or incinerator—can be chosen. Keep in mind that as a result of the modern materials available to cachers at plumbing supply shops, virtually any location can be utilized.



Vertically installed cache tubes are very difficult to relocate. It took great effort to dig out this one, which was in the ground for eight years.

CHAPTER 39

CACHING VS. HIDING

Most regular practitioners of the art of caching eventually find that their day-to-day activities are focused on hiding their weapons as opposed to caching. In a tough, military-type context, where the user must keep at least some of his tools reasonably handy, this is extremely common. This is precisely the trend that both the French Resistance and the Vietcong experienced. Hiding was, for these people, the art of keeping a few weapons and a relatively small number of rounds of ammunition close at hand for immediate use, whereas caching was done on a more regional basis and usually involved a larger number of weapons and explosives.

Caching is semipermanent. Hiding is a temporary measure undertaken mostly for the immediate personal convenience of the end user. Gun owners in New York and Chicago would most likely engage in hiding activities, while those in California and New Jersey would most likely cache. Of course, the intensity with which the authorities might seek out gun owners also enters the equation. Caching is generally much safer and less likely to lead to seizure.

Most gun nuts have hidden a weapon or two around their homes. Strategic caching, however, is a new concept to most people. Most people have problems differentiating between the two. There is a difference, however, and you must be able to separate the two functions in your own mind. You now have a

decision to make, but the tools are at hand if you decide to cache.

Some modern caching techniques have crossover applications for hidiers, and there are innovative new hiding methods that may be of interest to gun owners who do not feel they must cache at this time. Weapon owners must decide for themselves to what extent they are threatened and plan accordingly.

In several recent situations, it was obvious that federal marshals searching the homes of suspects deliberately attempted to tear the dwelling up as much as possible in order to coerce the property owner into giving in to their threats. In these circumstances, destruction is often not limited to what can be done with crow bar and hammer. A national news magazine recently carried a story regarding federal marshals who, in Nazi-like fashion, rented a large backhoe to assist them with the chore of tearing off a chunk of some poor citizen's home. Perhaps our marshals took their training from GIs returning from Vietnam, where entire villages were often burned in a search for weapons.

Assuming you are willing to suffer silently through a destructive search and/or maintain a low profile so that the authorities are unsure when they search, there are several modern hiding concepts that have promise. They are not foolproof, but they are helpful.

Most home hiding techniques are costly and difficult to implement. Probably the sim-

plest is to take your heating system apart and hide a weapon way up in the ducts. This will foil metal detectors, and the piece will keep nicely in the controlled atmosphere.

Be extremely cautious when implementing this or any other technique within a house or apartment. Repaint any nails and screws that are damaged, and keep any natural metal screws in nice, bright condition. Customs inspectors who search vessels for illegal drugs look first for screws that have been burred or that have paint that has been scarred.

Another excellent location is under the bathroom vanity between the riser or the sink cabinet and the floor. Again, the location is a good one because the pipes and faucets provide a sufficient mass of metal to confuse most metal detectors.

Most vanities are screwed into the wall at the rear of the cabinet. Open the doors and look at the rear one-by-twos to see if there are screw heads showing. Some cabinets will be screwed to the floor. Loosen the cabinet and fasten the weapon up under the vanity so that if it is moved, the weapon moves with it. Do not lay the weapon on the floor.

Placing a bare, unprotected weapon in this damp environment is not particularly wise. There is, however, a technique the modern hider can use to mitigate the situation. It is a vacuum-packed variation of the cache tube technology, similar to vacuum-packing meats and vegetables, and it is extremely useful for home hidiers. By blister-packing your weapons in this manner you can protect them completely from the elements as long as the packages are not handled roughly or mistreated. I am using this device to protect a CAR-15 stored in the bottom of a boat under the bilge water! After more than six months, the weapon remains in excellent condition. (The

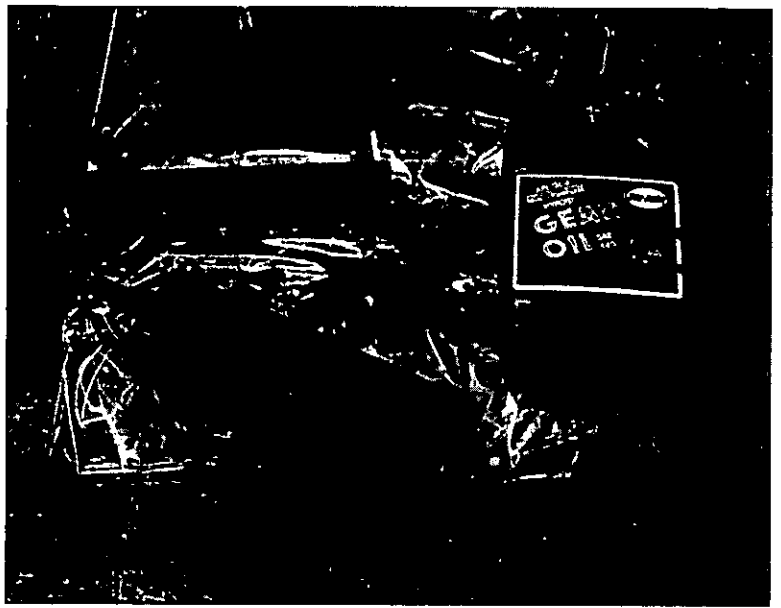

Pistol, plastic sleeve, extra magazine, and 140-weight oil ready to be assembled into a hiding package. You may be able to obtain the four-mil. plastic sleeve required for blister packing from a butcher shop.



The weapon should be oiled with 140-weight gear oil before being placed in the plastic sleeve.

example is even more remarkable because I ran the boat in salt water.)

Few special materials are needed, and those that are, when you can find them, are relative-



Oiled pistol and magazine in blister pack after the air has been evacuated from the plastic sleeve. The package is now ready to be sealed.

To evacuate the air from the package, insert the weapon into the plastic sleeve and immerse in a large container of water. Be sure to keep the open "tail" of the sleeve above water.

ly inexpensive. Start by purchasing ten feet of eight- or ten-inch wide, three- or four-mil. plastic sleeve. This material is not extremely common. Hiders must exercise a bit of flexibility and use whatever is available, provided it is in the ball park functionally.

Four-mil. plastic sleeves are much better than three-mil. ones because they are tougher. (Other plastic products usually will not work either. Zip-lock bags, for instance, will not seal to the extent necessary to make the system work. Also, at two mil., they are also a bit on the light side for weapons. Even the heaviest supermarket garbage bags are far too light and subject to tears and holes.) Be certain the sleeve is close to the size of the weapon. Excess width creates sloppy results.

In the past, I have used clear plastic army-surplus gun cases of Korean War vintage. New, longer, rifle-sized plastic sleeves are available from butcher shops and even from stationery stores at times. Auto body and parts stores sometimes get axles or drive shafts in plastic

sleeves that they will save for you. The required plastic sleeves are never easy to find, especially in the heavier four-mil. weight. Finding them is the toughest part of what is an extremely effective technique for hiding rifles and carbines. Motivated hiders simply must get on the phone and call around until they turn up a supply source.

Once you've located four-mil. plastic sleeves, final assembly into a hiding package is decidedly easy. Coat the weapon with heavy 140 weight gear oil (available at any automotive supply store), Conoco Cotton-Picker Spindle Grease (by special order), or regular lube grease. Insert the liberally greased weapon into the plastic sleeve. Weapons such as revolvers should be loaded, auto loaders stored with a loaded clip, and military carbines inserted with a loaded magazine or two. Placing ammunition with the weapon is important if it is likely that the weapon will be removed from the hide, superficially wiped off and put immediately into service.

Weapons that are properly oiled and placed in an air-evacuated sleeve are extremely impervious to the elements. They can be stored virtually any place where the plastic will not

be torn or melted.

Cut the sleeve material, which is generally sold in ten- to fifteen-foot rolls, so it is about eighteen inches longer than the weapon. (Pistols can be stored in a small pouch using the same procedure.) By leaving generous ends on the plastic sleeve, you make the completed package less subject to handling abuse that could destroy its effectiveness. This also makes the package easier to seal.

Fill a bathtub or other large container with water—a fifty-five-gallon barrel, large tank or, if one is handy, a pond or lake are ideal. Immerse the weapon and plastic sleeve on an angle so that as much water as possible covers it. (Obviously, you do not want to immerse the open end of the sleeve. Keep the extra "tail" above water.) Water pressure will force the air out of the sleeve and force the plastic to stick to the oil on the weapons. (Plastic heavier than four mil. will not shrink down and conform to the weapon as well as material of the correct weight. It is possible to use heavier plastic if one can somehow heat the water used to evacuate the air out of the package.)

Roll the sleeve end over, seal the opening with a hot iron, and tie it with a piece of nylon cord. Check to be certain the sleeve is sealed and that no air or water can leak through by submerging it in a container of water.

Sealed-up weapons can be built into false ceilings, false end walls in closets, and body panels on vehicles, where they can be kept for years. With dry wall, it is reasonably easy to place the weapon inside a wall and then replaster and paint it to look precisely as the original. Had these evacuated packets been available, French Resistance members could have placed them inside wine barrels without damage to wine or weapon.

A close friend of mine, who was forced by an unreasonable employer to work out of an office in New York City, very carefully and meticulously shortened the drawer of a file cabinet, behind which he hid a pistol. Before moving, he spent scores of hours "remodeling" his file cabinet, including calling the factory

for sheet metal parts that he had a local firm shorten. When reassembled and spray painted, the shortened drawer nicely hid his Beretta pistol with two extra magazines fastened in behind. He sent the locked file cabinet to the Big Apple via commercial movers. When he arrived in town, his personal protection was there waiting for him. As a practical matter, the scheme was extremely costly since it provided only for a pistol. Perhaps the file cabinet could have been modified to accept a CAR-15, but that would have been an even more monumental undertaking.

Professional searchers often look inside the cabinets of dishwashers and TVs, but this does not completely preclude them from being reasonably good spots in which to hide a weapon. At times, an HK-94 or a CAR-15 can be placed inside the base of the cabinet where a professional might miss them. The trick in all cases is to be very careful with nails, screws, tacks, and staples so they do not look tampered with. (DEA search manuals instruct agents to turn over couches to determine whether they feel heavy and to see if the tacks and staples holding the upholstery appear to have been tampered with.)

Any of these hides will foil the casual searcher, but they will not fool the real pro. There are three additional hides available to many apartment dwellers that will work 99 percent of the time.

Assuming you can secure the help of a professional upholsterer and/or furniture dealer, it is feasible to install sleeved weapons in a waterbed. Waterbed mattresses can be professionally opened and then closed again so that the bed is usable. I have seen this hide used on two separate occasions. The owners were unclear and evasive about how they got the weapon inside the vinyl mattress. All they would say is that the factory did it for them.

If the dwelling has a basement, consider putting a regulation cache tube in the floor. The slickest scheme I have seen involved chipping through the cement to the earth below. Chipping out old concrete is a long and arduous task. It may even involve renting a small

masonry hammer. This is a noisy, dirty tool that cannot be run in privacy if other tenants live in the building. If, by chance, the landlord or manager is alerted, you can claim you are putting in a radon trap.

Chipping out a round hole in the concrete by hand or with a masonry hammer involves cutting out wire or bar reinforcement placed in the concrete. This can be done with a bolt cutters or by using a cold chisel.

Remove enough concrete so that a complete cache tube will slide through the hole. Bring in a suitable post-hole auger and dig down five or six feet. With any luck, the underlying material will be clay rather than gravel. If it is gravel, it will collapse in on itself, making it very difficult to drill a clean hole. Water and bentonite clay purchased from a nursery supply store can sometimes be used to stabilize a difficult gravel bed through which a cache tube hole must be bored. After digging, insert the tube and fill the hole.

Close the hole by placing a dummy cast-iron floor drain over the opening. Use a standard floor drain purchased from a plumber. In some cases, it may be necessary to cement this fitting in place. You can also use regular window putty colored with soot to hold it in place. After a few weeks, the putty sets up hard enough to withstand traffic on the basement floor. If possible, place a rug over the drain cache and fill it up with dust from the floor. Be sure that when you are done the entire assembly looks old and untampered with.

Adventurers who have used this technique report that they worked a week of evenings putting the hide in place. Depending on your circumstances, it may be worth the effort, as this hide will almost certainly never be found. Metal detectors will be foiled by the cast-iron drain assembly and the wire in the concrete.

There is one other device worth mentioning that is so sophisticated that it might not be uncovered by professional searchers. Modern structures are usually built on two-by-ten-foot floor joists. To the hider, this means that a space about nine inches deep, fifteen inches

wide, and up to three or more feet long is available between the basement ceiling and the floor above it. However, hiding in between floor joists is a fairly common device that most authorities are aware of. While it has merit, it must be done very cleverly.

Move the refrigerator out from its space in the kitchen. Carefully and meticulously lift the linoleum from the spot on the floor where the refrigerator usually stands. Lifting linoleum can be quite easy or a real bitch, depending on how well the original builders put it in and how old it is. Some older apartments will likely have two or more layers of linoleum. As a rule, the floor covering under the fridge is often in fairly good condition and can be lifted without undue trauma to it or the hider.

Once the plywood or particle board underlayment is exposed, find the exact location of the floor joists below. Various builders differ in the care with which they install floor joists. Each installation is different. Use a small nail, a ruler, or an electronic stud-locating device. Draw out a 16-inch rectangle on the floor, outlining the exact midpoint of the floor joists. This marking is critical and should be done with great precision.

Using a carbide-tipped blade on a skill saw, cut the subflooring out no deeper than the 5/8-inch plywood or 1/2-inch particle board. Doing this without cutting too deeply into the supporting joists or gouging holes in the floor takes a great deal of skill. Lift out the 16-by-18-inch (or whatever size is cut) block of subflooring. Below will be a perfect hollow spot in which to hide a weapon.

Slide the plastic weapons packet into the opening. Replace the subflooring block, putting the cracks where the saw cut. When replaced, the piece of subflooring should rest nicely on the exposed part of the joists below. Roll back and carefully replace the linoleum. It may be wise to glue the linoleum back down lightly.

When the refrigerator is moved back over the hide, it creates an excellent psychological and physical barrier to searchers. The mass of the refrigerator along with the water pipes and

electrical lines in the kitchen will tend to confuse metal detectors. Searchers might be reluctant to move a refrigerator and, if they do, they might still overlook the hide if it is constructed correctly.

These three situations are not foolproof, and they probably are not long-term solutions to what may actually call for caching. They are, however, the best there is under less-than-perfect circumstances.

The Golden Rule on hiding is fearfully simple: well-trained, highly motivated officials

who are reasonably certain you have a weapon hidden in your home will find it. It is possible to make their chore very difficult, and they will tear up your house or apartment in the process, but they will find a weapon that is hidden within the confines of your home. To assume otherwise is folly.

In the end, the best solution is to maintain a low profile. If the bad guys are not sure the weapon they seek is under your control, they will be reluctant to search as hard and as thoroughly as they otherwise might.

CHAPTER 40

OUTSMARTING THE ENEMY

The current batch of sophisticated metal detectors available on the civilian market in the United States generally has a military background. However, it is tough to determine which came first, the chicken or the egg. Did commercial, hobby, and police metal detectors evolve as a matter of wartime necessity, or did the Vietnam War provide the technology necessary to develop superaccurate mine detectors? We do know that most military strategists in the United States were not planning to fight a war in which a major strategical component was caching and booby-trapping. Americans have typically attempted to substitute gadgetry for philosophy, and in their attempt to deal with strategic caching and booby-trapping, they developed some extremely sophisticated devices.

As a result, cachers must contend with highly sensitive, accurate, automated mine detectors. The only real difference between the hobby devices and the standard military units is ruggedness. Military mine detectors are made to be thrown in the back of a truck—something commercial models would not tolerate for long. For a price, commercial metal detectors that will operate at up to 250 feet under water are available.

Some metal detectors exist that will consistently locate a metal pipe 35 feet below the surface or spot a penny edgewise 18 inches underground. With these gizmos, two or more people can walk 35 feet apart and thor-

oughly sweep a wide area very quickly.

Almost every metal detector manufacturer produces a unit that can be used under extremely difficult circumstances to find ore bodies, caches, lost weapons, pipes, and wires. They are often employed by professional treasure hunters, geologists, prospectors, public utilities personnel, and, of course, police. These sophisticated new units automatically retune themselves to compensate for wet and dry ground conditions and even for changing earth composition. Modern metal detectors can be set to scan for anything metallic, but once they pick up a buried object they can be adjusted to reject the object if it is a bottle cap, nut or bolt, or pop can tab.

Hobbyist treasure hunters do not generally use metal detectors because their weight and bulk leads to operator fatigue. Good ones are also extremely expensive, but officials looking for contraband weapons the cacher has displayed in public or has bragged about to the wrong people will not be deterred by expense or fatigue.

Conventional computerized metal detectors will find a firearms cache three feet underground 100 percent of the time. They can be set to reject most small trash, unless it has been in the ground a long time. A nail, for instance, will rust in a few years, spreading iron oxide into the surrounding ground and creating a larger target. Serious seekers won't be deterred by numerous decoys; they will simply assign

some of their abundant labor force to follow behind and do the digging.

It takes about twenty to thirty hours of intense practice to become proficient with a metal detector. Because they are tiring to operate, this can mean four or five solid days. Operators must learn how to read the signals they are receiving to determine whether their find is something of value or simply ground clutter. Very old sites that people have occupied for several hundred years or more will have a huge amount of ground clutter. Some treasure hunters claim that there are more lost coins in the ground than are currently in existence. This does not include bottle caps, nails, wire, and hundreds of similar items that are lying about.

Within the large city, state, and national enforcement groups, there are operators who spend hundreds of hours practicing, giving classes, and consulting with similar officers. Civilian treasure hunters hold regional meets where birds of a feather go to compete.

Often these people are searching for nonferrous metal, which is generally much harder to find than steel or iron. Relatively speaking, the steel used in firearms can be detected more easily and at a greater depth than anything else.

To some extent, soil conditions limit the ability of metal detectors. Historic or current tidal flats contain residual salt that acts as a deterrent. Finding a cache in salt water along the coast is a bit more difficult, but a skilled operator with the correct equipment will not be slowed perceptibly.

Some regions of the United States are characterized by extensive layers of black sand, a nickel-iron elemental material that metal detectors have problems penetrating. Much of the western United States has at least intermittent deposits of black sand that, to a small extent, will protect the integrity of a cache. Treasure hunters operating in this envi-

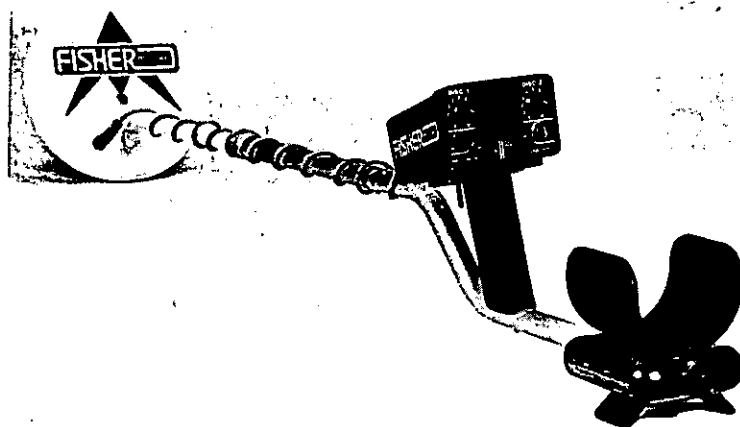

The Fisher 1265-X is a sensitive, deep-seeking, general-purpose treasure hunter's metal detector. (Photo courtesy of Fisher Research Laboratory.)

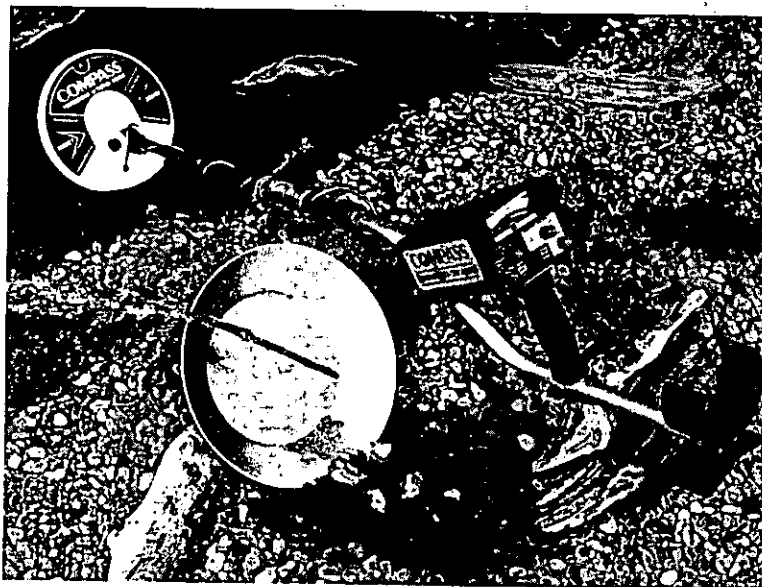

Sophisticated modern metal detectors like the Compass Scanner can be used under extremely difficult circumstances and can automatically retune themselves for varying ground conditions and earth composition. (Photo courtesy of Compass Electronics.)

ronment usually compensate for black sand interference by switching to sixteen-inch coils on their detector probes.

Cachers in heavily mineralized areas of northern Wisconsin and Michigan can also expect the authorities to have a tougher time finding their caches. Native iron in the soil plays havoc with metal detector readings. Still,

a skilled operator who runs a metal detector over cache tubes containing as few as three rifles stored receiver down will have no trouble determining something is down there. Even where there are fairly heavy concentrations of iron, he will be able to find rifles buried a foot below the surface. The metal detector may miss one rifle, but the cacher should assume that others might be found.

In central Georgia and Alabama the soil is heavy clay with a high percentage of limonite. Again, these conditions may limit an unskilled operator to some extent, but will not deter the seasoned operator. Conversely, Georgia clay tends to have a high moisture content that will materially add to the ability of the metal detector to see down into the ground. Wet to damp conditions usually produce deeper, better readings.

With the modern, computerized metal detectors that automatically compensate for changes in ground conditions, if one moves from a black sand area to clay, the machine adjusts to a great extent. Ground conditions that fooled World War II mine detectors do not even slow down modern units. Animal excrement that confused earlier detectors, for instance, has no effect. Valid readings are made quickly and easily in pastures and corrals.

Certain conditions may sometimes baffle some operators, including old barn sites, horse pastures, and places where trash was buried, oil was spilled, welding was done, and mechanical work on vehicles was undertaken. However, unless these conditions exist in large numbers lying side by side, operator confusion is usually short-lived. If a searcher is really serious, he will simply call in members of his team to probe the entire area.

All of this makes successful caching of steel weapons sound like a losing proposition. It is true that if a skilled operator runs his coil over your cache, he will probably find it. Yet, there are several additional golden rules of caching that will assist you mightily. When judiciously applied, they will swing the pendulum back in your favor.

The first is the rule of squares. This involves

the simple mathematical principle that when you double the distance from a point, there is approximately four times as much territory involved. Placing your cache not 100 feet but 200 feet out from your retreat will quadruple the territory over which the bad guys must drag their metal detectors in order to find it. At 100 feet, for example, they have 31,400 square feet to examine. At 200 feet there are 125,600 square feet involved. This is almost three acres. Take the cache out 1,000 feet or more and the search chore becomes virtually hopeless. As mentioned earlier, I believe burying in the middle of rural gravel roads is an excellent idea. Under these circumstances, your cache could range as much as five or six miles from your home.

At these longer ranges, it may pay to bury false targets, such as old bolts, nails, and trash. A search party looking as far as 1,000 feet from a retreat must thoroughly, inch by inch, cover a total of 3.14 million square feet. This is about 71 acres. Under these circumstances, 50 pounds of sixteen-penny nails scattered around would be very disconcerting.

A second rule states that the cache is less likely to be uncovered if it is located in a place that is difficult to search—where burying, mechanical work, or even stray dumping once occurred, for example. Like the Vietnamese, I would seriously consider putting a cache tube in a local cemetery if possible. Most cemeteries are open to visitors and can be accessed by car. Little rural cemeteries are much better, but some readers may not have access to these. You could almost guarantee that a cache tube in a cemetery would never be found. Ponds, streams, marshes, and lakes all fit into this category as well. A survivor in Indiana once showed me his cache tube jammed up under the bank of a creek.

A third rule involves placing the cache in a place that is virtually impossible to search. For instance, in grain bins and silos, under pig pens, and in piles of coal, gravel, firewood, or boards are all good options. These locations should be places searchers cannot check out thoroughly.

Since metal detectors do not work well in close proximity to large amounts of steel, it would be virtually impossible to locate a cache buried a foot deep in a junkyard, used car lot, or tank farm. Other than the multitude of scrap lying around just under the ground, the device would detect nothing.

Farmers and ranchers often have empty lots where they park their old, worn-out trucks, tractors, and machinery. Assuming the lot is quite large, it might be wise to put a cache tube under an old implement, knowing it will prevent the metal detector from functioning properly. This is often possible even if the lot does not belong to you.

An acquaintance in Arizona lives half a mile from an old dump that was closed in the late '50s. I suggested that he put his cache tubes in the dump ground. Metal detectors will not work at all there, and the dump site is close enough to his home that he can monitor the situation on a daily basis.

Burying in unlikely, difficult places off of your own property is almost always wise. Think seriously about placing a cache tube in the backyard of the neighborhood curmudgeon. This is the kind of person who will force the authorities to secure a warrant before they enter his property, assuming they will ever think to look there. If the location is far enough from your own property, the ruse will work every time.

It does not take much planning or bravery

to creep into the curmudgeon's yard with post hole digger, tarp, and soil bags in the dark of night. Once the tube is in place and the soil carefully replaced over the hole, the cacher can return again and again in the wee hours of the morning, or whenever, to inspect and replace the weapons. Caches can be placed in an unwitting accomplice's rose bed, behind his garage, in his garden, or even inside his barn. I once stowed a plastic-sleeved .22 rifle in a neighbor's hay manger for several months, and I am sure he never suspected a thing.

Caching in difficult, unusual places where conditions are tough for searchers makes a lot of sense. Be certain, however, that the weapons that are cached predate the 1968 gun act or have been traded around informally to the point that they are not traceable by the authorities. Should Uncle Sam send his representative to the door inquiring about the Valmet assault rifle the local dealer records show as being sold to you and the weapon is hidden in your cache, you may be stumped for an acceptable answer unless you have thought that one through.

In the final analysis, the greatest single device for outwitting metal detectors is to put as much distance as possible between you and your cache. Keep a low profile when checking it, returning as seldom as possible. In some cases, it may be appropriate to visually check from the road for problems, only uncovering the actual cache every two or three years!