

**HOW
TO KILL
TANKS**

FC 7-2



*HOW
TO KILL
TANKS*



PALADIN PRESS
BOULDER, COLORADO

How To Kill Tanks

Copyright © 1988 by Paladin Press

ISBN 0-87364-462-X

Printed in the United States of America

Published by Paladin Press, a division of
Paladin Enterprises, Inc., P.O. Box 1307,
Boulder, Colorado 80306, USA.
(303) 443-7250

Direct inquiries and/or orders to the above address.

All rights reserved. Except for use in a review, no
portion of this book may be reproduced in any form
without the express written permission of the publisher.

Neither the author nor the publisher assumes
any responsibility for the use or misuse of
information contained in this book.

INDEX

PAGE

I. SAFETY NOTE - - - - -	1
II. OBSTACLES EMPLOYMENT - - - - -	2
III. INFANTRY EMPLOYED ANTI-ARMOR OBSTACLES - - - - -	3
HASTY ROAD CRATER - - - - -	3
ABATIS - - - - -	7
LOG POST - - - - -	11
LOG HURDLE - - - - -	13
IV. FLAME FIELD EXPEDIENT - - - - -	15
MOLOTOV COCKTAIL - - - - -	16
EAGLE FIREBALL - - - - -	18
V. EXPLOSIVE CHARGES - - - - -	19
VI. MISCELLANEOUS METHOD - - - - -	23
VII. ITEMS OF EQUIPMENT - - - - -	25
VIII. REFERENCES - - - - -	26
IX. BASIC LOAD CLASS V MECH INF, USAREUR - - - - -	27
X. HOW TO KILL TANKS TRAINING AREA - - - - -	28

I. SAFETY

Reference AR 385-63, Ch 1-4, 15, 18, Policies and Procedures for Firing for Training Target Practice and Combat. This regulation incorporates the requirement and operational procedures for planning and conducting training. Limited local supplementation of this regulation has been permitted. Check with your local range, regulation, and Range Control Officer regarding authorization for obstacle employment and expedient demolition training.

"THINK SAFETY"

AND

BE

SAFE

II. OBSTACLE EMPLOYMENT

The battle leader uses obstacles to increase the effectiveness of his Anti-Armor weapons and to force the enemy to move in accordance with his plans. The Unit Commander combines the effect of the existing natural and manmade obstacles with the effects of the reinforcing obstacles emplaced or constructed by his troops to multiply his combat power relative to that of the enemy's.

Reinforcing obstacles constructed by an Infantry Company are limited by TIME, MATERIAL, PERSONNEL, and EQUIPMENT. Installation time and equipment are usually the two most important factors governing the employment of Reinforcing Obstacles. Each Infantry Company has organic to it, the pioneer tools necessary for cutting, chopping, and digging; and a demolition set. The use of explosives is the fastest means of creating obstacles. The infantryman must be able to emplace point obstacles on the battlefield in support of his Anti-Armor Weapons System. By virtue of his training and equipment, the obstacles which infantry units can construct are:

- a. Hasty Road Crater,
- b. Abatis,
- c. Log Hurdle,
- d. Log Post.

When properly sited each of these can significantly enhance the effectiveness of the organic and supporting Anti-Armor Weapons System.

Recent studies have indicated that the presence of an obstacle increases the KILL probability of the Anti-Tank Weapons as much as eight times in certain cases. In specific instances, with one Anti-tank weapon firing against one to four attacking tanks, the effectiveness of the Dragon was increased about 50%; the Main Battle Tank about 160% and the TOW by about 300%. Battle leaders at all levels must take full advantage of the opportunity to prepare the battlefield for the fight - - to reinforce the terrain, using all the capabilities of their forces and the time available.

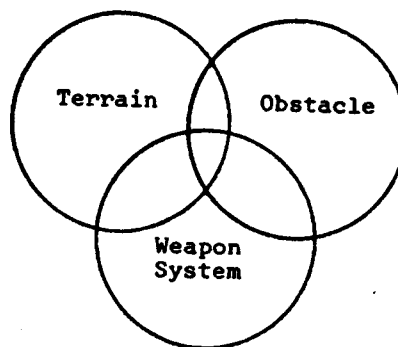

TERRAIN REINFORCEMENT

III. INFANTRY EMPLOYED ANTI-ARMOR OBSTACLES

HASTY ROAD CRATER

On a 20-foot wide road this obstacle (fig 1) takes a squad approximately one hour to prepare. The crater described above forms a V-shaped crater, about seven to eight feet deep and 20 to 25 feet wide, extending about eight feet beyond each end crater. The sides have slopes of 30°. Modern battle tanks require an average of four passes to traverse hasty road craters (3-5 minute delay). Craters formed by boreholes less than five feet deep and loaded with charges less than 50 pounds are ineffective against tanks. The following hasty cratering method has proven satisfactory:

a. Space the holes five feet apart center-to-center across the road. The formula for the computation of the number of holes is: $N = \frac{L - 16}{5} + 1$, where L = length of crater in feet measured across the roadway. Any fractional number of holes is rounded off to the next higher number.

(1) Dig all boreholes to the same depth; at least five feet, OR

(2) Employ shape charges to blow the boreholes; then clean out or fill in each hole to the desired depth.

b. Load the boreholes with 10 pounds of explosive per foot of depth, i.e. 50 pounds of any explosive in each five-foot hole).

c. Prime all charges with detonating cord and connect them to fire simultaneously. Underground charges should always be primed with detonating cord branch lines. A dual firing system should be used.

d. For hasty cratering, if standard cratering charges are used, each charge must be supplemented with 10 pounds of additional explosive to total 50 pounds of explosive per borehole.

NOTE: Cratering charges which have been damaged by moisture cannot be used.

HASTY ROAD CRATER STEP BY STEP

1. Moving to Site:

- a. Organize the squad.
- b. Break down explosives.

2. Locate the Crater:

- a. Proper placement determines effectiveness.
- b. Properly tie into the terrain, cannot be easily bypassed. You must consider how it should be laid out on your site.

3. Make Boreholes:

- a. Manual method.
- b. Explosive method.

(1) When employing the standard 15 lb or 40 lb shape charges, use the proper standoff, GTA 5-10-28, pg 8.

(2) Prime each shape charge with detonating cord and a nonelectric blasting cap. Use a line or ring main to insure simultaneous detonation.

(3) Explosive method (limited) - Breaching hard surface pavement - A one-pound charge of explosives is used for each two inches of pavement thickness. It is tamped with material twice as thick as the pavement. Concrete should not be breached at an expansion joint, because the concrete will shatter irregularly.

4. Place Cratering Charges:

- a. Always dual prime.
- b. Use detonating cord.
- c. Never bury blasting caps.

5. Backfill the Boreholes:

- a. Keep the detonating cord branch lines in the boreholes from crossing when refilling the holes. This could cause a misfire.
- b. Compact earth around the explosive. Refill the holes with earth up to the roadway. The better the tamping, the better the crater.

6. Tie in Branch Lines to the Firing System: Figure 2

- a. Lay out ring main.
- b. Employ dual firing system.

7. Detonate charges:

- a. Comply with safety distance requirements. Reference GTA 5-10-28, Pg 1.
- b. Insure friendly troops in the area have been notified.

8. Evaluate the Final Crater:

- a. Is the crater large enough?
- b. Can the crater be easily bypassed?
- c. Have covering fires and observation been coordinated?
- d. If mines are authorized, have they been installed?
- e. How effective will your crater be?

9. Forward your report.

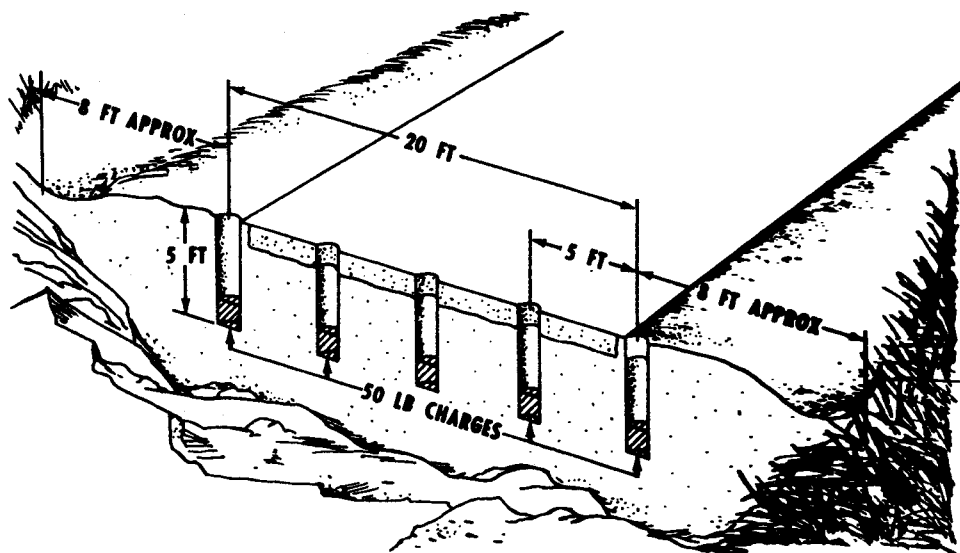
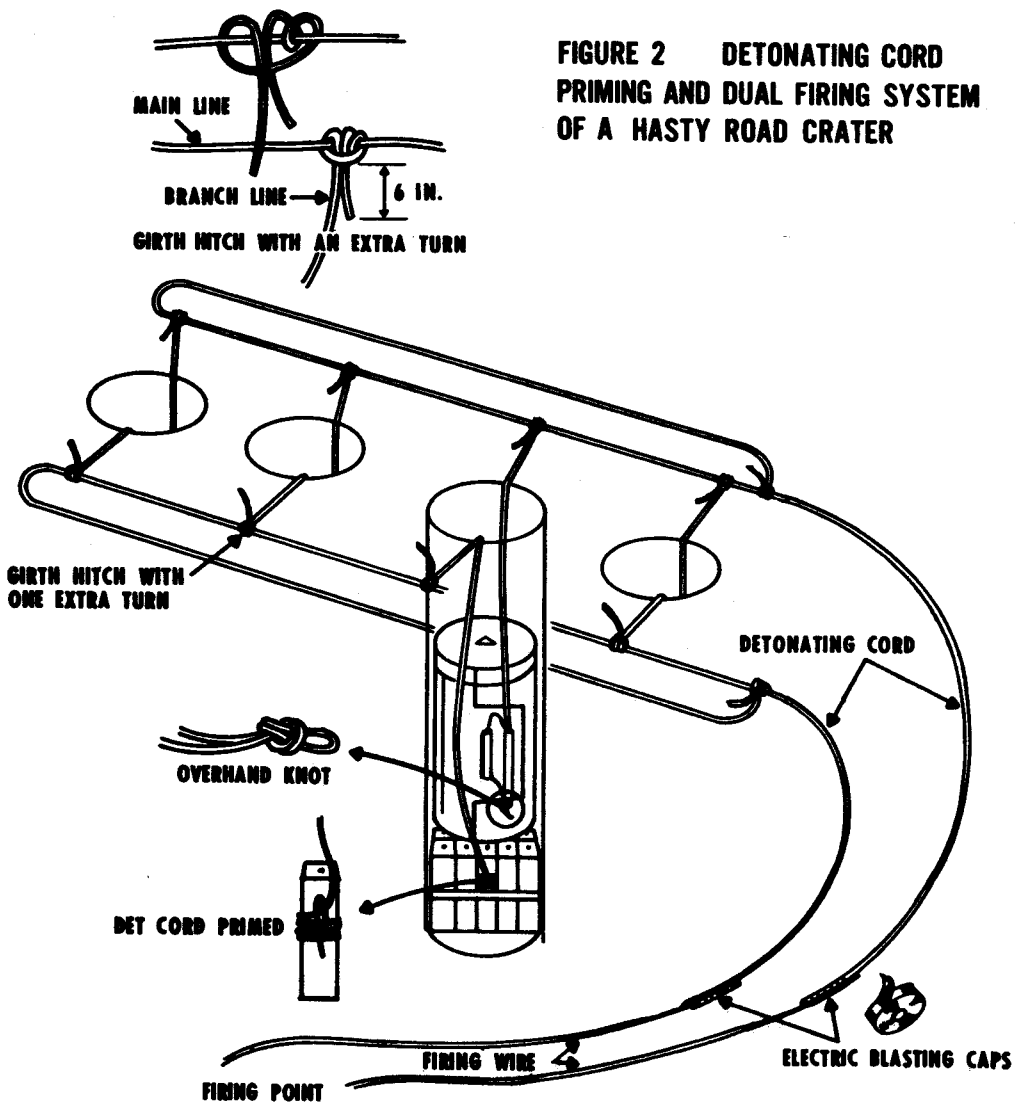

FIGURE 1 HASTY ROAD CRATER



**FIGURE 2 DETONATING CORD
 PRIMING AND DUAL FIRING SYSTEM
 OF A HASTY ROAD CRATER**

ABATIS

The trees felled as shown (figure 3) can be used to block a road or defile. This obstacle should take a squad approximately two hours to prepare. To stop tracked vehicles the trees should be at least 60cm (24 in) or more in diameter and at least 6m (20 ft) tall. To effectively block a road through a heavily wooded area, an abatis at least 75 meters (250 feet) deep is required.

a. When cutting trees and leaving them attached to the stumps to create an obstacle, use GTA 5-10-28, pg 2, to compute the amount of TNT required for the test shot. The result of the test shot will determine the need for increasing or decreasing the amount of explosives required for subsequent shots.

b. Placement of Abatis Charges. Charges for making fallen tree obstacles are placed as a concentrated external charge and should be of rectangular configuration one to two inches thick and approximately twice as wide as they are high. They are placed approximately five feet above ground level. The tree will fall toward the side where the explosive is placed, unless influenced by lean or wind (fig 4). To make the direction of fall more certain, a "Kicker charge," a one-pound block of explosive, placed about two-thirds of the distance up the tree on the opposite side may be used (fig 5).

c. Special Considerations. To be effective these obstacles should be at least 40 meters in depth and the felled trees should extend at a 45° angle toward the enemy. The trees on one side of the road should be cut simultaneously, followed by the cutting of the trees on the other side of the road. Delayed blasting of the second row of trees is necessary to provide time for the trees in the first row to fall and thereby eliminate the possibility of trees deflecting one another from their desired direction of fall. Likewise, trees should be selected with spacings great enough to allow them to fall without interference from other falling trees in the same row. Tree selection should not afford the enemy an easy breach or bypass. When trees extend laterally from the road, additional trees should be selected to add width to the obstacle and stop or deter an easy local bypass. To make the obstacles more difficult to breach, they should be mined, booby trapped, entangled with barbed wire or concertina, and covered by fire.



Figure 3
Abatis Used As Road Block

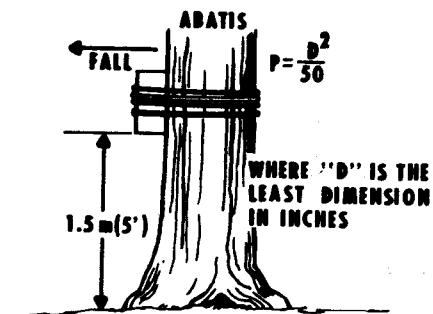

Figure 4
Charge Placement



Figure 5
External and Kicker Charge Placement

**ABATIS
STEP BY STEP**

1. Moving to Site
 - a. Break down explosive.
 - b. Organize the squad.
 - c. Insure designated personnel have GTA 5-10-28.
2. Locate the Abatis
 - a. Tree size is adequate.
 - b. Properly ties into the terrain, cannot be easily bypassed.
3. Mark/designate trees for the Abatis.
4. Conduct Test Shot; adjust the amount of explosives, as required.
5. Place explosive, IAW GTA 5-10-28, Pg 2.
 - a. Proper height.
 - b. Proper size.
 - c. Proper quantity.
 - d. Duel primed.
 - e. Trees may be felled by cutting the trees, rather than using explosives, Figure 6.
6. Place "kicker charge" as required.
7. Place ring main for each side of the road.
8. Tie in branch lines to the ring main.
9. Detonate one side of the road at a time.
 - a. Comply with safety distance requirements; reference GTA 5-10-28, pg 1.
 - b. Insure friendly troops in the area have been notified.
10. Evaluate the Abatis
 - a. Is the abatis deep enough?
 - b. Can the abatis be easily bypassed?
 - c. Have covering fires and observation been coordinated?
 - d. If mines and booby traps are authorized, have they been installed?
 - e. Is barbed wire or concertina to be used?
 - f. How effective will your abatis be?
11. Forward your report.

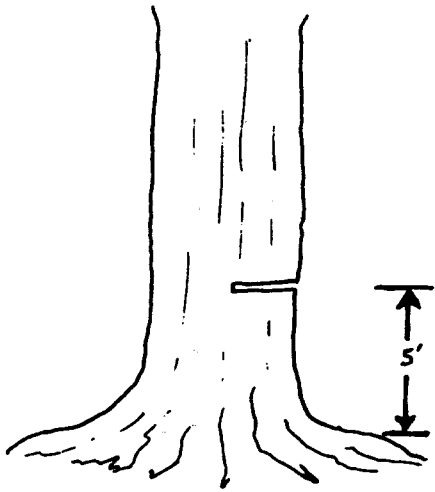

(a) Place undercut on the side of the tree in the direction of fall. (Less than half way through).

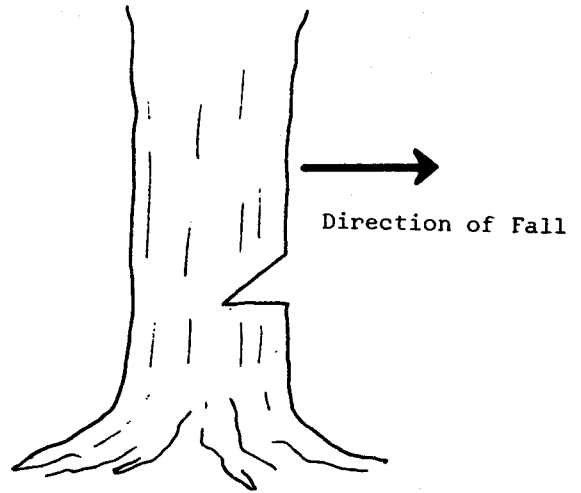

(b) Cut notch at approximately 45 degrees.

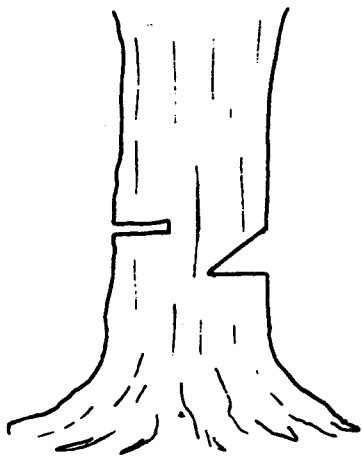

(c) Cut opposite side approximately 8" above undercut 1/3 way through.

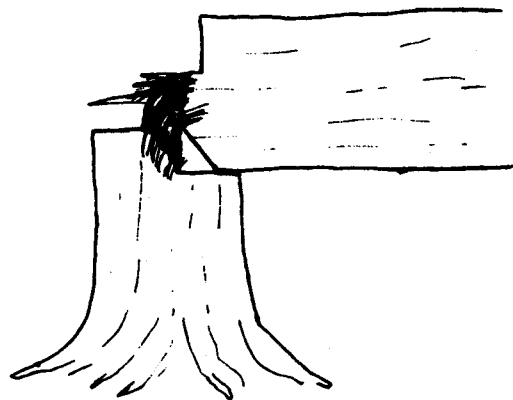

(d) Tree still attached to stump.

FIGURE 6
Tree Cutting For Abatis

POST OBSTACLES

Posts are among the most effective anti-vehicular obstacles because each post presents a breaching problem to the attacker. A squad with explosives and hand tools can block a 6m (20 ft) roadway in six hours by constructing this obstacle. There is no fast method of breaching a belt of posts. Normally, the attacker will seek to bypass such an obstacle. Post obstacles may be constructed, using either steel, log, or concrete posts.

a. **Steel Posts.** These posts usually are sections of rail, heavy pipe, or structural members. Due to their small cross sectional area, steel posts are installed over footings, dense material placed at the bottom of the hole, i.e., rock, steel plate, and concrete to prevent their being driven into the earth by the weight of a tank.

b. **Log Posts.** These posts should be hardwood, with a minimum diameter of 40 cm (15 in.). Footings are used under log posts only where the soil has exceptionally poor load-bearing characteristics. Figure 7 depicts a log post obstacle.

c. **Concrete Posts.** Precast concrete posts may be emplaced using lengths, spacing, and arrangements as described for wood or steel post obstacles.

d. **Placing.**

(1) All posts are buried 1.5 meters (5 ft) in the ground either vertically or at a slight angle toward the enemy, and project above ground level between 75 and 120 cm (30 and 48 in.). The height should vary from post to post. The minimum acceptable number is not less than four rows. The spacing should be irregular, with at least 1 meter (3.3 ft) and not more than 2 meters (6.6 ft) between posts.

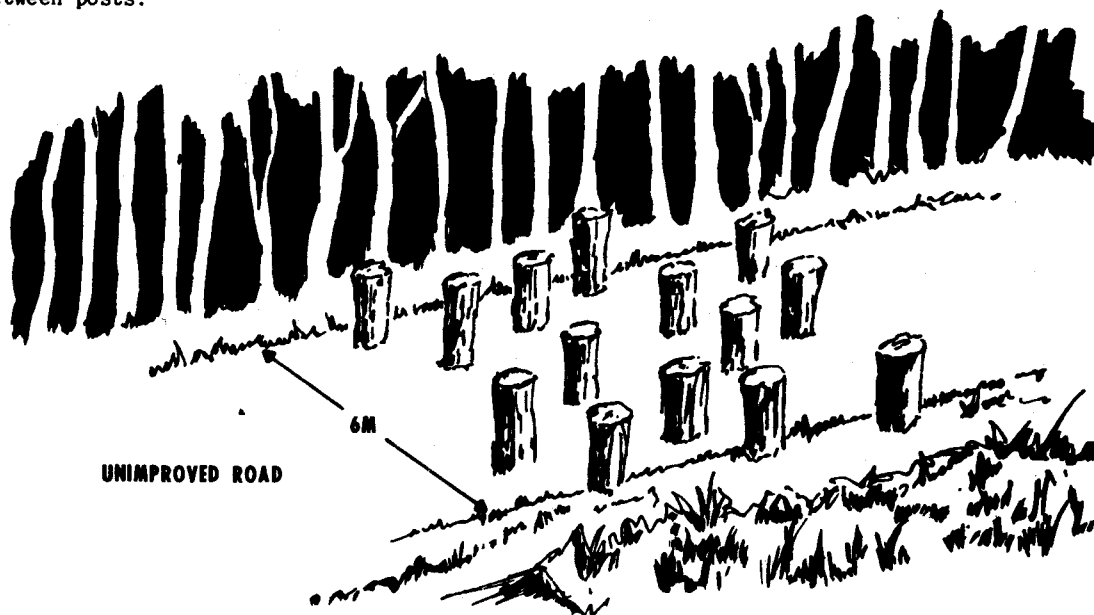

FIGURE 7 LOG POST ROAD BLOCK

(2) Posts are equally useful whether employed in long belts or in short sections as roadblocks. By predigging holes, lining them with pipe or culvert and covering them for later rapid installation of posts, the road may be kept open for use until the roadblock is needed.

POST OBSTACLES
STEP BY STEP

1. Moving to Site

Organize the squad.

2. Locating the Post Obstacle

a. Adequate post size:

Log 15 inches diameter or greater

*Steel - I Beam

8 x 4 inches or greater

WF Beam

8 x 6 inches or greater

Box Channel

9 x 2 1/2 inches or greater

Pipe

8 inch diameter or greater

Solid Concrete Beam

8 x 8 inches or greater

Railroad track

2 each

*The larger dimension should be placed parallel to enemy's route of march, giving greater stopping power and harder for the enemy to fire at.

b. Post overall lengths should vary from 7.5 to 9 feet.

3. Digging the Holes

Holes should be 1.5m or (5 ft) in depth, spaced irregularly with at least 1 meter (3.3 ft) and not more than 2 meters (6.6 ft) between holes. The minimum acceptable number of rows is not less than four. Holes are constructed by employing the 15 or 40 pound shape charge, then facing the holes, using hand tools. To break pavement when limited explosives are available, follow the procedure specified in Hasty Road Crater, Step 3.

4. Placing the Posts

a. Footings may be needed because of soil characteristics.

b. Place vertically or angle slightly in the direction of the enemy.

5. Placing Other Obstacles

Forward of the post additional obstacles may be placed to insure the enemy does not attempt to push through at high speed.

6. If mines and boobytraps are authorized, have they been installed and recorded?

7. Is barbed wire or concertina to be used?

8. Forward your report.

LOG HURDLES

Log Hurdles formed of 25 to 45-cm (10- to 18-in.) logs as shown in Figure 8 may be used to add to the obstacle effect of a crater, or other type of roadblock. A squad with explosives and hand tools can construct this obstacle in two hours. The hurdles force vehicles to reduce speed as they approach the obstacles or they may act as an additional means of trapping vehicles in the vicinity of tank ditches. Each hurdle consists of one 45 cm (18 in.) or three 25 cm (10 in.) logs firmly staked in place on a roadway or on ground suitable for use as a bypass. A hurdle of this size stops or damages most types of wheeled vehicles. Tanks can cross them at reduced speeds on reasonably level ground but are stopped by hurdles on uphill grades which approximate the critical grade of the vehicle. To stop any armor vehicle on such a slope, the size and location of the pole or log hurdle must be such that the ground line of the tank will be tilted to a slope of 1 to 1 or 100%. The logs must be firmly tied between strong stakes at not more than 1.5 meter (5 ft) internals. To determine the obstacle height a 3.5 meters (11.5 ft) long pole is held at an angle of 45° above horizontal, with one end on the ground down hill from the hurdle location. The distance between the upper end of the stick and the ground gives the required height to the hurdle (Figure 9). The hurdle should be sited on the steepest part of the slope and as near the top as possible.

HURDLE OBSTACLE STEP BY STEP

1. Moving to site
Organize the squad.
2. Locating the hurdle obstacle
 - a. Place hurdle to the front of existing obstacle.
 - b. Place hurdle on hillside.
 - (1) Measure ground slope.
 - (2) Determine hurdle size.
3. Place stakes
 - a. Place upright stakes on 5 foot centers on both sides of the hurdle.
 - b. Stakes dug in 18 to 24 inches. U-shaped pickets may also be used.
4. Placing the hurdle
 - a. Place the hurdle alongside the upright stakes.
 - b. Lash with barbed wire, WD-1, etc. to hold the hurdle in place, if the enemy attempts to rush through.
5. Forward your report.

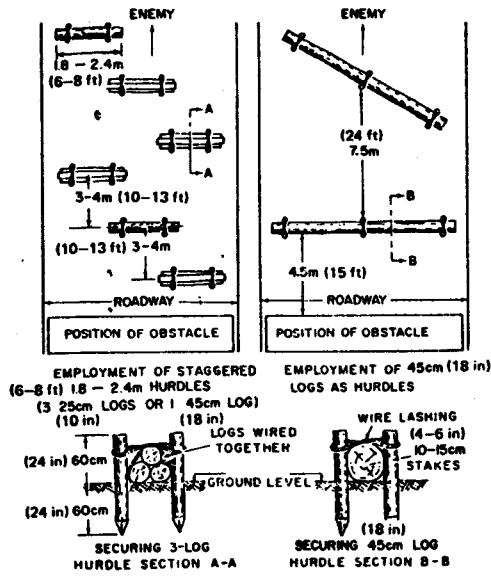

Figure 8
Type Log Hurdles

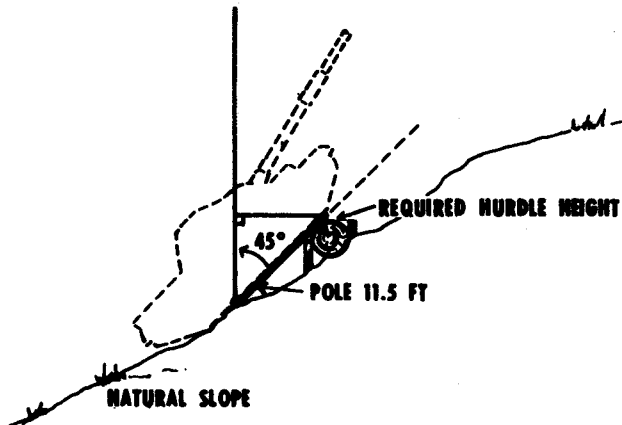

FIGURE 9
PROPER SITING OF A LOG HURDLE ON A SLOPE

IV. FLAME FIELD EXPEDIENTS

Flame Field Expedients--The company commander has available to him a large number of flame weapons which are easily constructed out of items commonly found on the battlefield. Use of these flame field expedients can significantly increase your available combat power and cause panic and confusion to an enemy. These devices include flame mines, flame fougass, flame ditches and flame illuminators. The use of flame weapons can be a major factor in the successful defense of any position. It demoralizes, produces casualties, and ignites combustible material; and it has good searching capabilities through its splattering action. When combined with infantry, tanks, and supporting fires, flame contributes greatly to the accomplishment of the mission. It is particularly effective when combined with infantry fires during the last stages of the assault.

a. Employment--Flame weapons are most effective when used suddenly and in great quantity. It is therefore imperative that the soldier employing flame weapons be properly instructed beforehand.

(1) Molotov Cocktail - Figure 11

Major Components

- (a) breakable container
- (b) combustible fluid
- (c) igniter

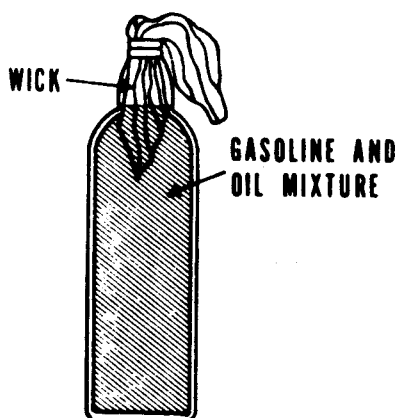

Figure 11
Molotov Cocktail

MOLOTOV COCKTAIL
STEP BY STEP

Type a. Molotov

glass bottle
gasoline (MOGAS)
rag

Type b. Molotov

glass bottle
2/3 gasoline and 1/3 (Motor oil or diesel)*
rag

Type c. Molotov

glass bottle
gasoline and 1/3 cup of soap
or
1/3 bar of GI soap
1 quart of gasoline
rag

*DO NOT USE DIESEL FUEL AS YOUR MAJOR COMBUSTIBLE LIQUID: IT WILL NOT IGNITE PROPERLY.

The Molotov Cocktail (types b and c) have a better staying power and burn longer on the target. When thrown, aim for open hatches or engine compartment.

Ignition - invert bottle to allow the wick to soak with the fluid. Insure that the wick is burning well or when thrown it may go out. After first bottle is burning on the target vehicle, additional Molotov cocktails need not be lit; just throw in the vicinity of the first.

Vollies of 4-6 will do a good job.

(2) Eagle Fireball (Figure 12):

(a) Components: Ammunition can, thickened fuel, a white phosphorous grenade wrapped with detonating cord, tape, a nonelectric blasting cap, fuze igniter, rope, and bent nails.

(b) Place or throw the eagle fireball inside an open hatch or on the back deck of the tank over the engine compartment.

b. MIXING FLAME FUEL:

(1) General--Whenever possible, thickened gasoline should be used in flame field expedients. Thickened fuel lasts longer due to its slow rate of evaporation, has greater range, and is a more effective casualty producer since it tends to stick to clothing, equipment, and skin.

(2) Thickened agent--M4 thickener is the standard US thickening agent for flame fuel. It comes in containers of the following sizes: 2 1/2 pound can, 20 pound pail, 25 pound pail, and 100 pound drum.

As a rule of thumb, the following formula may be used to determine how much M4 thickener to use:

$$\text{Amount of thickener required (ounces)} = \text{number of} \\ \text{gallons of} \\ \text{gasoline} \times 3$$

(3) Gasoline--Standard grade, quatermaster gasoline is the preferred type to use in flame field expedients. In emergencies, aviation fuel may be used, but it will not last as long, and may require more thickener to cause it to gel. In order to get a satisfactory mix of thickened gasoline, the temperature must be above 32^oF. If necessary, heat the gasoline in a container of warm water which has been removed from any direct heat or flame.

The other requirement for good flame fuel is that there be no water present in the gasoline. To check suspected gasoline for water, take a sample from the bottom of the container in a clear jar and see if any water layer is present. If water is present, it may be removed by filtering the gasoline through a large piece of canvas.

(4) Mixing --Use an ungalvanized container (55 gallon steel drum, five gallon gas can etc.) for the mixing. If large, open containers are used, wooden paddles should be used to stir in the thickener after the lumps have been broken up. The mixture should be continuously stirred until it has the consistency of applesauce. At high temperatures, a gel may not form. If this occurs, place the mixing container in running or cool water and stir vigorously.

WARNING: M4 thickener is highly moisture absorbent. Do not open the container until ready for mixing.

If using five gallon gasoline cans, place the correct amount of thickener in the can, close the lid, and slosh it vigorously until the gel forms. Insure that the gel is thickened throughout the fuel mixture before you stop stirring. If time allows, let the gel age overnight before placing it in the flame field expedient. This will permit the lumps to smooth out, and a much more uniform mixture results.

c. Effects--There are several vulnerable points on a tank when employing flame weapons.

(1) Hatches - place, drop or throw inside an open hatch. This will cause secondary fires and activate the internal fire extinguishing system. Once the extinguishing system is activated the crew must exit the vehicle immediately even if they have their protective masks on. REASON - the fire extinguishing material is TOXIC.

(2) Engine compartment - place, drop or throw on the back deck of the tank over the engine compartment. This will cause secondary fires and activate the internal fire extinguishing system. The engine and crew compartments are consolidated into one system causing the crew to exit the tank.

(3) Exterior fuel cells - once punctured by small arms fire this 20-30 gallons of fuel may be ignited by flame weapons but no significant structural damage will occur or the extinguishing system be activated.

EAGLE FIREBALL
STEP BY STEP

1. Container Ammo can. Open a small channel in the lip of the can with a pair of pliers.
2. Fill with thickened fuel - see mixing flame fuel.
3. Prepare white phosphorous grenade.
 - a. when preparing the white phosphorous grenade, take the following action:
 - Tape the lever to the body of the grenade with two to three wraps of tape. Place six wraps of detonation cord around the WP grenade.*
 - b. Prior to placing the grenade into the thickened fuel, remove the safety pin. This allows the fuse to detonate, and insures secondary ignition of the thickened fuel when detonated.
4. Tape a nonelectric blasting cap with a short 6 inch piece of time fuse and fuse igniter to the detonating cord.
5. Insert the grenade into the Napalm; let the time fuse out through the channel in the lip of the can. Remember to pull the grenade pin prior to sealing the container.
6. If available short pieces of rope and bent nails can be used to construct a grapnel, which will insure that the eagle fireball remains on the tank until detonation. The hooks of the grapnel will catch on protruding assemblies on the tank.
7. Pull fuze igniter just prior to placing the eagle fireball on the tank. Remember standard time blasting fuze burns at 40-42 seconds per foot.

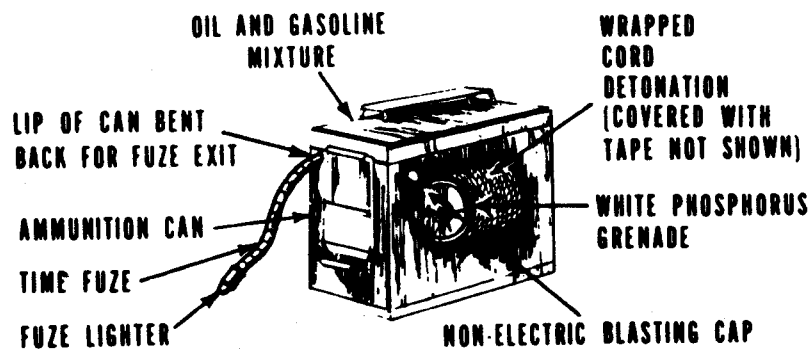

Figure 12
Eagle Fireball

V. EXPLOSIVE CHARGES

1. Hand-carried charges:

a. Type: Pole charge (Fig 13). Hand-carried charges are constructed, using TNT or Composition C-4, primed with nonelectric blasting caps, time fuze, and fuze igniter. Time fuzes should be approximately six inches long. When using pole charges, a length of detonating cord must be used to extend from the charge itself down to the handle of the pole. The charge must consist of at least ten lbs. of TNT or C-4.

b. Type: Demolition Charge Assembly.

(1) The M183 demolition charge assembly, or "satchel charge," is used primarily in breaching obstacles or demolition of large structures where large demolition charges are used. It is also effective against enemy armor.

(2) Components: The M183 demolition charge assembly consists of sixteen M112 (Comp. C-4) demolition blocks and four priming assemblies, for a total explosive weight of 20 pounds. The demolition blocks are packed in two bags, eight blocks per bag, and placed in a canvas carrying case. Each priming assembly consists of a five-foot length of detonating cord with an RDX booster crimped to each end, and a pair of M1 detonating cord clips for attaching the priming assembly to a detonating cord main line.

c. Employment: The pole or satchel charge is thrown or placed on the rear deck of the tank just over the engine compartment, causing a mobility kill.

2. Command detonated charges.

a. Components: Shaped charges, demolition charges, artillery shells, mines and bombs, electric blasting caps, communication wire, power source (blasting machine), and Composition C-4.

b. Construction: Command detonated charges are constructed, using a primer with electric blasting caps. To employ the standard shape charges as a tank killing munition, figure 14 depicts extended standoff distances that the conventional shape charges may be placed from the target and still obtain penetration and spalling. Multiple charges may be placed in series and spaced along a route to inflict extensive damage upon an armored column. When using artillery shells or bombs, they should be primed with an M-10 universal destructor (Fig 15). Bombs and shells should be buried not more than one to two inches under the surface of the roadway which the tank is expected to travel, and detonated by a concealed and protected observer. A 4.2 inch mortar round detonated under the tank's track will cause a mobility kill. Mines may also be command detonated by inserting an electric blasting cap into the secondary fuze well of the M-15 or M-19 AT Blast Mine. The M-21 AT Mine does not have a secondary fuze well. To insure positive detonation a dual firing system should be used.

c. Employment: Charges are placed in likely approach routes and, at the proper time, electrically detonated.

d. Effect: Depending on the type and size of the charge, it will stop or destroy the tank.

3. Towed charges.

a. Type: Daisy chain (Fig 16).

(1) Construction: A Daisy Chain is constructed by connecting a series of armed antitank mines with rope or wire. One end of the rope is anchored on one side of the road, so that when the rope is pulled across the road the mines are spaced across the roadway. Several ropes may be prepared and spaced along a trail or road to add depth to the obstacle. The Daisy Chain may also be used to close a lane between obstacles or a defile. To prevent the tank's tracks from passing between any two pressure type mines, place them along the rope every 2 feet. This system may also be employed by observers on both sides of the road. A Daisy Chain, with six AT Blast Mines, a sufficient number to cover the total width of the tank, is pulled in front of the tank, just as it approaches. If the M-21 Tilt Rod Mine is employed in a Daisy Chain, added stability is required due to the mine being top heavy. Place and tie each mine on a board approximately 2 ft square. To prevent tanks from passing between any two M-21 mine when employing the tilt rod, one mine every 3 meters (10 ft) is required. A dual observer system may also be used with a single stabilized M-21 Tilt Rod Mine. This method is easier for the observers to handle and less demanding on the logistic system. When employing this method from a concealed and protected position, the observers should again take advantage of the tank's frontal visual dead space.

<u>NAME</u>	<u>TYPE MINE</u>	<u>TYPE KILL</u>
(2) Effect: M-15 Antitank Mine	Blast	Mobility
M-19 Antitank Mine	Blast	Mobility
M-21 Antitank Mine	Shape Charge	Catastrophic

b. Type: Sled Charge (Figure 17).

(1) Construction: A sled charge is constructed by fastening 20-25 pounds of TNT or C-4 in a container. The explosives should be configured to maximize contact with the track. Two layers of 12 blocks of TNT or C-4 will be most effective. Almost any type firing device may be used to detonate the charge; or if desired, an electric blasting cap with a power source. The preferred method is the M-1A1 pressure firing device which will self activate as the track make contact with the sled. The sled charge is employed by an observer(s) who pulls the charge across the road and under the tank track at which time the charge is detonated. Proper timing of this maneuver is critical.

(2) Effect: When detonated under a tank track, a mobility kill will result. If the charge is detonated under the belly of the tank, no known structural damage will result, but the crew will be stunned momentarily.

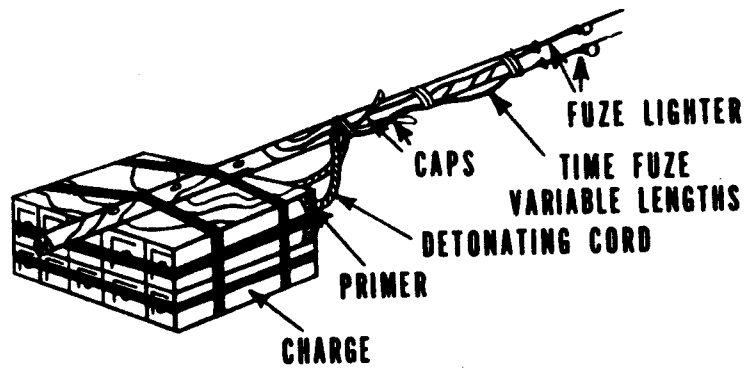

Figure 13
Pole Charge

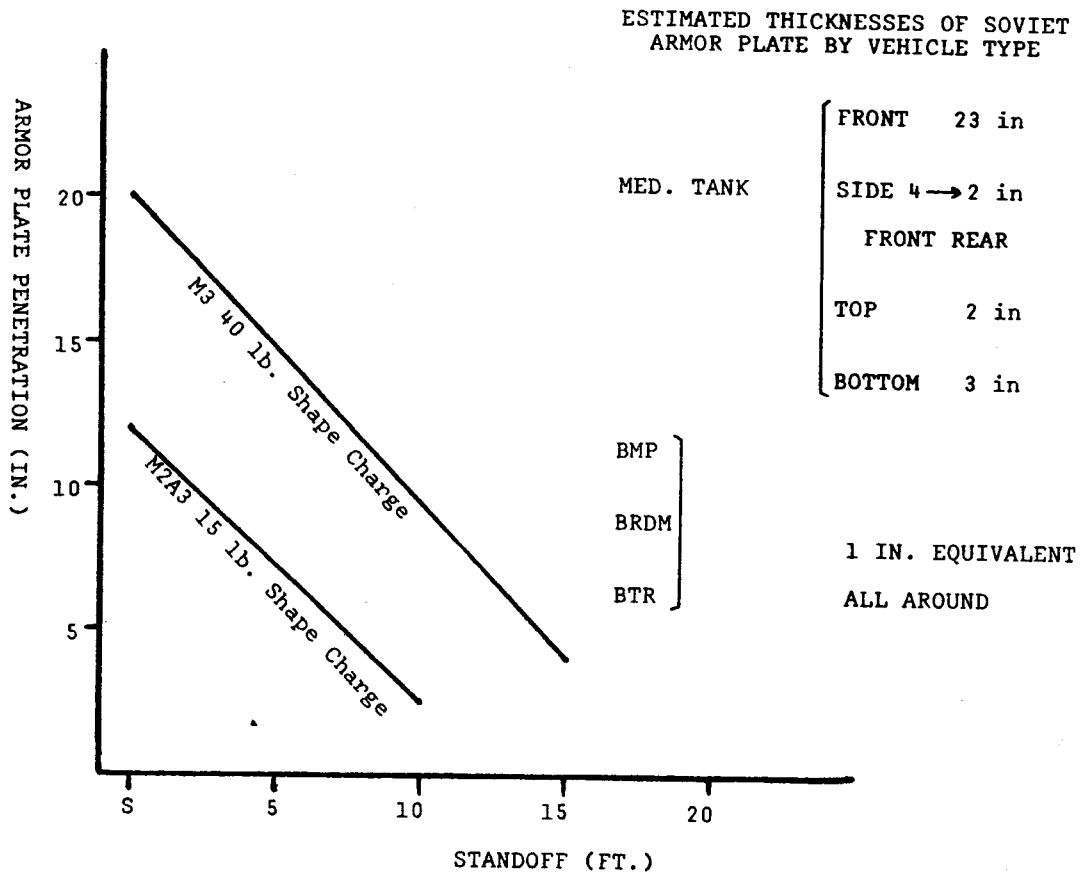

FIGURE 14 CONVENTIONAL SHAPE CHARGE EMPLOYMENT AGAINST ARMORED VEHICLES

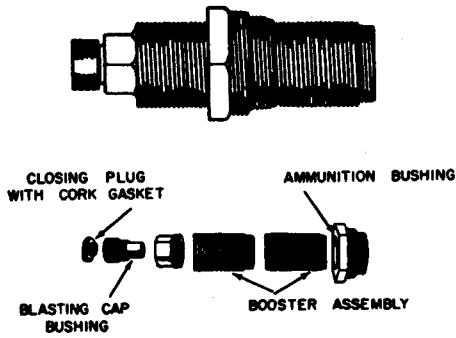

Figure 15
M10 Universal Explosive Destructor

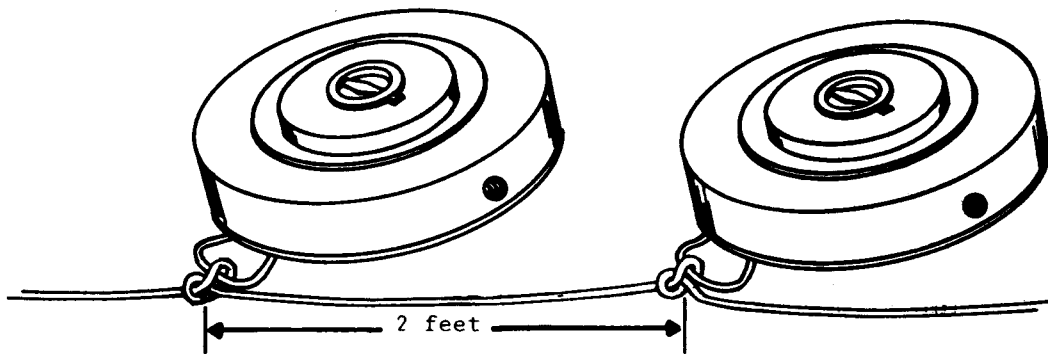
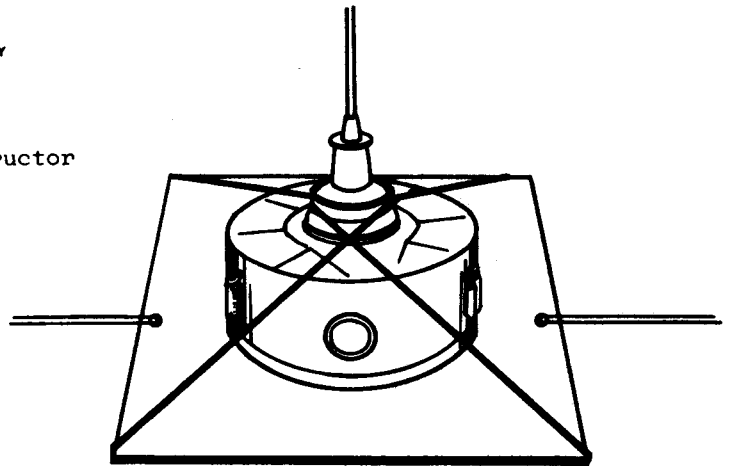

FIGURE 16: DAISY CHAINS

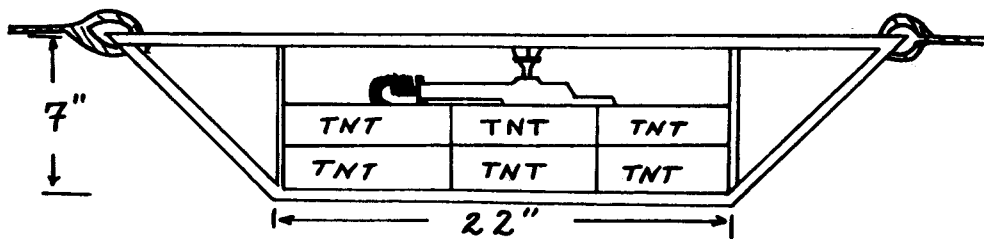

FIGURE 17: SLED CHARGE WITH PRESSURE DEVICE

VI. MISCELLANEOUS METHODS

METHOD 1: A claymore or M-16 AP Mine with a trip wire suspended 15 feet up in a tree will allow the supporting infantry to pass unhurt. The antenna on the tank will catch the wire and the mine will finish off the tank commander and the loader.

METHOD 2: Two sections of bangalore torpedo taped together and fuzed nonelectrically will destroy a tank's suspension when placed lengthwise along the road wheels.

METHOD 3: The use of civilian vehicles to hinder the advance of enemy vehicular columns along major road networks should not be neglected. They can be used to create temporary obstacles at critical locations simply by stopping them lengthwise across a narrow road and setting fire to them, or large numbers of automobiles manned by fleeing refugees can be taken advantage of to create massive road traffic jams, forcing the enemy to move cross-country.

METHOD 4: The flooding of large areas of low countryside can serve to restrict enemy movement.

METHOD 5: A five-gallon can of MORGAN with a claymore placed behind it, when detonated will clear the area of all dismounted troops and button up the tanks.

METHOD 6: Two strands of 5/8 inch wire rope laced through the forested area at a height of 3.5 feet will catch between the hull and the turret. The wire rope should be fixed to trees eight inches in diameter or greater.

METHOD 7: Remote detonation of charge, using standard US firing devices. All charges which can be command detonated can be prepared so that the enemy will detonate the charge as he passes.

EXAMPLE: A 15 or 40-pound shape charge placed horizontally alongside the road so that the charge will hit the vehicle when detonated. The shape charge is primed nonelectrically, using detcord, and is attached to an M-3, pull release firing device. The trip wire is placed across the road so that vehicles when traveling the road activate the firing device and detonate the shape charge which kills the vehicle. The employment of the firing devices can be used with, but not limited to:

- a. Standard Military Explosive.
- b. Flame Field Expedients.
- c. Mines AT & AP.
- d. Shape Charges.
- e. M72A1 Law.

METHOD 8: Stacking of antitank mines - AT blast mines (M-15 & M-19) may be stacked in order to increase the destruction on the target. There is no added effect when M-21 shape charge mines are stacked. When stacking blast type mines, the base mine should be placed in the ground 12-14 inches, with the second mine inverted so that the pressure plates of the two mines are in contact with each other. Once armed and stacked, they should be covered with one to two inches of earth. The effects of such will significantly increase the probability of causing a catastrophic kill on a tank, or when detonated under a tank roller, will render it unservicable.

METHOD 9: Steel Obstacles - Hedgehog or tetrahedron, (Figure 18) are relatively light weight for the obstacle effect they provide, and they are quickly installed or removed. They are designed to revolve under wheeled vehicles and puncture them or to belly up tracked vehicles. Unless kept under observation and covered by fire, the enemy can readily move them aside. They are well adapted for use in vegetation or urban environment. Exposed parts may be painted to blend with the background. Unit maintenance elements with a welding capability may construct such obstacles using sections of rail, heavy pipe or structural members. The legs should be cut in lengths of 5 feet so that their finished height is approximately 4 feet. Structural steel, 4 inch x 4 inch x 0.5 inch angle or larger, should be used. To determine the number of hedgehogs or tetrahedrons required, measure the gap in meters and then multiply by 1.5. Example: 10 meter gap (roadway) x 1.5 = 15 steel obstacles to be effective.

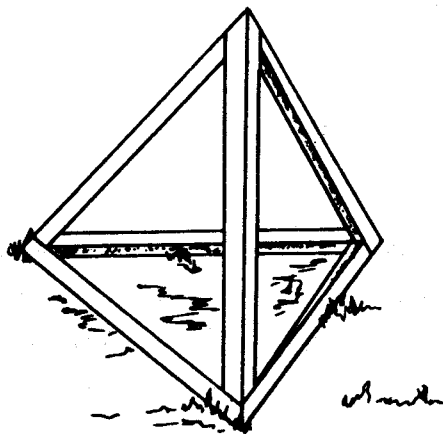

STEEL TETRAHEDRON

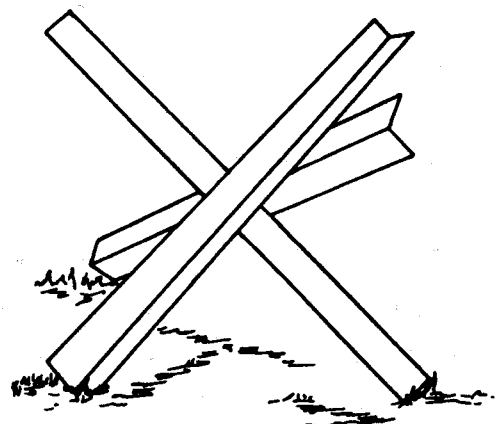

STEEL HEDGEHOG

FIGURE 18

METHOD 10: Two smoke grenades tied to each end of a string or wire two feet long can be thrown or dropped so to rap around the main gun tube near the turret. This will temporarily blind the gunner while the grenades burn.

METHOD 11: Small arms fire - Small arms fires can be effective against the tank in several areas.

- (1) Cause the crew to button up
- (2) Puncture exterior fuel cells.
- (3) Render vision blocks unservicable
 - (a) Multiple hits 5.56 mm
 - (b) Single hit 7.62 mm or larger
- (4) Penetration of the tank's hatches by 50 cal. AP can be achieved when engaging the tank from above.

METHOD 12: Limited only by the imagination and ingenuity of the soldiers who design and/or emplace them. IF IT WORKS . . . USE IT!

VII. ITEMS OF EQUIPMENT

The following is a list of major items that would be needed to conduct the "How-to-Kill Tanks" training

<u>DODAC</u>	<u>NOUN</u>
	MOGAS
	MOTOR OIL
1330-G900	Grenade Hand, Inc.
1330-G930	Grenade Hand, HC
1330-G937	Grenade Hand, WP
1345-K092	Mine Antipersonnel M-16
1345-K143	M-18A1 Claymore
1345-K180	Mine Antitank, M15
1345-K181	Mine Antitank, M21
1345-K250	Mine Antitank, M19
1365-K917	Fuel Thickener, M4
1375-M023	Charge, demolition block, (C-4) 1-1/4 lb block M112
1375-M028	Charge, Demolition Kit, Bangalore Tropedo
1375-M032	Charge, Demolition: block, 1-lb, (TNT)
1375-M039	Charge demolition blk 40-lb. (cratering)
1375-M130	Cap, blasting, Electric
1375-M131	Cap, blasting, Nonelectric
1375-M241	Destructor, Universal M10
1375-M420	Charge, Shape 15#, M2A3
1375-M421	Charge, Shape 40#, M3
1375-M456	Cord, Detonating
1375-M630	Firing Devices, M1
1375-M626	Firing Devices, M1A1
1375-M627	Firing Devices, M5
1375-M636	Firing Devices, M3
1375-M670	Fuze, Blasting, Time:
1375-M766	Igniter, Time Blasting Fuze
4010-00-274-6817	Wire rope 5/8 in. dia. 600 ft.
4010-00-273-8332	Wire rope 3/4 in. dia. 600 ft.

VIII. REFERENCES

FM

FM 5-15

Field Fortification

FM 5-25

Demolition and Explosives

FM 20-32

Mine/Countermine operations at company level

FM 20-33

Combat Flame Operations

FM 90-7

Obstacles

TM

TM 9-1345-203-12 & P

Land Mines

TRADOC Bulletin #10

The Soviet Main Battle Tank Capabilities
and Limitations

TC

TC 7-24

Antiarmor Tactics and Techniques for
Mechanized Infantry

TC 25-2

Training Ranges

GTA

5-10-28

Demolition Card

5-10-27

Mine Card

ARTICLE

Soils & Slopes

Armor Magazine dtd Sep-Oct 79 by
CPT Daniel O. Graham, Jr.

IX. BASIC LOAD

CLASS V

The following bulk demolition items are issued to infantry units in the European theater as indicated, IAW USAREUR Reg 710-65, dtd 7 October 1976.

<u>DODAC</u>	<u>NOUN</u>	<u>QUANTITY</u>
1345-K010	Burster, Incendiary M-4, Per Bn	Mech 60 ea Inf 40 ea
1345-K092	Mine AP M-16	8 ea
1345-K121	Mine AP, M-14	6 ea
1345-K143	Mine AP, M-18A1	30 ea
1345-K146	Mine AP, M-26	6 ea
1345-K181	Mine, AT M-21 Per Bn	344 ea **
1365-K866	Smokepot, Hc 30 lb	6 ea
1375-M023	Charge, demolition block, C-4, 1-1/4 lb block M112	
	OR	
1375-M032	Charge, demolition blk 1 lb TNT, Per Bn	3,300 lbs
1375-M028	Demolition kit, bangalore torpedo, M1A2	1 ea
1375-M420	Charge, Shape 15#, M2A3	*
1375-M130	Cap, blasting electric	All 150 ea
1375-M131	Cap, blasting nonelectric	All 300 ea
1375-M421	Charge, Shape 40#, M3	2 ea
1375-M448	Detonator, Percussion, 8-second delay, Per Bn	13 ea
1375-M450	Detonator, Percussion, 15-second delay Per, Bn	6 ea
1375-M456	Cord, detonating, 1,000 ft., Per Bn	13 ea
1375-M626	Firing device, demolition M-1A1, pressure type Per Bn	150 ea
1375-M627	Firing device, demolition M-5, Pressure-release Per Bn	200 ea
1375-M631	Firing device, demolition M-1, Release-type, Per Bn	250 ea
1375-M670	Fuse, Blasting time M700, 50 ft Coil	10 ea
1375-M766	Igniter, Time blasting fuse, M2 or M60	150 ea

* NOT REQUIRED IN BASIC LOAD - UNIT COMMANDER'S DISCRETION.

** SUBSTITUTION OF M-15 AT MINE FOR M-21AT HAS BEEN ENCOUNTERED WITHIN USAREUR.

HOW TO KILL TANKS

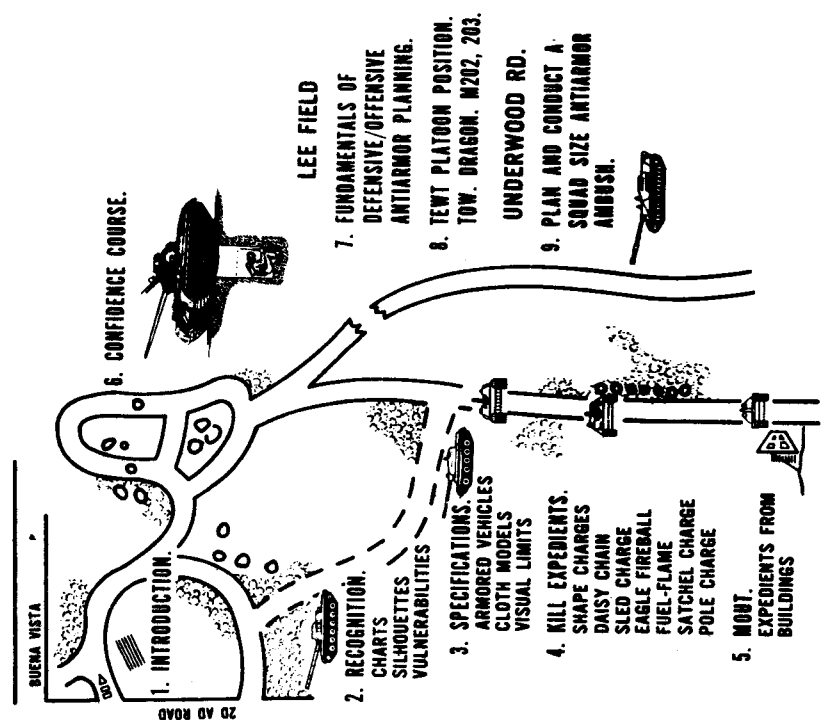
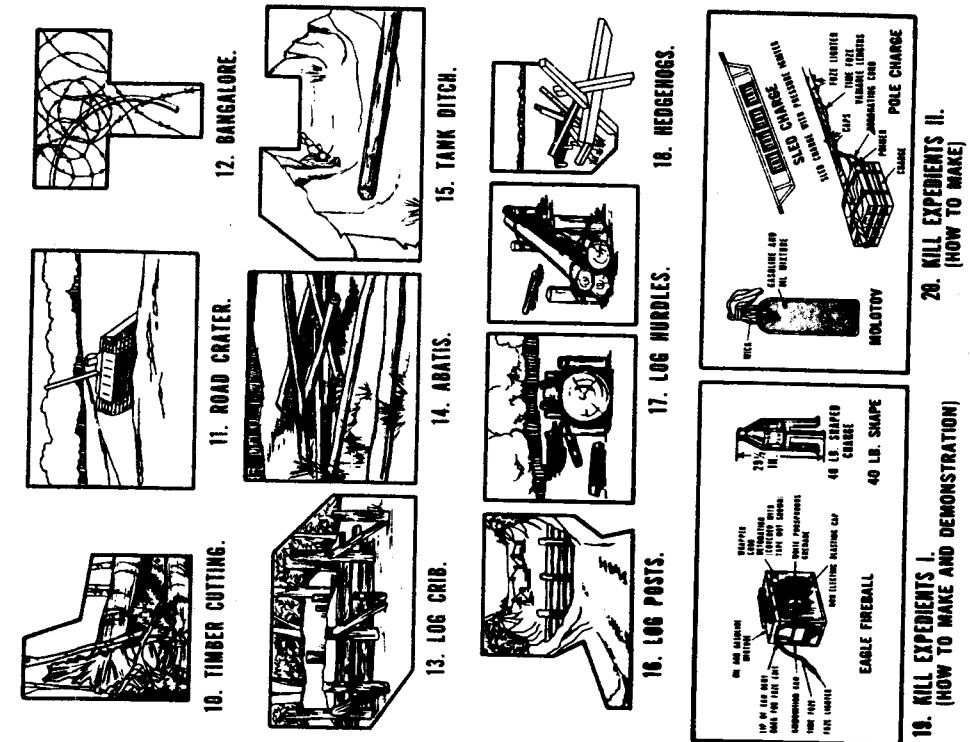

TRAINING AREAS

10. **TIMBER CUTTING.**

11. **ROAD CRATER.**

12. **BANGALORE.**

13. **LOG CRIB.**

14. **ABATIS.**

15. **TANK DITCH.**

16. **LOG POSTS.**

17. **LOG HURDLES.**

18. **HEDGEHOGS.**

19. **KILL EXPEDIENTS I. (HOW TO MAKE AND DEMONSTRATION)**
 SHAPES (10 IN. DIA. BODY, 1 1/2 IN. DIA. HEAD, 2 IN. DIA. TAIL) WITH SHAPES FOR HEAD, BODY, AND TAIL. (1/2 IN. DIA. TAIL).
 EAGLE FIREBALL (WITH TELLING INJECTION CAP)
 40 LB. SHARPED CHARGE
 40 LB. SHARPE

20. **KILL EXPEDIENTS II. (HOW TO MAKE)**
 MOLOTOV
 CLEANING APP. OR BOTTLE
 POLE CHARGE
 SLED CHARGE
 100 LBS. WITH TIGHT ROPE
 FIRE LIGHTER
 LINE FEET
 MASKING TAPE
 PROPAGATING LEAD
 POINT CHARGE

