

IMMORTAL BRITAIN ~ A.V. INSOLE

IMMORTAL BRITAIN

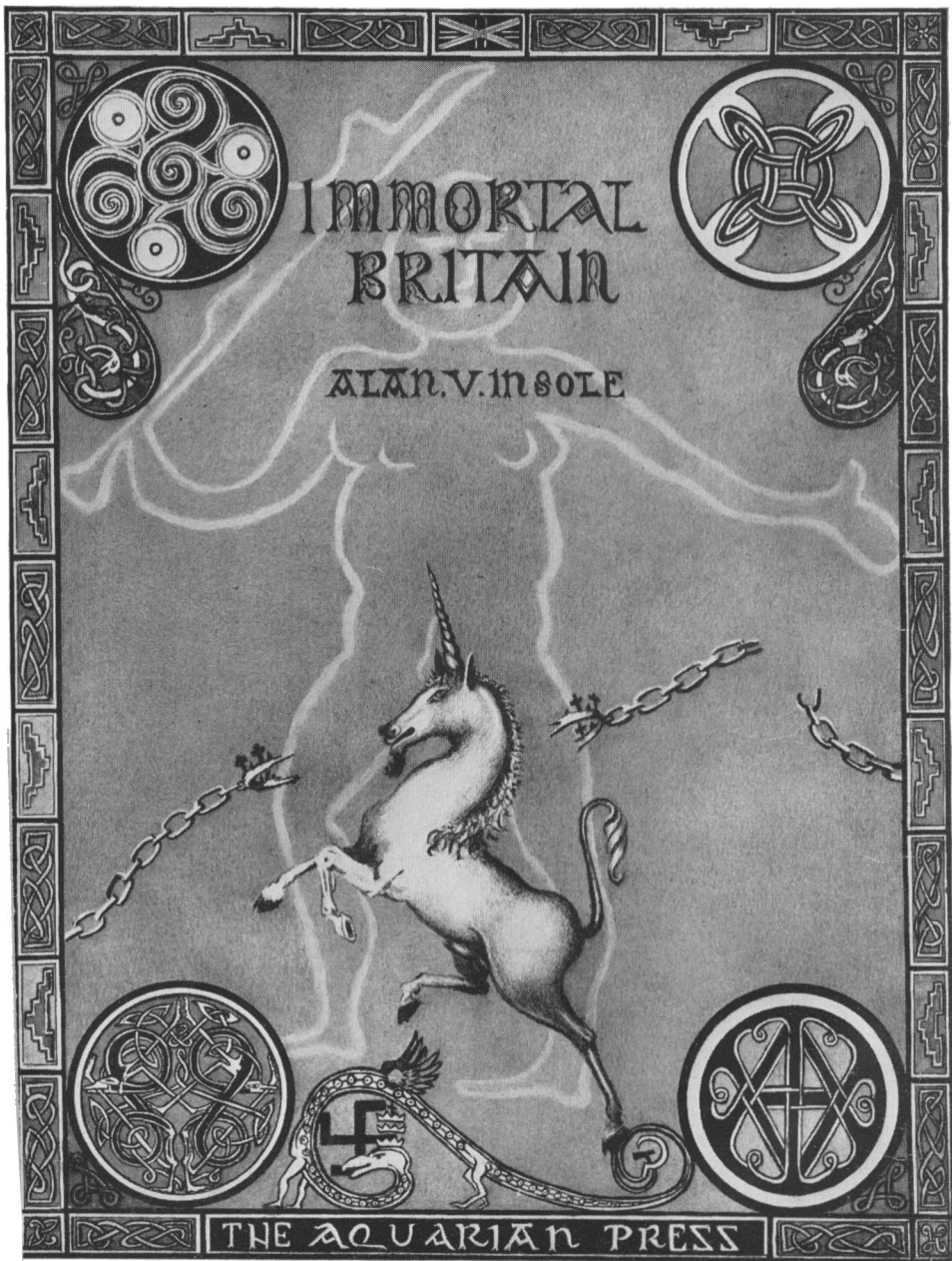

Think not these symbols of the ancient past
Are without meaning in the Atomic Age:
They are the coded language of the Gods.

★ ★ ★ ★ ★ ★

The stellar and heraldic symbols all presage
From Ancient Britain springs the Messianic Age.

Immortal Britain

by

ALAN V. INSOLE

First Edition

★

THE AQUARIAN PRESS
LONDON

1952

Published by
The Aquarian Publishing Company (London) Ltd.
30, Denison House
296, Vauxhall Bridge Road
London, S.W.1

Printed by the Courier Printing and Publishing Co., Ltd.
Tunbridge Wells, Kent

DEDICATED

To the memory of my friends
Clive Forrest, Jack Gladstone, George Howkins, Geoffrey
Wainwright, and my brother Claud.

Gentle, gallant Claud is dead ——— It was a beautiful day, and, after looking round for an hour or so, I returned to my dugout, and Keith Menzies rang me up and told me Claud had been killed by a shell. "I thought you would like to know," he said, and I replied "Thanks"! Speech means nothing. The divisional chaplain said to our chaplain, Mog, when the battle was on: "What have you been doing, Mog?" "I called at the casualty-clearing station and buried eight men," replied Mog. "Good," said the other man of God.

HISTORY OF THE WELSH GUARDS.

*“ I believe that in the end
Truth will conquer. ”*

JOHN WYCLIFFE (1384)

CHAPTER I.

PROPAGANDA DISGUISED AS HISTORY.

*When a land neglects her legends
Sees but falsehood in the past
And its people view their sires
In the light of fools or liars,
'Tis a sign of its decline.
Branches that but blight their roots
Yield no sap for lasting fruits.*

R.G.C.

ONLY in the last few years have we coined the expression "Cold War." We are becoming aware that the perils of mental conflict are as dangerous to our whole way of life as those of physical combat; we realise that "Cold War" is not only an attempt to minimise the benefits of victory in the field of battle, but also to prepare the way for active war in the future. But we have no conception how it came about that the "Cold War" so quickly turned the great victories of 1918 into dust and ashes. Yet we have need to know, for the slow evolution of social organization is moving from scattered tribes, through little kingdoms and great empires to world government. For future generations there is no alternative between a single Commonwealth Government and a giant Slave State.

One of our leading educationalists, Sir Richard Livingstone, wrote during the last war that:—

The forces that move the world need to be informed and disciplined by the intellect, but they are not in themselves intellectual The Moving Force is a Vision The weakness of England and America is that they have no clear vision. Indistinct and blurred figures stir them in their uneasy sleep, but they have not taken form. That has been a grave weakness in the war; it will be a much graver one when we face the problem of peace.⁽¹⁾

In the realm of psychology we have recently become aware that many an adult suffers from severe physical and mental disability through some long forgotten conflict as a child; but that a cure can be effected if the memory is brought to the surface of the conscious mind by deep-analysis. The blurred figures in the uneasy sleep of Britain and America are the result of a shattering blow that was dealt to the democratic way of life in the opening of the "Cold War" more than two thousand years ago. We have no clear vision to-day because we are, in a sense, so punch-drunk that we do not even know that we were hit or who delivered the blow.

The study of early British history is therefore not a mere question of antiquarian interest: it is, for America as much as for the British Commonwealth, the first and most vital step they must take if they are to wage the "Cold War" efficiently, and if they are to recover the moving force of their long-lost vision.

The first step, one of the most awkward, is also psychological. There is nothing so difficult to an adult than to question simple things that were taught and implicitly believed in early childhood. But to acquire an ability to do so has now an altogether new urgency, for as Sir Lawrence Bragg said in a broadcast during the war: there are indications that we have reached a "mutation" in evolution, a period of epoch-making change such as has not occurred since the discovery of agriculture some ten thousand years ago. And he added that the only reason why we have not got there earlier in time is that intellectual pride and obstinacy have blocked the development of knowledge. Events are now moving so fast that we have got to overcome this pride in order to keep up with them and avoid being overwhelmed, no matter how much they may shock our conservative susceptibilities.

For example, we have been taught to regard all pre-Christian religions as pagan and heathen and so all equally bad. It is therefore extremely difficult for us to realise that the fundamental difference between pagan Greece and pagan Rome was exactly the same difference as divides the modern democracies from totalitarianism. How much indeed do the British Commonwealth and America realise to-day that the war between Ancient Britain and Rome in the first century was fought for identical principles as the two world wars of the twentieth century! The usual idea of the Roman Empire is a white-washed conception as false, from the democratic point of view, as were the most fantastic ideas of a young storm-trooper about Nazi Germany. Every one who speaks of the Ancient Britons as "woad-painted savages" or "naked barbarians" is doing the democratic cause as much harm as those who repeated, as fact, what was broadcast against us during the war.

In the first world-war the Germans, having heard of the French *bifteck anglais*, published cartoons of King George V and of John Bull showing them with long fangs gnawing raw beef with the blood dripping down their chins. Had the invasion of England proved successful, British children to-day would be growing up believing that King George V and his contemporaries were savages whom the good Germans came over to civilize.

One form that hostile propaganda takes is so subtle that it is

made to appear as if it arose spontaneously within the country. This is the tendency of all revolutionary parties to disparage the immediate past of their own country for purely political ends. There is an increasing tendency for political parties to ignore the benefits and exaggerate the faults of the governments of past generations. The result is that as a new generation grows up a proportion of them are thus taught to "view their sires in the light of fools and liars," and thus they blight the roots of their own national tree.

This tendency is more clearly marked when one nation is attempting to boost its achievements by discrediting those of another. One of the greatest triumphs of that type of propaganda was when it succeeded in depriving Great Britain of all history prior to the Roman Invasion, and so to disguise completely the true meaning of that invasion. There have been many attempts to recover this lost history; but every one of those writers has come against the blank wall of intellectual obstinacy in the form of hostile criticism and the deadly inertia of official education.

The indignant T. A. Waddell is emphatic that the objectors to pre-Roman civilization in Britain "are uninformed teachers obsessed with an exaggerated notion of Roman influence."⁽²⁾

Yet we must make no mistake. They whom he speaks of as "uninformed teachers" are almost without exception the famous and recognised historical and archæological authorities. Because of their failure to distinguish between history and hostile propaganda they have ranged themselves on the wrong side in the great "Cold War," for it is they who are responsible for the fact that the dictionary states—"History is the narration of fact." It is not; for as Napoleon said:—"History is a fable agreed upon."⁽³⁾ Nietzsche declared:—"History is nothing more than the belief in falsehood."⁽⁴⁾ Professor Haldane headed a chapter "Is history a fraud?"⁽⁵⁾ and H. G. Wells spoke to a congress of teachers on the theme, "that poison called history." It was indeed not without reason and knowledge that Matthew Arnold wrote of "that huge Mississippi of lies called history"⁽⁶⁾; while Dean Inge very wittily expressed it that "the only way to be right is to prophesy after the event, like the historians, who also have the privilege, denied to the Deity, of altering the past."⁽⁷⁾

Hugh Taylor in his book *History as Science* points out that:—

If the paralyzing weight of convention and tradition is to be removed, it has long been apparent that the initial steps must be taken by someone who is free from the somewhat inordinate respect for the historians and their methods

IMMORTAL BRITAIN

The requirements of progress demand that history should be free from the restraints hitherto imposed. The human race must be considered to have attained its majority and to be capable of facing the truth.⁽⁸⁾

Hence the object of this book is to attempt to apply the principle of deep-analysis to Britain so as to bring to the conscious mind the nature of that inward wound which is festering in our national sub-consciousness ; the cure for which is essential to recover both our full physical strength and our clarity of vision.

Obviously such a task cannot be undertaken adequately by an amateur, who in order to draw a comprehensive picture must trespass into many fields which have now become so highly specialised that the President of the Royal Society says they are in danger of becoming unintelligible to one another! ⁽⁹⁾ All that the amateur can hope to do is to illumine the way ; to attempt to remove some of the rust from the Great Sword of Truth so that it may be wielded to full advantage in the cause of democracy during the final struggle with totalitarianism for the establishment of the first world-government.

CHAPTER 2.

THE OLD STONE AGE.

IT is unfortunate that some cartoonist has spread far and wide an imagery of our early ancestors as dwellers in caves. The "cave man" has become a current colloquialism and so creates a vivid but misleading conception. The hunting-men from whom we are descended did not live in caves, although like ourselves they took refuge in them from time to time. We should get a far more accurate idea of them if we compared them with the early Red Indians, and if we thought less of the stone club and more of their bows and arrows; not forgetting that it was an improvement in the bow that won the battle of Agincourt.

There were two very cold spells about 23,000 B.C. and 13,000 B.C. In between there was a period of milder conditions. During this time there were two main groups of *homo sapiens*, one somewhere in distant Asia and the other in the Sahara region. Some of the latter crossed into Italy by the Malta-Sicily land-bridge; elephants, hippopotami and ostriches coming as far north as Malta.⁽¹⁰⁾ Man and the animals then retreated south again when the second of these cold spells began.

The next phase of European development was that which followed the end of the Ice Age, and the change of European vegetation from tundra to grass steppes. As the game began to migrate into these new pastures the hunting-men followed. Some came from Asia (the Solutreans) and the others, from Africa, came up the Italian peninsula and into France and Spain. These were the Aurignacians who executed the famous cave-paintings in northern Spain and in France. Some of them penetrated as far north as Yorkshire. The period of their art is said to have extended from about 11,500 B.C. to 10,000 B.C.⁽¹¹⁾ after which they were either overwhelmed by or mingled with the Solutreans, and lost their gift for painting.

One of the earliest of their drawings, in the cave near Santandar, is of an elephant, probably a species now extinct. Just before they reached Britain the commonest animals seem to have been reindeer, mammoth, woolly-rhinoceros, arctic fox and arctic hare. The hunting-men seemed to have lived principally on the herds of bison, wild horse and reindeer.⁽¹²⁾

Meanwhile a number of other types of people began to migrate into Europe from the east. One group of these settled in Switzerland and founded there an industry which worked minute microscopic flints, known as the Tardenosian. In course of time some of the Tardenosians also found their way to Britain, and many of their tiny flints have been found in various parts of the country.

Some of these flints are only three-sixteenths of an inch long, and about sixty of them weigh less than half-an-ounce. Mr. Leslie Armstrong put a dozen perfect microliths upon a sixpence without any of them overlapping the edge.⁽¹³⁾

It is thought that they were fitted into a holder to make a scraper of skins or a saw. They could only have been made by people who had acquired an extreme skill and delicacy of touch in the working of flint. Many of these tiny flints were found at Wincobank Hill in south Yorkshire, which Mr. Armstrong thinks has been continuously occupied since about 10,000 B.C.⁽¹⁴⁾

About the same time another people, the Azilians, appeared on the Atlantic coasts of Spain and Portugal. Orthodox scholars trace them to Africa, largely because in such circles it is not respectable even to mention the word "Atlantis." This attitude of mind began as a sound reaction against the exaggerated enthusiasm of the early advocates of Atlantis (who endowed the lost continent with a civilization more advanced than our own), but it has now become an obsession rather than a serious consideration of the facts.

Orthodox science admits that subsidence on a huge scale was the primary cause of the end of the Ice Age. We have only to study the contours of the bed of the Atlantic to see that if it were raised high enough to account for the great ice-sheet a long narrow peninsula would appear running down the centre of the Atlantic. The Azores would then have formed a mountain range protecting the south part of this land from the bitter winds of the north. There is evidence that a volcano 500 miles north of the Azores erupted above sea-level about 10,000 years ago and since then has sunk as many feet.⁽¹⁵⁾ An area of land larger than Italy but not so large as Scandinavia can, therefore, be accounted for; moreover the traditional date for the sinking of Atlantis, 9,500 B.C., was known long before the geologists dated the great subsidence to about 10,000 years ago.⁽¹⁶⁾ Also, in Plato's account of Atlantis⁽¹⁷⁾, he said that North Africa and Europe were invaded by the Atlanteans on account of the sinking of their land, and he could not have known that the twentieth century scientists would

date the arrival of the Azilians on the west coast of Europe, and the second human occupation of the Nile, to about 10,000 B.C.⁽¹⁸⁾

The Azilians brought with them a flint culture of their own, one aspect of which was the manufacture of fish hooks and harpoons. Since these were of a size that suggests deep-sea fishing these people must have possessed boats.⁽¹⁹⁾ There seems no valid reason why they should not have come from an Old Stone Age settlement on Atlantis. There are many geological and botanical facts concerning the shores of the east and west Atlantic which can only be accounted for by a common origin ; nothing else can account for the origin of the Basque language. This language has no affinities with any European or Asiatic tongues, but as Dr. Farrar points out, " it resembles in its grammatical structure the aboriginal languages of the vast opposite continent, and these alone."⁽²⁰⁾

Dr. Jowett, the Victorian classical scholar, dismissed Plato's account of Atlantis by calling the great Greek " a splendid liar." This is a typical example of intellectual pride, the abuse of a highly respected but specialised position, speaking with the apparent weight of great learning on a subject on which the don could have known but little. It created a fashion in learned circles and so " blocked the development of knowledge " by putting a taboo on the subject of Atlantis. Consequently, later, a review of Lewis Spence's book on Atlantis was dismissed with withering scorn. We have constantly to be on guard to detect genuine scholarship amidst intellectual taboo.

The next phase of European development was the coming of the forests. The great herds of bison and wild horse and the hunters retreated before the trees. Many species of game died out but the men adapted themselves to new conditions and survived. In some places, notably on the south shores of the Baltic, they had to eke out a truly miserable existence, having little to eat but shell-fish for a thousand years or so. As the trees advanced the bulk of the game and the hunters must have been gradually pushed back into Brittany and over the land-bridge into Britain, and then more or less sealed off from all contact with the rest of the world. They had no axe that could cut down a tree, and had to seek sandy areas where trees could not easily grow.

In Britain groups of these three important types survived. The hunters descended from the Aurignacians and Solutreans, the fisher-men descended from the Azilians and the skilled Tardenosian craftsmen. They must have found better conditions there in spite of the very cold winters, and there must have been a fair number

of them, for the combination of huntsmen, craftsmen and seamen put a permanent stamp on British character. The right of all Britons to hunt was not curtailed until the Norman invasion, and some Old Stone Age customs lasted all through the historic period. Custom and character which have survived something like eleven invasions argue against the conception that the first permanent inhabitants of Britain were a mere handful of dull and torpid aborigines.

It is indeed by no means unlikely that London is one of the oldest continually inhabited sites anywhere on the globe. In the days when the oaks were spreading over the clay lands of England, the site of London consisted of two hills, each about 40 feet high, which had a gravel surface with a strip of sand to the north-west. They were divided by the little river Ful. On the south the hills sloped precipitously down to the Thames. On the west the swiftly flowing river Hol poured down from Hampstead between banks so steep that they might be called cliffs. (The difference in height between Holborn Viaduct and Farringdon Street gives an indication of the original height of the river banks.) Before it reached the Thames the Hol widened out and formed a natural harbour which became known as the Fleet.⁽²¹⁾ The whole area south of the Thames was largely made up of lakes and marshes, while to the north-west there was the great Epping forest.

In the Old Stone Age one of the methods of obtaining food was to decoy and stampede a herd over a precipice. Ludgate Hill in its wild state must have been a magnificent site for this purpose and must have attracted the attention of early hunters. As the forests extended and curtailed the nomadic life of the hunters, the top of Corn Hill would have been a fine site for a settlement, its natural protection being already indicated.

Unlike the hunters trapped on the Baltic shores with almost nothing but shell fish to eat, those trapped on the London site would have had an abundant food supply. For people who possessed bows, arrows, fish-hooks and boats there were vast flocks of herons, swans, geese, bitterns and duck on the fens and marshes. In the river were salmon, perch, pike, trout, lampreys and eels. Incidentally there was a nice little trout stream called the Tyburn meandering down from Swiss Cottage across Regents Park, and flowing west of Bond Street at the foot of Hay Hill across the Green Park to its delta at Westminster, and another called the Westbourne that flowed from Hampstead west of Hyde Park and on to Pimlico.

As the reindeer and bison retreated north to Scotland their

place was taken by the forest dwellers, the deer, wild cattle (*Bos primigenesis* or *paleotaurus*), elk, bears and boars. In addition there would have been many smaller birds and mammals.

We also know that there were apples, plums, pears, blackberries, strawberries, rose-hips, nuts and wild vines.

The hunting men had domesticated the dog before they reached Britain.⁽²²⁾ It is not suggesting any very great advance to think that some child, accustomed to handle puppies, might have found and adopted a gosling or piglet, but once that happened the community had taken the first step towards pastoral civilization. An apple accidentally dropped near home might have become the first orchard. Such accidents are inevitable once a nomadic people have to settle. A vine uprooted when clearing a piece of ground might take root nearer home. Once such incidents have happened and been observed, agriculture has begun. That something of the sort did take place seems the only way to account for the hunting men to have survived in sufficient numbers to leave their imprint on all succeeding generations.

It is difficult for us to get a picture of what the London area must have looked like when some unknown nomad set up his skin tent and decided to wander no more. The first Londoner could even be that hunter whose skeleton was found when they were digging the foundations of the Victoria Tower of the Houses of Parliament, so near to that of the Unknown Warrior. It must indeed have been a wild and desolate place.

It might help the imagination if we realise that not much more than a century ago the whole of the Sloane Square area was sold for twenty pounds, because the owner declared there were no longer enough snipe there to be worth shooting. Also in the 16th century the Lord Mayor and his company rode out through the farm lands of Euston to hunt the fox in the fields of Marylebone.

All over Britain there must have been a considerable number of hunting clans trapped in different places by the trees. At that time often the only site upon which Man could survive was one where the soil was too sandy for the development of large trees. Such sites were easy to clear and dry to live upon. This alone explains the use of sand in connection with fertility and burial rites, customs that lasted almost to our own day.

Mrs. Gaskell, writing of old marriage customs, said that:—

One is the custom, on any occasion of rejoicing, of strewing the ground before the houses of those who sympathised in the gladness, with common red sand, and then taking a funnel filled with white sand, and sprinkling a pattern of flowers upon the red ground. This

is always done for a wedding and often accompanied by some verse of rural composition. When I was married nearly all the houses in the town were sanded. (23)

The Countryman's Ramble describes the custom thus:—

Then the lads and lasses their tun-dishes handling
 Before all the doors for a wedding were sanding ;
 I asked Nan to wed, and she answered with ease
 You may sand for my wedding whenever you please. (24)

In the case of burial, heaps of sand are often found in old graves and tombs. Sometimes the urns were carefully deposited on a surface spread with sand. Sometimes the sand had to be brought from several miles away. It also used to be a custom in old Bristol to cover the street with sand when an inhabitant died, and "some," says Harold Armitage, "find in our custom of throwing a handful of earth upon a coffin a survival of an ancient sand rite." (25)

Other important legends and customs have come down to us from the Horned Dancer of the Old Stone Age. In fact, it is now beyond all reasonable doubt that both the Royal Unicorn and the Order of the Garter evolved directly out of this, the most ancient ceremonial known in connection with Man. The actual dance of the Horned Man continued as local custom in many country districts well into the Victorian era, and in one or two places in England it has not even yet died out. A horned dance is still performed in Staffordshire ; and in Wales there was the Mari Llwyd at least until 1913, that is the man who wore a horse's skull on his head from which a sheet fell over the wearer when visiting houses at Christmas time.

These customs probably originated in the Old Stone Age method of trapping wild animals. Wherever the ground was suitable and there was a sharp escarpment they decoyed a herd towards it and then stampeded them over so that many were killed by the subsequent fall. One or two men dressed in the horns or skin of the animals used to act as the decoy. (26) This must have been far the most dangerous part of the round-up, and one which would differentiate sharply the horned man from the rest of the clan. In the subsequent feasting and rejoicing it is not at all unlikely that he played a leading rôle in a fire-dance. He may also have taken part in some previous magical rite intended to ensure the general success of the expedition and to protect himself.

In the Cave of the Three Brothers in the Pyrenees is a drawing of a man with stag-antlers stepping this sacred or magical dance . . . At Lourdes, in France, has been found the figure of a man wearing a stag's mask, engraved on a fragment of schist . . . and upon a piece of bone, discovered in a rock shelter at Mage in France we see a drawing of men masked as chamois : and finally

THE OLD STONE AGE

a curious engraving of the Old Stone-Age, representing a masked dancer with horns was found in the Fourneau du Diable, or Cave of the Devil, in Dordogne in France. (27)

Among one of the few Aurignacian paintings found in Britain in the Pin-Hole Cave in Yorkshire was found a remarkable drawing made upon a piece of reindeer rib representing a human figure wearing an animal mask and engaged in a ceremonial dance.

Sir Gilbert Murray tells us that there used to be:

A magic dance which was to celebrate, or more properly to hasten and strengthen the coming of spring. That dance projected the "greatest of youths" who was the incarnation of spring or the return of life In our clearest and most detailed piece of evidence he (the dancer) appears with the characteristic history and attributes of Zeus. (28)

All other Gods such as Apollo, Mars, Baal, etc., came into being in the same manner. What we have to grasp and understand from this is that some young man was selected to play the rôle of the God at the Spring Festival, but that primitive people did not then regard the dancer as a man playing a part, but as the veritable God. In this regard primitive people would be like a child who believes in the reality of Father Christmas, and we ourselves as children who have just learnt that it is daddy dressed up.

Thus in north-west Europe the Spring Dance projected the Horned Dancer, and as such he was regarded not as a man but as God. When the Romans conquered France (Gaul) they called him *Cernunnos*. In Britain he came to be known as Old Hornie or Old Nick. Although the Cerne Giant of the Dorset Downs has no horns his name certainly associates him with Old Hornie, Latinised as *Cernunnos*.

By the end of the Middle Ages the Roman Church, after a thousand years of bitter denunciation and persecution had failed to drive Old Hornie out of Britain, but by then had persuaded most people to regard him as the Devil himself. But in the earlier centuries when the Roman priests were stamping out the Culdee Church, Old Hornie was still a figure so revered and honoured it would have been altogether too unpopular to have likened him to the Demon, and so instead they canonised him as St. Nicholas, who still retains his reindeers, and who, in Cornwall, still retains his horns. Similarly in Abbots Bromley, where to this day the horned dance is still performed, the local church is dedicated to "St." Nicholas.

In another form the horned dancer passed into European legend as Herne the Hunter who not only roamed Herne Hill and Windsor

Forest, but also the forests of France and Germany. By Shakespeare's time we were already beginning to dismiss our old legends as superstition, thereby engendering that type of scepticism which failed and still fails to detect the core of fact which gave rise to the legend. In *The Merry Wives of Windsor* we read:—

The superstitious idle-headed
 Eld
 Received and did deliver to our age
 This tale of Herne the Hunter for a truth.(29)

Milton, however, still took the horned dancer seriously in his masque *Comus*; and the English were so accustomed to the horned dancer that as late as 1620 A.D. he appeared on the London stage in a courtly masque by Edmund Wright, complete with horns "and a monstrous phallus."⁽³⁰⁾ But by this time the Roman Church had added hoofs, talons and tail and so had succeeded in turning Old Hornie into his opposite.

Old Hornie and Old Nick appear to have been country folk's nick-names, for throughout both Stone Ages he also bore a sacred name. This varied locally, but except in Greece, Rome and Egypt, this name was universally built up on either the consonent L or the two consonents L and N. In the former case we get the earliest Hebrew and Phoenician name for God, namely El or Al, and the Early British name Bal or Bel. In the latter case we get a great variety of names such as Alan, Allon, Balan, Belin, etc. Though we shall not attempt to go into such complex detail it is useful to realise that there are many strange but recognised variations⁽³¹⁾ such as oloma, ullanus, aolownie, olain, wallon, etc., and in the case of Bal:

	Anglo-			Old			
Sumer.	Gothic.	Norse.	Saxon.	Scot.	English.	English.	Hebrew
Bel	Baela	Bal	Bael	Bail	Bele	Blaze	Baal
	Bal	Belyse		Bele			
		Blus					

It will be found that not only have many place names come down from these words, but that there is a whole vocabulary of words derived from the Alan that all seem to have an original association with the Spring Festival.

A careful study of the map of Europe shows that such place-names seem to occur only in such parts as one would expect the hunting men to have survived the coming of the forests. For example, in N. Spain we find Villalon, El Teleno, Palencia, Catalonia, Badalona. In Switzerland and N. Italy, Walen, Hollen, Avellino, Ballenzona, Olona, Pallanza, Belluno. In France Vallon.

Allan, Avallon, Chalons, Allone, Plelan, Vilaine, Dollon, Alencon, Ballon, Allance. In Britain, except for London, they will be found only in the west and north, St. Allen, Alan river, Belstone, Point Allanus, Alanwr, Alonby, Allendale, Ballantrae, Ballenna, Alan Water, Bridge of Allan, Inellan, Tantallon, Ellon, Ballone, Balentone, Cullen, Ballan. In Ireland, Wellan, Bellanacarey, Bellanagh, Ballen temple (twice), Ballinderry, Ballena, Lake Allen, Callan, and many names which begin with Balin and Bally.

At Mount Callan in Ireland the ancient May Day festival resisted all encroachments of the Church until a very late date.⁽³²⁾ At Allendale in Northumberland a fire-dance was celebrated until quite recently. In Britain in places with modern names but which are known to have been ancient religious centres, the older name has been replaced. Thus the Be-Alan of the Dinsul, now Michael's Mount, referred to hill tops on which bonfires were lit on May Eve in honour of Beal or Be-Alan.⁽³³⁾ Glastonbury became the greatest religious centre of Old Britain, and was originally known as the Island of av-Allon, "the place of apples and the land of the Heart's Delight and renewed youth."⁽³⁴⁾ There, as in the case of the sand rites, the name was associated not only with the fertility cult, which took place on what is still called Paradise Hill, but also with the burial of the dead. The Insula-av-Allon, the Blessed Island of the West, as we know from the Arthurian legends, was the place where the kings "went west" for burial.

It is improbable that Early Man concerned himself with burial until the nomadic days were over; but as soon as they were compelled to settle by the growth of the forests, the disposal of the dead must have become a dread and terrifying necessity. From that time it becomes possible to trace out the nature of the earliest religious year.

Early observers of the American Red Indian declared that they had their rutting season as regularly as have the deer, the elk, the antelope or any other animal.⁽³⁵⁾ Even the conservative Dr. Westermarck agrees that the pairing of our earliest ancestors was restricted to a certain season of the year.⁽³⁶⁾

This alone would account for the earliest religious year with its four festivals, May Day, Lammas, All Hallows and Candlemas. The May-Day love-feast was the great day of universal freedom and equality. Even in caste-ridden India and Mediæval Europe on that day all were equal, save only Old Hornie, the leader. It is therefore very strange that it should have been revived as Labour Day.

Then came Lammas at the beginning of August. This was when the women rejoiced in the signs of their pregnancy. But it was something of an ordeal for those who found themselves barren. They were driven out to "bewail their virginity" like Jephtha's daughter.⁽³⁶⁾ Lammas was a public holiday in mediaeval times and people went out to the hill tops or mountains. In the Isle of Man and parts of Wales they say they go to bewail Jephtha's daughter.⁽³⁸⁾ It has now revived as August Bank Holiday.

Hallowe'en or All Hallows was the feast of the dead. Until the twelve days were dropped from the calendar, making Old Christmas become Twelfth Night, it was held on the 11th and 12th of November. The original festival lasted longest in the Isle of Man where Lady Wilde said it was celebrated as a sacrifice to the dead on November 12th (Old Manx style).⁽³⁹⁾ In Ancient Egypt the festival of the Death of Osiris lasted three days and began on November 10th.⁽⁴⁰⁾ It seems to be the most remarkable and mysterious coincidence of our times that this ancient festival of the dead should have revived as Armistice Day.

The last festival of the ancient year was Candlemas, originally the time when the May Day children were born. Roughly about 2,000 B.C. the solar and agricultural calendar was introduced. The four festivals of the solstices and equinoxes were imposed upon and added to the earlier year. As the birth of children became more evenly distributed over the months Candlemas lost its meaning, and the birth-celebration was transferred to the winter solstice, which became the traditional birthday of the Sun Gods.

It is not generally realised, as it most certainly should be, that about 3,500 B.C. the inhabitants of London were sufficiently advanced to have erected a Star-Temple similar to that at Avebury. The centre of the oldest stone circles were aligned to some outside stone or hill over which a rising star indicated the approach of dawn on the May-November religious festivals. It is extremely unlikely that such temples could have been erected by a people still in the hunting stage of development.

This very early date for the Avebury circle was worked out by Sir Norman Lockyer, K.C.B., F.R.S.⁽⁴¹⁾ the famous Victorian astronomer and discoverer of helium, working in conjunction with Professor Lloyd Morgan, Professor Sir John Rhys, Professor Sir A. E. Wallis Budge, Sir James Frazer and others. One would have thought the above was far too formidable a weight of learning to have been lightly dismissed. Nevertheless it has been almost totally

ignored by modern historians and archæologists who are still obsessed with the notion of the backwardness of Britain.

It has been left to the Rev. John Griffith to take up this neglected work of Sir Norman Lockyer and work out a similar astronomical date for London, and to show that the principal centres of London, some five thousand years ago, were the sites of St. Paul's Cathedral, the White Mount (Tower Hill), Parliament Hill, and Tothill—now Westminster.⁽⁴²⁾

At school and even in the armed forces to be known as a bastard is a grievous handicap. It can poison a child's life; it will block promotion to an able man. There can be few nastier crimes than to bastardise falsely, young persons and let them grow up with no knowledge of their origins. Yet this is precisely what has been done to Britain. She was deliberately deprived of all knowledge of her early history in order that she would appear inferior to others who claimed (often falsely) a long and honourable pedigree (i.e. history). It could not fail to be a national tonic to realise once again that there is no older city, no older site, than London. London life in the Old Stone Age may have been very primitive, very childlike, but it nevertheless had a vigour of its own, an essence that contained the seeds of much that is to-day recognised as the highest ideals of democracy; and also the seeds of our seamanship, craftsmanship, and sportsmanship. No other people at the end of their Old Stone Age culture were able to build anything comparable to our circles. It is time we stopped shuddering at our past like a poor little bastard being taunted at school and realised that we have a pedigree second to none in the known world.

CHAPTER 3.

THE MYSTERY OF LONDON'S PLACE NAMES.

IF we take an ordinary A.I. Guide to London we will find that it gives about twenty-five thousand, four hundred-odd street names. A rough and ready analysis of these names will teach us not only a lot about London, but also about the character of the Londoner. There are those who sneer at us for being "a nation of shopkeepers," but in London there are barely eighty street names specifically referring to trade, or about 0.31% of the total; and to obtain these we have to include such names as Clerk Street, Quill Street, Beer Lane, Drover's Road, and also the Bakers and Millers, some of whom may not refer to trade at all.

Even more unpopular are names from the Old Testament of which there are about thirty only, or 0.12%. Taking those streets bearing Christian names as opposed to surnames we find that French influence is about 0.12%, Gaelic and Welsh 0.43%, Anglo-Saxon 0.51%, Latin including Victoria 0.70%, Greek and New Testament names including all the saints and Alexandria 0.87%, German including the Georges 1.30%.

The great expansion of London from being the capital of England at the time of Crecy to that of a great Empire in 1918, is commemorated in only about one hundred and thirty names of victories and great commanders, and these include names of the defeated such as Botha and Napoleon. Surely nothing could be more indicative of the non-aggressive character of the British. There are actually twice as many streets named after birds and animals. Some two thousand streets or 7.81% of the total are called after trees, grass or flowers.

The largest proportion, but far too complex for even a rough percentage is that of the names commemorating the actual owners of the land at the time of building. These preserve innumerable historical facts which otherwise might have been forgotten. For example: Blackfriars commemorates the monks whose monastery has completely vanished. Winchester Street is all that is now left of the once great palace of the bishops of Winchester, in Southwark. Fleet Street recalls the once important mouth of the river Hol which has now become a mere underground drain. Moorgate and

Fenchurch remind us that in far-off days the city was built on the edge of fens and moors.

Throughout the Middle Ages until about the time of Queen Elizabeth I, Midsummer Day was one of the great yearly festivals. In those days London's Lord Mayor's show was called the Midsummer Watch. Midsummer, Michaelmas, Christmas and Easter were the four main festivals of Bronze-age Britain, but they have left practically no stamp upon London's street names. All the Michael's and St. John's put together only amount to about seventy-six names or 0.30% of the total.

It is therefore very remarkable to find that the far more ancient festivals, May Day, Lammas and Hallowmas should be so clearly marked on the maps of modern London. May Day and Lammas with their Fair Fields and Lovers' Lanes, etc., account for no less than 1.51% of the grand total. They will be found in groups usually near one of the London Crosses, and always in conjunction with place names derived from the roots Al, El or An, which latter account for 2.25% of London's place names; that is to say that 3.76% of existing names commemorate directly or indirectly these two Old Stone-Age festivals.

Generations of London children have been given the anti-British, pro-Roman education, which attributes the building of London and its bridge to the Romans, and yet there are only ten or eleven streets named with the names of great Romans, and they are tiny modern streets miles from the old city: there are only about eight called "Roman Road" or "Way." By way of contrast, although the groves were so bitterly condemned in the Old Testament, by the churches, the Puritans and the narrow non-conformists, there are over six hundred and fifty groves in London, such as Oak Grove, Oakbank Grove, Oakland Grove, Bal-ham Grove, Bel-ford Grove, Bel-Grove (with its corruption Bel-grave), Bel-Tree Grove, Bel-Mount Grove, El-don Grove (El's Tree Gardens), Eden Grove, Love Grove, etc.

May Day was the great feast when they went out to "inflamm themselves under oak groves," and it is still clearly marked on the maps of modern London. In Shakespeare we read of Mile End Green as a "place of games and musters." If we look this up on our maps we will find that the Green has gone, it has all been built over, and all that is left is a tiny little street called Mile-End Lane, where there are still a number of small sports grounds and playing fields. Its earlier character will be found in such names as Mayfair

Road, Fairfield Road and Fairfield Close. Leading up to the Fair Grounds from the south is Lammas Road, and north east we find Pleasant Road and Folly Lane down which we pass to Cherry Hill, past Lark's Hill and Nightingale Lane to Forest Glade, and then east over Oak Hill along Sky Pearls to Kingfisher Pond and so to the Mayfields and Mayfair Gardens of Wood Green.

Thus in tiny street names the character of Shakespeare's Mile End Green has been preserved for us as clearly as bees in amber and we can—just from these names alone—picture to ourselves the old May Day Fair, and at evening time the lads with their pockets full of new fal-dals and ribbons, leading the lassies to the love-groves, down green lanes heavy with the scent of may and lilies of the valley, to a grand chorus of larks, thrushes, blackbirds and nightingales.

In Shakespeare's day London had been Roman Catholic for a thousand years, and First-Century Christian for some four centuries before, and for about fifteen hundred years earlier still under the solar religion associated with the Druids. Nevertheless it is the older Old Stone Age religion which is the one that is so clearly marked.

In Tudor times, and in fact until the Puritans denounced the May Pole as a "heathen idol" the May Day celebrations were as an important a national event as Christmas is to-day. Henry VIII as a young man used to go out from El-tham Palace to join in the May Day sports on Shooter's Hill. On the modern maps if one goes north from El-tham Hill past Lovelace Green (Lovelace meaning a well-mannered libertine) one comes to Allen's Wood and the May Day Gardens on the edge of Woolwich Common. Then going north-east to the May Place on Shooter's Hill one comes to Nightingale Place. Beyond that in the old days there must have been a large forest extending from Bostall Wood, Abbey Wood, and Abbey Grove on the east right round to Wood Row and Wood Hill on the west. Going north from May Place down Brook Hill or Sandy Hill in the very centre of the woodlands one finds the Groves; Chester Grove, Arthur Grove, Burrage Grove in Wal-mer on the east centre, and Fairfield Grove and Maryon Grove on the west and in the heart of all Bell-son Road and Bel-ford Grove.

South of Greenwich on Black Heath (in the midst of Lewisham) is a great Bel Mount also surrounded by a Grove. On the north is Ashburne Grove, Guilford Grove, Dartmouth Grove, St. Stephen's Grove; and on the east Eton Grove and Bel-mont

Grove. Leading up to it from the south through Nightingale Grove and Limes Grove and Mercia Grove is Clare-don Rise.

Found in connection with Bel, which was the name of the old God and his Groves, the word Clare is strangely significant. The lighting of bonfires was always a part of the ritual of the ancient festivals, and one popular old name for the sacred fire was Elmo. But we learn from the dictionary that Elmo's Fire was also known as the Fire of St. Elias, of St. Clara, of St. Nicholas and of Helena. (Helena was the sister of the Heavenly Twins in Bronze Age Greece, St. Elias is the Christianised form of the God El, see note 252. Clara was patron of Lammas, August 9th and 12th.)

If we now go right to the other side of London we shall find traces of another Sacred Hill. Mount Syon or the Mount of Stone belongs to the late Stone Age and was dedicated to the Great Mother who was both the mother of the Horned God and, as Queen of the May, his bride. Owing to the many invasions of Britain and the many different languages that came to be spoken in different parts of the country, a complex and bewildering variety of names had arisen for her by the time our legends were first written down (see note 85). One of the names for the Great Goddess was Bridget which, like so many of our Gods and ancient heroes, was eventually canonised by the Roman Church to disguise her antiquity and her real meaning. In a half-Christianised form the ancient festival must have been celebrated at Mount Syon throughout all the centuries until King Henry V founded, at Syon, an abbey of the Order of St. Bridget. This abbey was then organised on Stone Age principles. There were thirteen monks. This was the magical number such as we find in the stone circle at the "Plain of Adoration in County Cavan where there were twelve pillars of stone and one of gold." At Syon there were seventy-two nuns as well as the thirteen monks, all under an abbess, and in the original charter all were to live together. Clearly this mixing of the sexes was not Roman in origin but had its roots in what one would have supposed at that time to have been the forgotten structure of a Druidic religion. (At the dissolution of the monasteries under Henry VIII Syon became the property of the dukes of Northumberland.)

It is to be noticed that Syon Hill is on the edge of another great grove. Such a grove, as we know, was not only associated with Bel or Baal worship but also with the Druids. Here it is still called Spring Grove with its modern streets Grove Road, The Grove. Then to the east south of Staines High Street is El-mer Gardens Grove Road, Bell Road and due south in Twickenham is another

Bel-Mount standing in the midst of the six streets called First Cross, Second Cross, Third Cross, etc. There is also another Clarendon and a sacred well, Ful-Well, with Mayfair Avenue and the May Road in the midst of Pope's Grove which covers a whole district. South over Strawberry Hill we will find Grove Gardens, Grove Terrace and the Grove near which is the Old Ferry and just across the river on Ham Common is Lammas Road.

If we go nearer to the city, at Notting Hill Gate we shall find another great grove, on the north-west Westbourne Grove, Blagrove, Ladbroke Grove, and on the south-west Wood Lane leading to Lime Grove and Hammersmith Grove. In the centre is Clarendon Cross in Avondale and Helen's Gardens at Walmer. Similar groups of names will be found around the May Cross at Wimbledon, the Ala Cross at Ealing—old spelling El-ing—the Cul Cross in Mayfair, the Star Cross in Euston Grove, the Cul Cross at Highgate, at Whipp's Cross on the edge of Epping Forest, north of the Seven Sisters ; and again at Elmer's End in Merlin's Grove of Eden Park.

Let us now go to the city itself and cross the river to the great Commercial Docks and the densely built-up areas of Bermondsey to Lambeth, and here again we shall find how the street names preserve the long-lost character of the once wild country as well as that of the old religion.

If we leave the city by Bel's Gate—now Billingsgate—and walk east along what was once Love Lane and across the river by the old Ful-ford we shall find ourselves in Paradise Street. But we shall have to go some distance across what was once marshland before we reach the Groves by Evelyn Street. Grove Street, Chiltern Grove, Suffolk Grove, Helena Road in the Oldfield Grove south of which is Woodpecker Road. East along the Old Kent Road is Lovelinch Street, Sylvan Grove, Cole Grove, Love Grove off Avon Place. Bel-fort Road and Evelina Road pass Vivian Grove to Nunhead and Linden Grove and on to Bell Wood and Honor Oak, or else to Bell's Garden and Paradise Place in Lyndhurst Grove from which Bellin-den Road and Avondale Rise leads to Grove Vale and a number of other Groves.

If we go back to Love Grove in the Old Kent Road and go north along Willow Walk to Mill Stream we come to Curlew Street, and west past Maze Pond near Balin Place and Avon Place we shall find Bittern Street and further west Upper Marsh and Lower Marsh. South of the marshes is Holy Oak in Fairfield's Grove leading to Old Paradise.

Old Paradise must have had some deep significance as well as being one of the finest sites around London, otherwise the Roman archbishops would not have appropriated it for themselves to build their huge palace and exclude the public.

It is not to be assumed that these innumerable names could possibly have been directly associated with specific patches of land for thousands of years. Such names now found around Notting Hill were certainly not there in the early 18th century for that area was then Mr. Green's farm with the ten-acre field, the dung field, the bowling green, etc.; other similar areas, especially in earlier times, would certainly seem likely to have been more or less nameless stretches of woodland, moor or marsh.

If therefore we ask ourselves how on earth such names were revived during the great building epidemic of the past century, the best answer seems to be that given by Augustine Birrell in one of his essays :—

There is a deep rooted paganism in the English people which is for ever bubbling up and asserting itself in the oddest of ways.

It would appear, however, to be a much sounder instinct than is suggested by the use of the word "paganism," for orthodoxy has come to use the word in such a way that it is a disguised form of totalitarian propaganda. It is this same instinct which reveals the fundamental cleft between Labour and Socialism. The former with its basic demands for the rights and freedom of the individual and its ideals of fair play is as old as Britain, but the latter is a foreign importation which is basically totalitarian in principle.

It is possible that it was this same instinct which chose May Day as Labour Day. But if the revival of the old Feast of the Dead as Armistice Day is not a coincidence, then there must be some mysterious force at work which is outside the field of present-day scientific investigation.

When one realises that the religion associated with May Day and the Love Groves of Bel was, in the eyes of the Roman Church and the later Puritans, the worst of all forms of Paganism, it is indeed extraordinary to find so many modern names commemorating that which had been severely forbidden for so long. It is however clear that in the neighbourhood of the old river Hol there are certain of these place-names which must be of an immense antiquity. At the time of the building of New Oxford Street the Old Bel or Old Bel-ton became Endel street. Old Bal or Bale has become the Old Bailey. Billingsgate is either the Gate of Belin or the Gate of Bel-ing, i.e. son of Bel. Near the Ful Gate there is

still a Holy Well and close by Old Nick or Old Nichol of Barnet Grove and Old Bethnal Green through which once ran the little river Ful; Fulbourne Street and the Ful-ford are on the south bank. Lastly there was Old Pal or Pul which became the cathedral for so long known as Old St. Paul's, and which may have been a Sacred Tree in the Old Stone Age that was replaced by a Sacred Stone according to a common pattern of evolution found all over the world. A suggested evolution of Old Paules will be given in a later chapter.

If we drop such modern words as fair, park, street, lane and also the earlier Anglo-Saxon suffixes -ham, -ton, and -ing, we shall find that a large number of London's place names were originally simple three-letter words. Such extreme simplicity is not easily paralleled elsewhere and in itself points to very early associations.

[The following are a few examples: *Ala-Alan-Alie-Al* (the old spelling of Aldgate, as in *Al-ston*). *Bale-Balin-Bel* (as in *Bel Grove*, *Belgravia*, *Bel Mount*, *Bel-ton*). *Bellin*. *El* (*Ealing*) *El's mer*, *El's tan*, *El's Tree*. *Ellen*, *Ellon*. *Fel* (*Fel-stead*, *Fel-ton*). *Fol* (*Fol-gate*). *Ful* (*Ful-ford*, *Ful-ham*, *Ful-well*). *Hal* (*Hal Crow*, *Hal-don*, *Hal-ing*, *Hal-stead*, *Hal-ton*). *Hol* (*Hol-born*, *Hol-brook*, *Hol-ton*, *Hol-wood*), *Hollen*, *Holl-ing*. *Il* (*Il-ford*, *Il-ton*). *Kil* (*Kil-burn*, *Kil-ton*). *Mal* (*Mal-don*, *Mal-ford*). *Mel* (*Mel-bury*, *Mel-ford*, *Mel-ton*). *Melin* (*Merlin*, *Melina*). *Mul* (*Mul-grove*, *Mul-ton*). *Pal* (*Pal-grove*). *Pel* (*Pel-don*, *Pel-ham*). *Pul* (*Pul-ford*, *Pul-ross*). *Sel* (*Sel-bore*, *Sel-croft*, *Sel-hurst*). *Sel* (*s-don*), *Sellon*. *Sul* (*Sul-grove*). *Tel* (*Tel-ford*, *Tel-ham*, *Tel-grove*). *Wal* (*Wal-brook*, *Wal-deck*, *Wal-don*, *Wal-ham*, *Wal-ton*). *Wel* (*Wel-bourne*, *Wel-bury*, *Wel-ham*, *Well-don*.)]

Some of these names arose from the oldest of all religions the "tree and pillar" cult that evolved from the May-Day festival; very few of them appear to be either Welsh or Gaelic, and they appear to be far older and simpler than the Celtic languages. We have always been told that the original inhabitants were driven west and north by successive invasions, and are now only to be found amongst the so-called Celts—the Welsh and Gaelic-speaking peoples. But these ancient London names point to a continuous occupation with a basic continuity of religious custom. They therefore suggest that the mass of the original inhabitants of the London area were never shifted by invasion; that, conquered again and again, they retained a certain independence and gradually tamed and civilized their enemy occupiers. Such indeed is the underlying pattern of the social structure of London which is unique

in human history. Until the great expansion of the last century and a half, London was the only capital city whose citizens retained such rights of freedom and independence that no king or central government could reside within the city boundaries, not even the apparently all-powerful Normans and Plantagenets. In this respect it is interesting to note that the "tree and pillar" cult under the prophets, always tried to resist the rise of kingship, as is so clearly shown in the story of the conflict between Samuel and Saul.

This indicates the immense antiquity of the custom whereby our Queen may not enter the City of London without first obtaining ceremonial permission.

Mr. Winston Churchill, in his famous address to the United States Congress and Senate during the Second World War, stated that:—"He must indeed have a blind soul who cannot see that some Great Purpose or Design is being worked out here below, of which we have the honour to be faithful servants."

The astonishing revival of the long lost Edenic place names in modern London is surely an indication that this great city is being prepared by "Beings immeasurably beyond our mental level," to play a leading rôle in the coming Aquarian or Messianic Age?

CHAPTER 4.

THE GREAT MOTHER.

IN the 18th century and even later when children were taught the history of England from the standard works of those days, they were told that two hundred years after the Flood, Noah's son Japhet planted a colony in Britain, which he named Samothea. Japhet was succeeded by Magus, Saron, Druids and Bardus. Bardus was subdued by Albion, a giant, who called the island after his name, and reigned forty years until he was slain by Hercules.

By the Twentieth Century these ancient legends were dismissed from the sphere of history, scornfully, in the laudable obsession for verified facts. Nevertheless the old legends are in some ways as useful and reliable as historical evidence as the exact finds of archæology. Not, of course, if taken literally, but when thoroughly dissected and studied. The one will always be needed to keep the other in balance. For example, the above legend shows that at some time early British history underwent the same treatment as the long-lost Messianic Scriptures which underlie our Bible. Both passed through a severe puritan censorship,⁽⁴³⁾ so that they were actually turned into their opposite.⁽⁴⁴⁾ Both early histories were made to begin with the Jews and end with Roman domination. *The Cambridge Ancient History* says of the Old Testament :—

There are strange gaps ; something has been deliberately passed over, hushed up, and allowed to fall into oblivion.⁽⁴⁵⁾

This applies equally to the history of early Britain. It teaches us to keep constantly upon our guard in dealing not only with our folk-lore and legends but also with orthodox history and archæology. In all cases alien elements need to be searched for and weeded out, before we can start to fill up the strange gaps and so get down to bedrock.

All mention of the Great Mother is omitted from the Bible. This in itself exposes the existing texts as priestly propaganda masquerading as divinely-inspired history, for it was not the male but the female who was predominant in the early days both in the religious and the social spheres.

In the popular film *Bambi* a majestic stag is shown as the leader of the herd in the forest. That the male is the natural leader is a common and romantic delusion. It has arisen in a

male-dominated urban civilization which has no knowledge of woodcraft and has lost touch with nature. On this subject Dr. Robert Briffault writes :—

Whatever view we may take of the respective intellectual capacities of men and women under modern conditions they are quite inapplicable to animals, and also to primitive humanity In the practical sphere which is alone of importance in the most primitive conditions there is no masculine superiority The female is the more cautious, wary, ingenious and sagacious, while the male is reckless, incautious and often stupid in comparison.(46)

Thus

among ruminants, especially the deer, the leading animal which guides the band and watches over the safety of the others is always an old experienced female.(47) The same thing will be found among the reindeer(48), the buffalo(49), wapiti (50), african antelopes(51), gazelles (52), chamois (53), elands(54), zebra(55), seals (56), and elephants.(57)

Thus the majestic stag of the film is quite untrue to nature and clearly reflects the human male's puffed-up pride in himself. We do not know very much about social life in the days when the female ruled over the males, but one cannot help wondering to-day if the threat of atomic war would be quite so serious, if it were the law in all countries that only women with children could wield the directing power that goes with Cabinet rank?

In almost all primitive societies the head of the clan was either a pregnant woman or one with a young child.(58) There are exceptions as among the Australian aborigines. It is, however, interesting to note in cases where male dominance began in primitive times there is no further cultural advance. In communities where the hunting life evolved directly into the pastoral a patriarchal and polygamous society arose. In these cases male rulership usually resulted because the man is the natural controller of flocks and herds. Once again there is no further cultural advance. There is, for example, scant difference between the household of Abraham and that of a Twentieth Century desert sheik.

The reason for this is quite clear, but it is not obvious to us because it is contrary to our accustomed way of thinking. When men fall sick or get hurt in their homes they instinctively turn to their womenfolk for first aid. In primitive societies, where there are no doctors, the full responsibility for the sick and wounded remains with the women. Hence we find all over the world that primitive women have a considerable knowledge of wild herbs and their medical uses. Far into the Middle Ages the great lady's

herb-garden was the sole source of such medical remedies as there were, except for the old woman of the village with her wild herbs who eventually came to be feared as a witch.

It was because of the women's keen observation of and experiments with herbs that it was the female and not the male who first discovered that certain wild grasses could be eaten. Therefore the discovery of agriculture is due to the female and not to the male. Dr. Briffault gives detailed evidence from almost every country in the world to show that the women actually built the first permanent huts. They were responsible for the design and building of the first temples. Similarly, they were the first makers of pots. It was they who learnt how to make skin-scrapers to soften and cure furs and pelts, and invented bone needles to sew them together into garments. They also discovered how to grow flax, to weave and later to spin wool.⁽⁵⁹⁾ In the early days of agriculture the women did all the work in the fields, the sowing and reaping. There are still tribes in which the men consider any kind of agricultural work essentially a female occupation.

Usually where very early pottery is found there are also figurines of baked clay representing a somewhat shapeless and probably pregnant woman. These figurines were man's first amulet and were connected with the worship of the Great Earth-Mother and in connection with the earliest agricultural settlements have been found all over Asia and Europe.⁽⁶⁰⁾ Not many have been found in Britain. By far the most important was the seated figure found, together with a carved phallus, in one of the shafts of Grimms Graves in Norfolk.⁽⁶¹⁾

Hence all the great agricultural civilizations Sumeria, Egypt, Crete, Britain, Greece and Rome arose from clans under the leadership of women. The first private property in the form of huts, pots and patches of cultivated land belonged naturally and exclusively to the women. The men continued to be hunters. Thus as agricultural civilization developed the male came to be economically dependent on the female and for a very long time was her social inferior.

The rise of the male to dominance over the female always began in the religious sphere. The prophet gradually replaced the seeress and the priest usurped the functions of the priestess. However, as Dr. Mosso tells us :—

At the dawn of civilization woman shed through religion a light so brilliant that the figures of males remain ignored and in shadow.⁽⁶²⁾

On the great Cretan sarcophagus of Haghia Triada the

sacrifice is being performed entirely by women, the men being attendant musicians and porters. (63)

Throughout the whole of the Minoan civilization which lasted some three thousand years, the male played a purely secondary rôle. Similarly in Mycean, or Bronze Age, Greece was Cretan in origin. It is from there that we find traces which tell us the nature of the social life in the days of the Great Mother. Among the Spartans, girls were unrestricted both in their social and sexual relations, and even in the later classical period the majority of the children were called *parthenioi*, that is "virgin-born" because they had no fathers. (64) "In Sparta," says Polybius, "several brothers had often one wife between them, and the children were brought up in common." (65) It was also the custom to exchange wives and to offer them to strangers. (66) The wives, on the other hand, had a recognised right to take "secondary husbands." (67)

Current tradition in classical Athens represented that in earlier times the form of marriage and the status of women had been entirely different, and that in those days there were "no fathers." (68) Indeed far into the historical times fatherless men, like Plato, were still being spoken of as "virgin-born." (69)

Not until nearly five hundred years after the fall of the sixth and last city of Troy and more than five thousand years later than the first settlements of London, do we come to the traditional date for the founding of Rome. There again communal marriage was at first the legal institution among the Etruscans, (70) and in the Etruscan tomb inscriptions there is no word for father. (71) At the dawn of Roman history the kings and nobles were, like the Spartans, virgin-born. (72)

In the early days of the Republic women were still fully equal to men, both socially and politically. But in Rome, as in Greece, the custom of patriarchal marriage was introduced in order that a man should not have to share his money with his mother's clan and also that he might deprive the clan of its right of inheritance by passing the wealth direct to his son. The Romans were by no means particular as to who was the actual father. This we know from the account of the second Cato sharing his wife with Quintus Hortentius, (73) and the indifference of emperors like Claudius and Marcus Aurelius to the behaviour of their wives. Moreover when patriarchal marriage was first introduced, it broke down utterly during the great religious festivals when all distinctions of caste

and family were put aside. During the Saturnalia even Roman slaves had complete freedom and consequently there must have been considerable doubt as to the actual paternity of many a son and heir. The mother of Augustus Caesar always declared that "she got him with a serpent in the groves of Apollo,"⁽⁷⁴⁾ which shows that illegitimacy still conferred a definite social distinction. Nevertheless as patriarchal marriage became the firmly established custom of the ruling class, the Republic, i.e. the democratic way of life, collapsed; Rome became an absolute totalitarian government under the God-Emperor; thereafter wars of expansion and plunder became the principal object of government.

It is therefore clear that the fact that the Ancient Britons had their wives in common is no indication of savage or backward conditions as has so often been contended. The fact that Britain resisted the patriarchal form of marriage longer than any other European country is a main reason why the principles of democratic government did not die out altogether in Europe. Moreover in their resistance to the patriarchal way of life our ancestors were not only wiser than we credit them, but had the full support of the greatest known intellects of the Ancient World.

We recognise even to-day that Socrates and his pupil Plato still rank among the greatest thinkers of all time. Plato is one of the last writers whom we can accuse of loose morals or a licentious outlook. Moreover, unlike any modern thinkers, Socrates and Plato had actual experience of both the old matriarchal promiscuousness and patriarchal monogamy. It is therefore of great importance to us to realise that

Plato in disgust at the product of male proprietary morality, turned back as to an ideal to the primitive Greek social order such as survived in Sparta and advocated sexual communism.⁽⁷⁵⁾ So did both the Cynics⁽⁷⁶⁾, and the Epicurians.⁽⁷⁷⁾

How right they were we can now realise from the fact that the rise of patriarchal morality resulted in the total destruction of Greek civilization. It is essential to understand these facts and keep them in mind in order that we may obtain a true evaluation of Ancient British civilization, the heights to which it rose and its almost total obliteration by the Romans.

One of the fascinating mysteries of Ancient Britain is the reason why they called the places where they held the great Spring Festival, "Paradise" and why they called the Sacred Mount in Scotland—king Arthur's seat in Edinburgh—the Rampart of Eiden;⁽⁷⁸⁾ also why they likened the Sacred Island of Avalon to the

Garden of Eden.⁽⁷⁹⁾ It is possible that if any of our remote ancestors could re-visit the earth to-day they would say that the whole of our recorded history is the story of Paradise Lost, and that our only hope of the future would be to discover some sensible means whereby we could create a new social order that would at once be recognised as Paradise Regained.

There is no doubt that in the Ancient British version of the story of the Garden of Eden, our Adam was the Horned God and our Eve the Great Mother. Every spring the people gathered together and went up the Hill of Paradise to watch the Sacred Wedding. Thus for countless generations they were accustomed to the spectacle of a naked man and woman performing their solemn ritual beneath the branches of the Sacred Tree or Tree of Life. This yearly pageantry kept fresh in men's minds the belief that they were all the Sons of God. Then for some reason, for which no account has yet been rendered, all memory of the great British Garden of Eden was allowed to fade from memory, and in its place we were taught that the first man and the first woman were two Jews who on account of their prudery brought down on our heads the Curse of God and banishment from Eden.

It is however clear enough that with the rise of patriarchy the Great Mother gradually ceased to be Man's primary conception of deity and was replaced by various types of Father-God. But throughout Europe, with the sole exception of Old Hornie, no figure of a male God was known before the rise of the Bronze Age.

In Britain, owing to variations of language, dialect and spelling, the Great Mother came to have more than thirty names. The name which appears to have been the earliest was An or Anu —Bu Anu, the Good Mother.⁽⁸⁰⁾ The union of the Horned God under the name Al and the Virgin Mother An is one reason why the Sacred Tree and Sacred Mount both came to be called Alan or Allon. In Old English there was a verb "on alen" which means to inflame or enkindle to passion.⁽⁸¹⁾ In both primitive and masonic symbolism the male Al is depicted as ✱,⁽⁸²⁾ and the female An as a fish's mouth ◊,⁽⁸³⁾ and the union of the two forms the symbol for the Great Saviour of Life on whom all depend.⁽⁸⁴⁾ ✱ or ⊕

Another famous Ancient British name for the Great Mother

was Briget or Brigantia, in Gaelic Bride,⁽⁸⁵⁾ and also written Brig, Brid, Breed, Bridget. Britannia is not, as some sly enemy suggested in the *Encyclopædia Britannica*, derived from a Roman Goddess; she is the Great Mother, and many of her symbols were already hoary with antiquity before Romulus and Remus were suckled by their wolf-mother. As far back as the time when she was called Anu she ruled the seas.⁽⁸⁶⁾ The lighthouse on our modern pennies still reflects the rôle of the clan-mother keeping alight the sacred fire. On our modern paper money she is depicted holding an ear of corn showing her as the Goddess of Fertility or Earth-Mother. One of the great mysteries of modern life is how the crosses on Britannia's shield re-form the ancient symbol of the Great Saviour, the male Al within the female An. Her principal festival was Candlemas Eve which was originally the time of birth following the May Day festivities. This accounts for the somewhat surprising fact that when she was disguised as a saint to hush up her true meaning she was sometimes shown blessing the womb of a pregnant nun.⁽⁸⁷⁾ Similarly in France we find the Great Mother Anu surviving to this day in the Catholic Church. At Notre-Dame de Liesse (Aisne) there is a statue of Saint Ann in the robes of a nun but clearly showing a fully developed baby in her womb.⁽⁸⁸⁾ She was not only Goddess of birth and fertility, of sacred wells and trees but also, as Sir James Frazer has pointed out in his account of Candlemas, of Fire.

Many of her centres of worship in Britain have been found: sometimes under Roman influence they were associated with Diana. The most famous of these places were the Hill of Anu in Ireland, the pre-Roman city of Bath, and on Ludgate Hill in London. There near St. Bride's Well and St. Bride's Street her Sacred Tree decayed with age and became a mere stump which was called Old Pawlie or Old Pol.

To this day every girl on her wedding day (unconsciously) plays the rôle of the ancient Goddess and is therefore called "the bride," and thereafter her function is to "breed" and to "keep the home fires burning." One of the most important things that we have to study and understand is that from the moment the male forced her to use the words "I obey" all hope of a peaceful agricultural evolution came to an end.

Gerald Heard has pointed out that:—

The association between sex and violence is *still* not generally realised.

He adds that without that knowledge

"Our species is in danger of staggering down into extinction. For, without that knowledge, we must oscillate between the *tedium vitae* of sex exhaustion, and the frantic destructiveness of the Puritan repression which end in the monomaniacal militarists . . ."

He points out that since the discovery of agriculture man has taken a wrong turning in evolution and says:—

If Man is to continue his evolutionary progress he can only do so if he "springs again from the graft It is perhaps necessary to repeat that what is being advocated is not a blind return to the past, but on the contrary, a taking up again of themes that have been prematurely neglected." (89)

Gordon Taylor in his masterly review of present social conditions says:—

. . . . I think we have to make up our minds either all values are equally worthy, or else there are good and bad values. If the latter, then the question which arises is, can we distinguish good from bad values? I think we *can*: and that there is only one acceptable system of values—that based on love. Even if one distrusts religion and despises ethics, one has to admit the bald fact that, fundamentally, only two schemes of values exist; those based on love and hate respectively. The latter generates a vicious spiral of destructive activity; the former a benign spiral of happiness. (90)

If we consider the symbolism of the Bible as a whole we see clearly that it begins with the expulsion from the Garden of Eden, and both Old and New Testaments lead on to the prophecy of a coming Messianic Age. The New Testament culminates in the great prophecy of the final Armageddon when Michael overthrows the Dragon, and so prepares the way for Paradise Regained.

There can be few to-day who do not feel that we are approaching a crisis of overwhelming magnitude, a veritable "mutation" in evolution. But does not the Biblical symbolism expressly imply that we "spring again from the graft"? The great driving force of totalitarianism is a vision—a vision of world conquest and it is based on hate. But how can the democracies unite to meet so great a peril in full strength if they have no clear vision? If they cannot differentiate between the principles of dynamic love and active hate? If they do not even understand such Biblical terms as "Paradise Regained" or "Michael"? Will those who are shocked and ashamed of the age-old traditional *nakedness* of Michael flock over to the other side? For many it will be no easy choice; let us at least remember that totalitarian states, like Germany, speak of the Fatherland, but Great Britain—over which the Great Mother still broods as Britannia—is always known as the Mother-Country.

Mother-Country, and the Twin Crosses of her shield are the oldest known symbol for the "Great Saviour of Life."

CHAPTER 5.

FREEDOM AND SLAVERY. A CONTRAST.

THE Neolithic or New Stone Age covers that epoch of human development when the hunting clans settled down to village life and grew corn, but had not discovered the use of metal. The discovery of agriculture was due to conditions of dire necessity which arose from world-wide changes in climate. These conditions must have affected many peoples in many parts of the world but it is generally agreed at present that it was only in one or two places in Asia that the discovery was made, and that the knowledge very slowly spread from there in all directions. It could only have occurred in districts where suitable types of corn or wheat grew wild.

The three earliest settlements so far discovered were at Anau east of the Caspian Sea, at Susa on the N.E. coast of the Persian Gulf and at Annu or On in the Nile Valley.⁽⁹¹⁾ It will be noticed that two of these appear to have been named after the Great Mother Anu. None of these is near where it is thought the wild corn was first utilised for human consumption. Professional archæologists have given dates for the foundation of these places which differ by thousands of years. About 5000 B.C. seems to be the opinion of the most recent writers.

That the experts could differ to an extent so extreme in countries where a dry climate has left an abundance of archæological material should be kept in mind when considering the very late date commonly held for the coming of Neolithic civilization to Britain, namely "after 2500 B.C."⁽⁹²⁾ that is, nearly three thousand years later than its commencement in Asia Minor, Crete and Egypt.

Somewhere about 7000 B.C. the spread of the forests drove the hunting men and the game they lived on over the land-bridge into Britain. Sometime later the land sank and they were cut off from the rest of the world by sea and forest. It is estimated that a hunting population requires four square miles per person,⁽⁹³⁾ or fifteen to twenty square miles to each wandering clan.⁽⁹⁴⁾ That would mean that the total population of Britain would have been limited to between 1,500 and 2,000 persons. But as the forest encroached over all the low-lying clay lands even that tiny

population would have been much reduced. According to Peake and Fleure they were

poor unprogressive food-collectors whose methods of life were comparable only to those of the Australian aborigines and to the inhabitants of Terra del Fuego.⁽⁹⁵⁾

By way of contrast to the long millenia in which Britain is said to have made no material progress Peake and Fleure give a remarkable diagram showing the rapidity of progress in Egypt: across this diagram is printed the words BARBARISM-CIVILIZATION. The words are printed with a large capital B and each following letter smaller in size until there is a tiny m-c, after which each letter increases until there is a huge final N. The large B is to stress how very barbarous they had been, and the large final N how very civilized they had become.

Underneath there are little plans of various types of graves from the sand heap and the first tomb to the Great Pyramid. Part of the accompanying text reads: Late Stone Age, metal discovered about 4000 B.C. Writing in use 3500 B.C. Earliest sea-going ships cross Mediterranean 3000 B.C. Remarkable organization of government necessary to erect great buildings The Great Pyramid 481 high. 2900 B. C. Wonderful progress in art.

Writing of Narmer Menes the first king of the first dynasty Peake and Fleure tell us that the people of the Delta

resenting the usurpation of power by Menes, left the Delta, and, if Evan's latest suggestion is correct, some of them sailed to Crete and settled there about 3,400 B.C.⁽⁹⁶⁾

All this is probably quite accurate, but it gives a totally false impression. "Resenting the usurpation of power" gives no picture at all of the stark terror and misery of the conquered people of the Delta who were to supply gallons of blood for the fearful yearly festival of the "Smashing of the Intui," when, says the *Cambridge Ancient History*, "countless human beings were sacrificed."⁽⁹⁷⁾

It was these unfortunate people, or rather their descendants, who were to build the Great Pyramid which consisted of some two million, three hundred thousand stones each weighing on an average two and a half tons. These huge stones were brought to the site on man-drawn sledges—for they had no wheel—and then manhandled into position, the top one over four hundred and eighty feet above the base. We are not told how many thousands of men died under the lash of the slave-masters before this great monument was completed. Peake and Fleure are typical of modern scientific writers in continuing to speak of the Great Pyramid as one of the seven wonders of the world. But they speak with awe as if it

indicated a tremendous advance in civilization. No one seems to realise that it is only wonderful as an example of the stupendous cruelty and stupidity that man is capable of. It is not surprising that the cause of democracy in the twentieth century is in grave peril when we are taught to admire the hateful folly of lashing thousands of slaves to death in order to raise a useless pile of stones solely because one man was afraid of being eaten when he died.

We do not know how many of the captive people of the Delta were eaten by the kings of the first dynasties after their blood had been used to fill the alabaster bowls of Ra, but we do know that they were eaten wholesale by the kings of the Vth Dynasty. The inscriptions on the pyramid of king Unas have left detailed descriptions of the pride that king took in the number of men and women whose bodies he hacked up and whose haunches he boiled in his cauldrons before he ate them.⁽⁹⁸⁾

Ritual cannibalism was a feature of Greek life⁽⁹⁹⁾ sufficiently widespread to evolve into the ritual symbology of Christianity, but it does not appear to have been a feature of the civilizations of Asia Minor or of Rome. The Romans expressed horror of religious human sacrifice but nevertheless practised it on a huge scale as their principal form of public entertainment. All these civilizations, Sumer, Babylon, Egypt, Greece and Rome were based on slavery.

These facts should not be overlooked when we talk so glibly of the contrast between barbarism and civilization. An excessive admiration for the products of totalitarianism and slavery *must* be injurious to the democratic cause. As the great slave-states arose in the near-east our ancestors in the misty islands of the north survived century after century in spite of harsh and adverse conditions. They had no axe with which to cut down trees; so far as is known there were no edible grasses within two thousand miles. Surely their grit and endurance was a far greater human achievement than driving slaves to raise huge piles of stone?

It was those original Britons with their cheerful May Day festival, their beloved Old Hornie, their sense of equality and fair play that gave us the Common Law, trial by jury, and made us, until the rise of the U.S.A., the primary if not the only centre of humanity that consistently resisted slavery and fought for the rights of man and the freedom of the individual.

Had Hitler won the Battle of Britain and so conquered all Europe he would, without doubt, have used the labour of the conquered people as slaves to erect vast buildings in Germany and then in five thousand years time future archæologists would write

of that wonderful man Hitler, just as our own do of the great slave-owing rulers Sargon of Sumer and Hammurabi of Babylon. King George VI having had no slaves left on vast monuments for future archæologists to rave about.

But though we of Twentieth Century Britain have certain rights the belief that we are a free people is a great illusion. From the age of five most of us are compelled to go to school to be conditioned to earn our living. Economic necessity then imposes a stern discipline from which the vast majority of us never escape. Until the Second World-war there were, however, among us a few who by reason of inherited wealth did have a very considerable measure of real independence. It is a noticeable fact that the majority of such people chose to spend the greater part of their lives in the manner of our remote despised ancestors, hunting, shooting and fishing. It would indeed be a very strange man who would prefer to be a "civilized" Egyptian being fattened for the cooking pot or lashed to work, rather than a free Briton hunting and fishing in his misty fens. Let us not forget that in Christian Europe their ancient way of life became the exclusive privilege of the king and his nobles. Let those who insist on upholding Britain as the bastard among nations remember that the great slave civilizations were based on hate. They set up a vicious spiral of destructive activity, and one by one they perished. It was Britain who survived to become the mother of many young nations.

CHAPTER 6.

THE GROWTH OF CIVILIZATION.

ALL dates prior to about 1500 B.C. should probably be taken with a certain amount of reserve, although there is now, with increasing knowledge, far more general agreement. About 4500 B.C. there was an elevation of N.W. Europe which resulted in an extension of the Alpine and Himalayan glaciers, and which corresponds to the flood period in Mesopotamia which separated the ante-diluvian monarchs from those of the 1st dynasties of Kish, Erech and Ur; that of Ur being dated to 3575 B.C.⁽¹⁰⁰⁾

Great floods would force man and all animals to seek refuge together on the hill tops. Doubtless such is the historical core of the Noah's Ark story. The turning of the hill into an ark or ship is a misinterpretation through ignorance of the astrological account of the constellations of Argo and the Dove within the watery sign Cancer, passing through the House of Life at the dawn of human history.

A pre-dynastic agricultural civilization lasted in Egypt—which country had no flood and no legends of a flood⁽¹⁰¹⁾—from about 4800 B.C. to 3500 B.C. when Egypt was invaded by the Horus Egyptians. This invasion seems to have been an incursion of Copper-Age folk into a Stone-Age community; a war-like people conquering and enslaving a peaceful population. It appears to have been refugees from this invasion who set up the first Minoan dynasty in Crete at 3400 B.C., and they can only have done so by means of sea-going ships.

The earliest Star Temples in Britain, therefore, appear to be contemporary with the oldest known urban civilizations in the Near East and Egypt. They cannot have been erected by poor backward savages for they were no haphazard circles of stones, but erections based on accurate astronomical and mathematical calculations, implying a division of the circle into 360 degrees. (See Note 91.)

A little before 3000 B.C. the Sumerian city-states fell to invaders from Russia. This invasion drove many agriculturalists westwards out of Asia Minor. Three groups migrated to Europe. One crossed the Aegean and settled in Greece, another settled along the upper waters of the Alt in Rumania, and a third came to the plains of Hungary. These last cultivated grain, and had a number

of domestic animals which included short-horned cattle, marsh-sheep and pigs.

No spears, arrows or other sporting or warlike implements have been found and the only weapons hitherto discovered on those sites are disk-like mace-heads of stone. (102)

These, as we shall see later, were used for ceremonial and religious purposes. They made quite elaborate pottery. They mined gold and as early as 3000 B.C. exported it to Egypt by ship, probably via Crete. Wherever the soil was sandy they built villages of small oval huts partly sunk in the ground.

There was a humble fishing settlement at Troy—the first city of Troy.

About the same time Zoso the second king of the third Dynasty of Egypt erected the first stone temple and the first pyramid. A hundred years later Snefru founded the Fourth Dynasty and his successors built the great pyramids of Giza. This was the period known as the Old Kingdom.

About 2750 B.C. Sargon of Agade united all the Sumerian cities under one rule, by the usual method of conquest. At the same time the priests of Egypt usurped the royal powers and established the Fifth Dynasty, that of the cannibal kings.

Beginning about 2600 B.C. the whole ancient world fell into a turmoil resulting from another invasion from Russia; Anau and Troy were destroyed. Mesopotamia was invaded and laid waste. The Sixth Egyptian Dynasty collapsed, and the Old Kingdom came to an end.

Europe was invaded by the battle-axe people and her peaceful civilization overwhelmed. The invaders appear to have made themselves overlords of the Danube peasants and lived off their labour. Like all pastoral and nomadic people these invaders despised the agriculturalists. This cultural pattern was to repeat itself time and again in Europe and underlies the whole conception of the mediæval barons and the great landowners of the Nineteenth Century.

Many of the agricultural folk were driven from their homes and fled as refugees. Thus the westward spread of agriculture was suddenly speeded up. Some of these dispossessed persons went south into Greece and founded Corinth about 2400 B.C. A century later others having passed over the Alps reached Sicily. Yet others moved west and reached the Rhine and Holland about 2200 B.C. We do not know how wide the North Sea was at that time. It may still have been quite narrow, for sometime after grain-growing was

established in Britain the whole Island tilted over. The west coast of Scotland rose about 30 feet while that of Norfolk and Essex sank.⁽¹⁰³⁾ Anyhow as they had been connected by sea-trade with Egypt they would have had no great difficulty in reaching Britain.

In association with the spread of this peaceful peasant population there arose the custom of building villages on piles sunk in shallow water or marsh land. The main platform of the village was often some distance from the land and connected with it by a long narrow causeway of wood. The houses were built of tree trunks and consisted of two rooms with a porch, and were thatched. They were first built in the earliest Neolithic period and the finest pottery belongs to that time. Many of them remained in occupation throughout the whole of the Bronze and Iron Ages. Only one survived to become a world famous city, namely Venice.

Lake Constance, where many of these Neolithic pile villages were built, was at one time called *Lacus Brigantinus*, or the Lake of the Brigantii, and the town of Brienz on the south-eastern shore was *Brigantium*.⁽¹⁰⁴⁾ Similar villages were built on many sites along the valley of the Rhine, and they appear again on the coast of Yorkshire at Holderness and several other sites. The Brigantians were the largest of the pre-Roman Clans and occupied Yorkshire which still remains the largest county. Doubtless they were the especial people of the Great Mother under her name Bridget or Bride. These Yorkshire lake villages, like those at Glastonbury, were at one time thought to be no earlier than about 200 B.C. It is now known that the lower part of their structure was entirely made with wood, upon which only stone tools had been used, which places their origin back in the Neolithic epoch.

Europe remained under constant pressure of migratory invasion from Russia. The pile lake-dwellings of the Rhine valley were abandoned and the people took to living on hill-tops behind rough fortifications of earthenwork. Doubtless the same pressure which drove them from their homes to the hill-tops would also have caused others to flee westward to Britain.

About 2400 B.C. the second city of Troy was built and fortified with walls. There are reasons to believe that Troy was not a rival sea-power to Crete but a Cretan colony and part of the Minoan civilization. Virgil makes it quite clear that the Romans had no doubt on this point.⁽¹⁰⁵⁾ Sea trade was established between Troy and Greece, Sicily and the Adriatic, and overland up the Danube into Bohemia and Saxony. By 2200 B.C. this sea-trade had extended not only to Sardinia and the Balearic Islands but to the

South of France, Spain and even Portugal. A century later the Trojans reached Britain by way of the sea.⁽¹⁰⁶⁾ Thus the early date for the sea-trades between Britain and Troy as estimated by Lord Avebury, Sir John Evans and the Abbé Fontenu, and hitherto despised, has now not only been confirmed by orthodox archæology but even pushed back.

It used to be thought that the culture of the Beaker-folk reached Britain from Spain but, as Peake and Fleure point out, it is more likely that it arose in Eastern Europe and spread westwards in all directions in conformity with the general pattern of European development, which was still overshadowed by the results of the invasion of the battle-axe people.⁽¹⁰⁷⁾

Windmill Hill near Avebury was occupied as a settlement about 2100 B.C. A similar settlement has been found at Maiden Castle in Dorset. Both settlements take on this character, similar to that along the Rhine, where an agricultural people were driven from their homes to try to live on fortified hill-tops. Only an agricultural and pastoral people could have survived for more than a few months on such bleak sites and would not have done so from free choice. Moreover both were abandoned again after a short time, indicating that the time of danger was passed.

The Beaker-folk arrived in Britain after 2500 B.C. as invaders. Their success appears to have been due to superior armaments. They were also more powerfully-built men than the early Britons, with massive jaws. They appear to have conquered all eastern Britain and settled themselves as overlords. But as M. C. Burkett tells us:—

The Beaker folk never obtained a permanent footing in the country; after a time they simply seem to have merged with the older folk, though their influence continued to affect the original Neolithic stock which seems to have come again into its own.⁽¹⁰⁸⁾

Hence the Beaker Invasion, over four thousand years ago, shows clearly the unchanging character of Britain. There have been many invasions since, Belgæ, Roman, Saxons, Danes, Normans, but in every case they failed to set up a permanent tyranny and eventually merged with the original inhabitants, leaving the basic characteristics of the British—seamanship, craftsmanship, love of sport and justice—unchanged from the remotest times. And in this respect we should not forget that Wincobank Hill (now Sheffield) and London are probably among the oldest continually inhabited sites anywhere in the world, so far as at present can be ascertained.

Whether or no the British possessed the knowledge of the tree-felling axe prior to the Beaker Invasion is not known. The axe, however, denoted an epoch-making change from the hunting-pastoral to agricultural. According to the latest archæological estimates, this change in human affairs occurred in Britain between 2500 and 2100 B.C. These dates are considerably later than those obtained by astronomical calculation for the first stone circle, and even the most primitive circle strongly suggests agriculture. This difference in dates underlies the question whether or no the British discovered the axe for themselves. Orthodoxy dismisses such an idea as absurd; nevertheless even in our own times, with facts well established, we have often discovered things for ourselves for which other people have become the acknowledged claimants.

In some respects over-specialisation has hindered rather than advanced the science of archæology; especially unfortunate is the divorce of archæology from folklore, for the two subjects interlock at all points and neither can advance greatly without the aid of the other. As Lewis Spence writes:—

In his insistence in stripping the archæological scene of every vestige of the romance and mystery which formerly surrounded it, the modern antiquary, suffering from the credulity of incredulity, that bane of present-day science, has assuredly not accorded to the question of the Druids the investigation which its importance certainly demands.
(109)

But it is not merely the question of Druidism that suffers, it is the whole of the early history of Britain of which Druidism is but a short phase. In fact, during the last quarter of a century archæology has only added to our knowledge of the British stone circles the fact that they almost certainly were preceded by wooden circles, such as the one at Bleasdale in Lancashire and the recently discovered "Woodhenge" on Salisbury Downs.⁽¹¹⁰⁾ The poles for the wooden circles could not have been cut before the discovery of the tree-felling axe.

On the other hand for far too long under the prevailing fashion of talking of the early British as naked and backward savages, we have neglected to examine the world significance of our great stone circles. Very few people realise that Stonehenge consists of two Star-Temples, the one inside the other. The outer circle is orientated for the solar year whose principal festivals were Easter, Midsummer, Michaelmas and Christmas. The inner and far older circle is oriented to the May Day, Lammas, Hallow E'en and Candlemas festivals.

Of great unexplained significance is the fact—once thought to be a mere fairy tale—that the huge stones of the inner circle were brought to Salisbury Downs all the way from Pembrokeshire.⁽¹¹¹⁾ This gigantic task of transportation and erection could not have been undertaken by a people dependent merely on hunting for their food. The stones themselves must have had some special significance and points to their having constituted a still earlier circle in Wales. The people who transported them must have had considerable knowledge of boat-building. Those great stones were nearly twice the size they are now when they were shipped across the Bristol Channel. People who could build boats that would carry such weights could easily have built ships capable of equal distances to those of contemporary Crete and Troy. They could not have built such boats without an axe.

The original builders of the inner circle would not have transported such great stones all that distance only to chip them down to half their size after they had arrived at their new site. It is certain they were chipped down by the builders of the outer circle in order to make them conform to the new design. The solar religion was imposed upon and amalgamated with the older religion but did not supersede it. Indeed May-Day remained an important festival at Stonehenge until the Fifth century A.D. when on May Eve 460 British chieftains (the heads of the clans corresponding to the MacLeod, the Mackintosh, etc.) were massacred by the Germans (Saxons); an event traditionally known as the " Treachery of the Long Knives." ⁽¹¹²⁾

Almost to our own times (a trace of the old May-Day feast) at King's Knot in Stirling small boys stripped themselves naked and ran round the ancient mound.⁽¹¹³⁾ Until as late as the Thirteenth Century A.D. religious nudity remained the common custom in Britain. The Chronicles of Lanercost⁽¹¹⁴⁾ tell us that:—

John, priest of Inverkeithy in Fife, was cited before the bishop in 1282 A.D. for having celebrated Easter week according to the " rites of Priapus," by collecting maidens of the town and making them dance round the phallic deity, singing the while. He pleaded " common usage " of the country and was allowed to retain his benefice.⁽¹¹⁵⁾

Doubtless the old religious nudity was one of the reasons for dubbing the Ancient Britons as savages, though practised in Greece and Rome. In the Eighteenth and Nineteenth Centuries nudity was associated only with African and similar primitive peoples. Even the spread of the nudist cult in the Twentieth Century has not yet cured the majority of the superstitious fears of nakedness

which was imposed on us by the great Jewish-Italian taboo. On the other hand no one dreamt of scoffing at Alexander the Great who likewise stripped naked and ran round the Tomb of Achilles at the commencement of his conquest of Persia. In their gymnasiums, which were presided over by ithyphallic statues of Hermes, the Greeks considered anything but total nudity to be most improper.⁽¹¹⁶⁾ It would be absurd on that account to speak of the Greeks as a backward people. Therefore to use our ancient nudity as a weapon to belittle the Ancient Britons savours of hostile propaganda supported by puritanical hypocrisy.

In trying to ascertain an unprejudiced estimate of Ancient Britain one point needs to be stressed because it has been consistently overlooked. The general orthodox opinion holds that the knowledge of the axe, of agriculture and everything else associated with civilization was brought to Britain from Europe and the Near East. Even the megalithic culture is said to have spread from Crete to Malta, and thence to the coasts of Portugal and France and so to Britain.

But when a culture spreads from a given centre to distant lands its monuments tend to decrease in size and importance the further they are away from that centre. For example, when the Christian missionaries spread their faith outwards from Europe, nowhere were they able to erect cathedrals and churches to compare with the great ones they had left behind. In fact the further they penetrated into Africa, Asia or the South Seas the smaller their new churches became until often they were but huts with corrugated iron roofs.

In Ancient Britain on the other hand we find exactly the opposite occurring. As civilization spread into the far west and the wilds of "savage" Britain, the more important became the monuments of the megalithic culture until, at Stonehenge and Avebury, we reach the supreme and outstanding monuments of Stone Age culture. It does not make sense to insist that these great Stone Age "cathedrals" in the far west indicate the most backward area of a spreading culture.

If the above astronomical dates are approximately correct then the first Egyptian pyramids were contemporary with the earliest British stone circles. But the pyramid was built by slavery and is the supreme symbol of the totalitarian Slave State. Contrarywise the stone circle symbolises the exact opposite and

represents the mingling together of neighbouring clans in freedom and social equality.

It is all too customary to speak disparagingly of the Ancient British as groups of scattered tribes. It is doubtful if any Sassenach visitor to Scotland who spoke of the Stuarts, the Campbells, etc., in the same sneering manner would be at all well received. Had the English clans survived to the Twentieth Century we should be as justifiably proud of them as the Scots are of theirs. Our loss, though we still do not realise it, is a bitter one, and we owe it to the Romans and the Saxons !

Again, all our estimates of ancient civilization, particularly in the sphere of archæology, tend to overstress the material and neglect the spiritual. However justified we are in our admiration for the statues, pottery, and architecture of past races we are almost invariably admiring the products of slavery. By way of contrast all the evidence points to Britain as having been the sanctuary of freedom throughout the whole of man's known history.

CHAPTER 7.

LIFE IN NEOLITHIC BRITAIN.

IF we try to depict life in Neolithic Britain we are at once struck by the fact that whereas there was no great luxury on the one hand there was no extreme poverty on the other. Their homes seem to have been far cleaner and more comfortable than mediaeval farmhouses.

Jacquetta Hawkes tells us that:—

Far the most vivid and intimate picture of a New Stone Age community is to be found remote in the Orkneys where the stone-built hut cluster of Skara Brae has been preserved through thousands of years by drifting sand dunes. In absolute date this village belongs to the Early Bronze Age of the south, but its inhabitants had no metal and followed a characteristically New Stone Age way of life. There were some half-dozen houses consisting of a comfortably-sized room, measuring as much as 20 by 18 feet and with small side closets let into the walls. Furniture, all made from Caithness flagstone, included a shelved dresser, wall-shelving, and beds warmly hung with skin canopies: a peat fire burned on a central hearth. The huts were linked with narrow alleys completely roofed in for protection against the Orkney gales and were served by what appears to have been a communally owned workshop. Hygiene and barbarism are not often associated, but Skara Brae villagers had laid under their houses not only an efficient sewage system, but also the bodies of two old women, presumably a sacrifice.⁽¹¹⁷⁾

Since hygiene and barbarism are not often associated why associate them without evidence? Why, except to bastardise the British, assume human sacrifice without even suggesting an alternative explanation? If a skeleton be found in a man's house and you wrongfully accuse him of murder you might find yourself severely censored and heavily fined in the Law Courts. With the dead, however, it is assumed there can be no retribution and so a reasonable caution need not be observed—at least when they are British.

There was a widespread custom to bury the founding member of a Clan within the new house, and thereafter offer sacrifices to the spirit of the Clan ancestor—the lars.⁽¹¹⁸⁾

And Samuel died, and all Israel gathered together and lamented, and they buried him in his house.⁽¹¹⁹⁾

The fact that this typical Stone Age village belongs to the Bronze Age epoch of further south is a remarkable conformation of Sir Norman Lockyer's dating of our stone circles, for he dated

the circle at Stinnes in Orkney to about 700 B.C. ; aligning it to the May-November year. It suggests folk who did not like the change to the solar year and other new conditions in the south, and so migrated to the far north.

On the fundamental principle of cleanliness and health New Stone Age conditions were clearly far in advance of anything to be found in Europe until the mid-Nineteenth Century. (It was not until the reign of Queen Victoria that the medical profession slowly overcame a vigorous opposition and reintroduced a sewage system.) In our fairy lore will be found dim memories of the Stone Age people. The fairies were regarded as ancestors. They—the fairies—were averse to iron. They were associated with standing stones, with old sacred wells and trees. Their circular dances were to promote the growth of crops. They were fond of white horses and were skilful at hunting. They originally disliked all clothing. Their neatness, cleanliness and love of washing were in striking contrast to mediaeval conditions. They presided over birth (Candlemass), and Hallow'en ; and they believed in reincarnation. They were also associated with buried treasure.⁽¹²⁰⁾ Probably all these were characteristic of Stone Age life ; their treasures being buried and lost when driven out by Bronze Invaders.

In Neolithic times the lake-pile dwellings were rectangular and thatched, but it seems that most houses were built on the same principles as the great stone monuments and were circular. It is probable that this form of house with its circular table for communal meals and entertainments gave rise to the later legends of King Arthur's Round Table.

The family, as we know it, consisting of father, mother and children, was then an unknown institution. We now regard this social unit not only as the hall-mark of civilization, but also as being the natural one ; but we think thus because we have never learnt to understand how, why and when the Curse of God drove us out of the Garden of Eden.

In the older social unit there was no marriage as we know it. At first marriage was simply an economic union between brother and sister⁽¹²¹⁾ ; later it was a union between the chieftain and the eldest woman. The king ruled solely by virtue of his marriage. When the woman died, either the king had to marry his own daughter or his daughter's husband became king.⁽¹²²⁾ In no case did these early marriages impose any sexual restrictions.⁽¹²³⁾ Later again when the chieftainship became hereditary the male heir was invariably the son of the chief's sister.⁽¹²⁴⁾ It was unlikely

in those days that anyone knew which man was the father of any child.

Before the rise of the patriarchal family it was considered a major social offence to punish a child. When some early missionaries advocated the use of the rod to correct a child they barely escaped from being torn to shreds by the collective fury of the women.⁽¹²⁵⁾ Since the human male reaches the peak of sexual capacity before puberty,⁽¹²⁶⁾ no girl reached puberty *virgo intacta*; they considered all girls virgin until they had their first child. The idea of reserving one woman for one man would never have occurred to them as either reasonable or possible.

These notions are not nearly so "primitive" as we are apt to think. We forget that in N.W. Europe for the first thousand years of Christianity it was almost universal that only a bastard could become a king or hero (see note 271). Celibacy was not even imposed on the Church until 1056 A.D. At the Council of Paris in 1074 all bishops, abbots and priests not only refused to obey the papal mandate imposing celibacy, saying it imposed "an intolerable burden," but they set upon the papal emissary, the holy St. Gauthin, and beat him almost to death.⁽¹²⁷⁾ The cardinal-legate sent to London to impose this edict was driven out of the country.⁽¹²⁸⁾ The abbot elect of St. Augustine's Canterbury boasted of seventeen bastards in one village alone and ridiculed chastity.⁽¹²⁹⁾

Dr. Lea fills two large volumes with authoritative stories of this type and says "instances like these could be multiplied almost indefinitely."⁽¹³⁰⁾ All this helps to explain exactly what Sir James Frazer meant when he wrote:—"Marriage was at first considered a grossly immoral infringement of communal rights."⁽¹³¹⁾

In the Stone Age there was a "Twentieth Century" equality between men and women, whereas under the church if a man tired of his wife he had a legal right to put a rope round her neck and so lead her to the cattle market and sell her to the highest bidder (tax was even charged on the price of the rope). A leading article in *The Times*, July 22nd, 1797, tells of Smithfield market being at that time famous for such sales.

Our own moral code is therefore largely a form of self-delusion to disguise the economic factor in marriage under the cloak of morality. The age of marriage has risen greatly in the last fifty years because people can no longer afford to marry young. In early Victorian days fourteen, and in Tudor times twelve, was common enough to marry off a girl. So far as the parents were concerned

it was simply a cash transaction. The prestige attached to pre-nuptial virginity has no moral basis because it originated solely in the higher price a virgin-bride would fetch, which in turn produced the taboo whereby a loss of virginity excluded a girl from the marriage market. It is possible that future generations will consider that to outlaw a child by dubbing it a bastard was one of the most evil forms of voodoo in all history. It was certainly no advance on societies which welcomed the little one as a divine gift of the Gods. In fact it turned a potential spiral of happiness into a vicious spiral of hate.

Moreover, there is also some reason to believe that societies in which there was no forbidden fruit were sexually quiescent ; so much so that they were only roused at the time of the festivals ; and that there was a placid harmony in their social relations almost beyond our comprehension, owing to the absence of jealousy among the men and of competition among the women.

We have need to know a great deal more about social conditions during the early agricultural epoch because there are indications that it began to develop as a peaceful and non-warlike community. It is obvious that we of the Twentieth Century have scant hope of survival as a civilization unless we can discover exactly what elements in a collective life lead respectively to either peace or war. The earliest agricultural settlers in Europe "never seem to have developed the warlike arts."⁽¹³²⁾ Their culture was destroyed by invaders armed to kill and against whom they had no defence.

In Central Brazil a similar type of community has survived until our own times without ever developing social violence. William Bölsche writes :—

The Bakairi Indians still live in the Stone Age, without any weapons. They go practically naked. They lack brutal cannibalistic traits. A gentleness pervades their social relationships And there is a sunny joyousness about their whole nature, and art, sparkling with ornament and colour ceilings and walls, straw mats and implements rise above the beautiful nakedness of their bodies in a veritable intoxication of art and applied arts. Festivals with dance and song extend through their lives like a chain of flowers. (133)

In Neolithic Britain there must have been long periods of peaceful conditions. The size of the great circles shows that they were built for large numbers who must have travelled long distances, leaving old people and children behind. The circles themselves were indefensible. Had they been the type of people to practise large scale human-sacrifice and bonfires they would have handed down to us harsh and cruel laws, not our love of justice and those

laws and customs which made us the modern centre of the democratic way of life. We also inherited from them our skill as craftsmen. They made axes "so perfectly true that no stone worker in the country could make them now ; and saws of flint with twenty-seven teeth to the inch, so that we must use a lens before the extraordinary skill of the worker is made manifest." They also had razors made of flint and obsidian.⁽¹³⁴⁾ Professor Gordon Childe says :—

Our debt to pre-literate barbarians is heavy. Every single cultivated plant of any importance had been discovered by some nameless barbarian society.⁽¹³⁵⁾

But the use of the word "barbarian" is misleading. Theirs was a culture with an evolutionary future ahead of it, ours on the contrary has a core of violent self-destruction and its future is black and grim.

Also archaeological writers of Stone Age Britain give an impression of harsh and drab conditions. But in the case of Maiden Castle they were conditions of war, comparable to our own lives in air-raid shelters. They give no idea of the earlier times of peace. Archaeology must from its very nature tend to exaggerate drabness because it attempts to build up a picture of the whole from a few scattered remains and tells us nothing whatever of love and laughter, and above all of the flowers which played so large a part in early life.

The Spring Festival must have been a time of great happiness, merriment and social harmony. It probably lasted for several days beginning with a cattle fair and sporting contests ; leading in some cases to the selection of the king and queen of the May. On May Eve there must have been much busy preparation, for it was a festival of flowers ; almost of flower-worship. The Sacred Tree was either the rowan, the mountain ash, or the hawthorn. Crosses had to be made of rowan wood which they wore on their heads, tied over the doors of their houses and to the tails of their cattle. Far into historical times the Stone Age origin of these crosses was indicated by the fact that they had to be made without the aid of any form of metal.

They also decorated their houses with honeysuckle (presumably the leaves) and the flowers of the mountain ash and may blossom. Cloaks of green leaves had to be made for some, if not all the men. Daisy and buttercup chains and garlands of flowers had to be woven. Those for the king and the queen of the May were all

blue which was the colour of virility⁽¹³⁶⁾ ; and those for the sacred phallus of the Great Mother were of violets.

Very early on May morn the girls went out to collect the dew drops from the may blossom. In this respect it is interesting to note that very recent investigations into homeopathic medicine state that dew drops have definite medicinal value, which varies according to the plant upon which it forms. In the half light of early dawn any one who was sick or injured was taken to the Great Mother whose home was near a Sacred Tree and a Holy Well. The sick were baptised or sprinkled with water from her well and pins were dropped into the water. Many saw visions and some would have been miraculously cured, precisely in the same manner as at the modern shrine of Lourdes, where these Stone Age customs are still active.

One of the functions of the Great Mother was to tend the central fire and to see that it never went out, except at the great festival. Hence she had to remain immobile and was dependent for her food on gifts from the community. It is thought that the new clothes once so essential for Easter were a survival of the custom of presenting fresh garments to the Great Mother by tying them on to her tree. As late as the Nineteenth Century in parts of Britain, in a vague memory of the old Festival, they still tied bits of rag to trees near a once holy well.

The most solemn ceremony of the morning took place at sunrise on the Sacred Mount, the Hill of Paradise. On the hill top was an altar, and a throne of stone, surrounded by a circle of stones or wooden posts. As the sky began to redden they would have gone forth chanting hymns to form a half-circle round the throne, facing the point of sunrise. The seeresses in long white robes led the Virgin Queen of the May into the half-circle of singers, there to decorate her with garters and garlands of blue flowers, and to hand to her the precious vessel containing the anointing oil.

Then as the rim of the sun gleamed on the distant horizon the King of Heaven came forth from the back, naked but for his great headdress of horns, to sit on the throne while the Queen went up solemnly to anoint him and place on him his garlands of violets. Doubtless for such a ceremony the Great Mother would have left her fire, or ceremoniously put it out. In many places it was probably she who played the rôle of the Heavenly Bride ; in others that of the chief of the seeresses who handed the clan battle-axe into the keeping of the Horned-God.

After the conclusion of the ceremony they would have formed into a procession leading in some cases a deer, in others a sacred white bull to be sacrificed on the Great Mother's altar, and so break their fast in a general feast. We know that they spent much of the day dancing in and out and round their houses collecting and picking flowers. There was also a circular dance round the Sacred Tree. In places where there had been continuous residence for centuries the tree decayed and was replaced by a huge wooden pole, a Tree of Life or May Pole. The round dance would have consisted of an outer circle of men and an inner one of girls, and while they danced the girls sang the age old song "Here we come gathering nuts in May. Who shall we have for our nuts to-day?"

In Roman days nuts were still sacred to Priapus and were scattered at weddings, as we scatter rice.⁽¹³⁷⁾ But the word nut itself was a colloquial expression which by historical times had lost its original meaning and so became a half-disguised substitute, for during the dance the girls chose their lovers by placing the hand on the sacred organs. The same gesture was the customary manner of swearing an oath (see note 349).

When evening came they would have formed into the main procession of the day to go up the hill again to light the Beltane Fire. From still existing customs and particularly from a remarkable description of the Midsummer Watch in the Sixteenth Century⁽¹³⁸⁾ it is not difficult to picture them, for much of the pageantry of the Midsummer Watch was symbolical and can be traced to a great antiquity; some of it transferred from the older May Day customs.

First came a company of archers wearing kilts of tartan, their bodies tattooed with the clan symbol, which one day was to become the nobleman's coat of arms. If they wore bonnets we can be sure that there was very little bonnet and a great deal of feather; and that the right to wear feathers would not have been easily won. To put a feather in one's cap must originally have been some sort of distinction. Each archer was accompanied by a young naked boy who carried his sheath of arrows and his cup of wood.

Then came a choir of singers and musicians with flutes of reeds, rams' horns, harps, and a simple type of bag-pipe; then a young man carrying the ceremonial axe immediately in front of the Horned God riding on an ass or shaggy pony. Behind him came men carrying the great garlanded phallus or Tree of Life. Then followed the seeresses in long white robes decorated with rowan

and apple blossom, and after them a company of men entirely clothed in cloaks of green leaves.

Next came four men carrying a litter decorated all over with may or hawthorn blossom on which was seated the Queen of the May in her blue robes and garlands of violets and lilies of the valley. Around her danced her maids, little girls naked but for their daisy chains, and behind her a large dragon of wickerwork to be ceremoniously slain by the Horned God in his rôle of the Great God Bal or Bel. Then came a great giant of wickerwork to be added to the bonfires. Guarding the giant came a group of men carrying spears, and then a young man bearing aloft the Phallus of the Great Mother, the clan Thunder stone, which was one day to become the mace of ceremony. Then came the Great Mother's brother, the old man of the town, wearing the same white robes as the seeresses and a garland of marsh-marigolds and buttercups which was in later times to become the great golden chain of office. Lastly, at the end of the procession came the dogs and all the sheep and cattle.

Some of the songs they sang were still current among the troubadours of Tenth Century Provence, but they have never been translated into English, for since the early times there has been a complete reversal. Words which to-day are so degraded that it is illegal to print them and outside the social pale to speak, were then so sacred that they were probably only used in the hymns and psalms of the festivals. Shakespeare, as Dr. Dowden has pointed out, was the last European writer to use the word cock for God.⁽¹³⁹⁾

The night of the Beltane fires must have been a time of such gaiety, happiness and excitement as we have not known for countless generations of toil and woe and war. As soon as the fire was blazing each one of them cast a stone with a personal mark on it into the flames. It was accounted very bad luck if they failed to find it again towards dawn when the embers were cooling. The fires were built in pairs with a passage way between them so that the live-stock and children could pass between them and be magically protected for the coming year.

Then they took off all their garlands and cloaks of leaves and burnt them as a form of purifying rite, and, like King Saul and the prophets of Israel, they were stripped and naked⁽¹⁴⁰⁾ and gathered around to watch with reverent awe the solemn ritual of the Sacred Wedding. The successful performance of this rite, so they believed,

would bring rain in the summer months and increase the fertility not only of the land but of the women and the animals.

We must remember that, as the *Cambridge Ancient History* tells us of identical festivals in Old Israel:—

Such were the ideas of the sympathy between people and land that the inveterate licentious cults themselves were not mere foul orgies, but meant a union with Deity : perhaps not without some effect upon the general fertility of all life and growth.⁽¹⁴¹⁾

After the Return from Captivity the prophet Zachariah thundered against the new religious prudery and declared that unless the old feasts were kept there would be no rain.⁽¹⁴²⁾ In Britain countless generations were to pass before that old serpent who deceived all the world⁽¹⁴³⁾ was to enter into this arcadian Eden.

The Feast of the Dead in the middle of November was very different in character, but the people do not seem to have been awed by their belief that the dead returned to their homes. On the contrary, they prepared a feast and laid an empty place for the returned shade. They decorated themselves and their homes with the scarlet berries of rowan, hawthorn and holly. It was essentially a feast of the setting sun and they prepared small model boats in which they put gifts for the dead. At dusk they lit lamps in the little boats and placed in them gifts for the dead and then sent them sailing down the rivers to the sea. Afterwards they lit great bonfires on the hills. Doubtless the modern Guy Fawkes was centuries ago a great giant of wickerwork. Whatever the basic conditions, their lives were filled with gay and cheerful festivals. It was not their life that was drab, it is ours. Our Christmas is now the last of the old festivals, just as it is the sole day in the year devoted to peace and good-will on earth which were once the essence of all the old feast days (see note 369).

CHAPTER 8.

THE GREAT SANCTUARY OF THE DOMINION.

ORTHODOX science consistently refuses to recognise the need for a serious investigation into astrology; even though long ago Dr. Franz Cumont said:—

Astrology is indispensable to the savant who desires to trace the toilsome progress of reason in the pursuit of truth.⁽¹⁴⁴⁾

For example, only those specialists in the Graeco-Roman period who have studied astrology have any real knowledge of classical mythology. Similarly to Egyptologists, unversed in astrology, the *Book of the Dead* is all but closed. Nor can anyone have the faintest idea of the meaning of the Book of Genesis who fails to grasp and understand its astrological background.

Nevertheless our Astronomer Royal from time to time gives tongue on the subject like a hyena who has been pinged by an air-gun. This is unfortunate, for there are some who fall into the error that a knowledge of astronomy implies a knowledge of astrology. In view of the tendency to exploit astrology for purely fortune-telling purposes genuine criticism is *sorely* needed, but that which is based on prejudice and not knowledge defeats its own ends.

Unfortunately a similar prejudice on the part of orthodox archæology prevents any organised investigation into the existing remains of the great Star Temple at Glastonbury. The question here is not whether or no we believe in astrology, but of learning what the ancients thought about it, and so of finding out how much of their astrological beliefs became incorporated into existing legends, and have since been wholly misunderstood.

For example, the name "Arthur" is one of the greatest names in British history, possibly the most glamorous name in all legend. From about 1200 A.D. until quite recently King Arthur was regarded as a specific individual who reigned over Britain during the Fifth Century A.D. The orthodox tendency today (1952) is to consider that Arthur had no historical background and was a literary invention similar to the Scarlet Pimpernel. Our principal source for the details of Arthur's life come from the admittedly brilliant works of Geoffrey of Monmouth (c.1100 A.D.).

T. D. Kendrick, Keeper of Antiquities in the British Museum says:—

The *Historia Regum Britanniae* may safely be regarded as in general a twelfth-century invention.⁽¹⁴⁵⁾

He also points out that :—

An outstanding difficulty, then and now, about the all-conquering hero, is that Gildas does not mention him.⁽¹⁴⁶⁾

thereby suggesting that Arthur was unknown to Gildas and a literary invention of Nennius in the Ninth Century, much elaborated by Geoffrey in the Twelfth Century.

T. D. Kendrick again writes :—

What we have to note now is that however much Geoffrey may have cheated, even if he were nothing more than a romantic novelist with an antiquarian taste, he was the author of the most significant book in the history of British antiquities.⁽¹⁴⁷⁾

Later the Keeper of Antiquities poses the question why did Geoffrey write that extraordinary book, but he does not give us a convincing answer because by calling him a "romantic novelist" he has attributed to Geoffrey a Twentieth-Century instead of an early mediæval cast of mind.

We tend to-day to believe in nothing unless we have actual material evidence. We therefore disregard our legends and place-names and overstress our earliest documents. We have long thought of such early writers as Gildas, Nennius, Bede and Geoffrey as painstaking, would-be historians who honestly believed much that is now clearly "fantastic" and "preposterous." But we should probably understand them better if we considered them in relation to other contemporary writers ; and if we remembered that they were Roman priests first and Englishmen second and lived in the days when the temporal power of the papacy was being built up.

While our pious monks were busy writing "histories" of Britain, others, equally pious, were just as active with their pens on the continent. The Bishop of Bristol (1919) writes of them that:—

To anyone unfamiliar with the building up of the Mediæval claims on the foundation of the temporal sovereignty (of the popes), it must appear almost incredible that such a forgery as the Edict of Donation should have been perpetrated. But it is a mere trifle to the document which at last forced Peppin, Charlemagne's father, to make the Donation, which Charlemagne was induced to ratify in 774 A.D.⁽¹⁴⁸⁾

Dean Inge has also pointed out that in the growth of the Roman Church

the arts and crafts of sacerdotalism have never been exploited with such pertinacity and ingenuity.⁽¹⁴⁹⁾

It is in this light that we must consider our own early historians ; not as "romantic novelists," but as writers who had the definite task of distorting all ancient beliefs which ran back to

pre-Christian times. At the same time the Church was beginning, but only beginning, in northern Europe to suppress all local customs that had pre-Christian tendencies and origins. The zeal of the ascetic fanatic knows no bounds of sanity, justice, truth or mercy.

In those days knowledge of the past was handed down generation after generation by means of songs and ballads, which were part of all festivities and social gatherings ; and also by tales told over the fire during the long, dark winter nights. May Day, Midsummer and other festivals were still being celebrated according to immemorial custom with scant adaptation to Christian asceticism and beliefs. Even on the Continent of Europe the Roman Church was not then powerful enough to make a direct attack on the old feasts because they were under the active patronage of nearly every great prince and lay-lord. The first attack was therefore directed against the singers, bards and minstrels. Many of the collections of ballads mentioned in the priestly denunciations have been completely annihilated. Nothing has come to us.⁽¹⁵⁰⁾ Once again, as Sir Gilbert Murray pointed out :—

The polemic literature of Christianity is loud and triumphant, the books of the Pagans have been destroyed.⁽¹⁵¹⁾

Moreover the minstrels were not only denied communion,⁽¹⁵²⁾ but even the right of burial.⁽¹⁵³⁾

In England the Church met a far more active opposition. Here the bards had long been honoured as the friends of kings. Alfred the Great then put them under the protection of the Crown by creating in 886 A.D. the first professorship of music in European history.⁽¹⁵⁴⁾

The Church, however, did permit songs on purely historical subjects provided that they were suitably adapted, and that all the age old improprieties were censored out. Hence the Arthurian legends began to undergo a process of Christianising and puritanical censorship. By "the arts and crafts of sacerdotalism," the universal glamour and romance attached to the name "Arthur" was divorced from its true origin ; and there emerged a new Arthur, a pseudo-historical hero-king. The monks failed utterly to discredit the great honour and respect in which the British held Arthur, in his ancient form of God-King, and so they turned him into a chaste and goodly knight suitably encased in armour.

It is easy to trace how the traditions of our Royal House were adapted to Roman Catholicism to the glorification of Rome and the detriment of Britain. As the power of the Church increased after the Norman Invasion the great British Order of the Knights

of the Holy Grail was suppressed. The honour and respect in which this Order was held, not only in Britain but throughout Europe, was naturally damaging to the Roman cause because it pointed to a Church older than that of Rome.

But the Order of the Holy Grail itself arose after the Roman Invasion and before the coming of the first Roman Catholic missionaries under St. Augustine. It clearly replaced the far older Order of the Round Table, whose origins were Pagan and pre-Roman. In the Ninth Century the Swan Knight of the Holy Grail escorted the grand-daughter of Alfred the Great to Cologne for her marriage to the Emperor Otto. In the German mediæval legends the Swan Knight is mentioned as coming as an envoy from the Court of King Arthur;⁽¹⁵⁵⁾ a suggestion that no matter who was the head of either of these ancient Orders, he always bore the ceremonial title "Arthur."

In modern Freemasonry the apron of ceremony worn by the Grand Master symbolically associates him with the Sun. In pre-Christian days the head of the Order of the Round Table would undoubtedly, on certain ceremonial occasions, have appeared as the impersonation of the Sun or the Sun-god.

By the time of Geoffrey of Monmouth, the connection between Arthur and the ritual of the ancient Orders would have been forgotten, and it was thus safe to bring him forward as a specific individual and to write of his impossible conquests and battles as if they were established fact. It flattered the foolish English and no longer injured the Church. But Nennius in the Ninth Century had to conform to much older ideas and so—perhaps by accident—he gives us a broad hint as to the true nature of "Arthur" when he wrote that "Arthur fought twelve battles neither more nor less, one for each month of the year."⁽¹⁵⁶⁾ This makes it clear that we shall never recover the full meaning of our great Arthurian legends until we begin to understand the astrological beliefs of our ancestors.

There are many other hints of Arthur's astrological background: for example his father was the dragon Uther, his sister the Goddess Anu (Virgo); and his wife, the "White Lady," was the Moon.⁽¹⁵⁷⁾ Arthur's death had exactly the same mystical significance as that of the Christ. Arthur also descended to the antipodes for three days and three nights.⁽¹⁵⁸⁾ One of the chief features of popular belief concerning Arthur was his expected resurrection, "which was a more sacred thing to the men of

Cornwall and Devon than Church, monks and miracles.”⁽¹⁵⁹⁾ This, needless to say, was another reason why the Roman Church found it so essential to disguise the true meaning of Arthur by fraudulently converting him into a Fifth Century romantic king.

The extreme antiquity of the origin of the Arthurian legends is clear from the fact that the social structure of Arthurian society was matriarchal. Arthur rules over the kingdom of Avalon solely by virtue of his marriage with the pagan queen Guinivere, who is the real owner of the kingdom.⁽¹⁶⁰⁾ The attempted seductions of the queen, which continue even in the most Christianised forms, originally indicated attempts—like that of Absalom—to obtain the kingdom by eloping with the royal woman.

We do not know the name of the king of Britain at the time of the Roman invasion. Latin writers called him Caractacus, but also Arviragus. The former was a title assumed only in war, meaning king-commander. The latter was the Latinised form of *Ard an rhaig* meaning king-paramount. Latin was the language of our early writers so the names have mostly come down in a Latinised form with the suffix—us. Thus in Latin we find the name Britannicus. Arvira-gus would seem to be the best the Romans could make of the Celtic title. But Cockneys still say “v” for “th,” and so Arthira-gus would appear to be the origin of the name Arthur. In this case Arthur is the Anglicised form of the Latin for the title “king-paramount”; he who was also the God-King. This would account for the reason why the name Arthur became associated not only with the legends and historical exploits of many kings, but also with mythological beliefs. It also explains the fantastic number of feats attributed by mediæval monks to one specific individual; an individual probably created by the monks with intention to deceive, i.e., to Christianise. In spite of this, and in spite of the modern scholastic attempt to ridicule the whole story of Arthur, the name remains immortal.

The kingdom of Avalon is known to have been the pre-Christian name for Glastonbury. A. E. Maltwood has recently published a series of aerial photographs showing that a gigantic zodiac was carved out of the earth near Glastonbury. This zodiac, covering some sixty-four square miles, was probably the greatest wonder of the Ancient World. The great “finger” lying on the equinocial line indicates a date about 2700 B.C.

Under the disasters of the Roman, Saxon and Danish invasions the meaning of the giant zodiac was lost and its very site became unknown; but as A. E. Maltwood writes:—

Is it any wonder that such a Cauldron of Wisdom was the object of the "Quest" : that it was known before the twelfth century as the Enchantments of Britain, the Wonder of Great Britain, and the Great Adventure of the Kingdom of Logres. (161)

It is obvious that something very important had been lost, something which gave rise to the legends of the Quest for the Cauldron of Wisdom, which were later Christianised as the Quest of the Lost Cup of the Holy Grail. But even in the late stories of the Grail all knowledge of the original nature of the Round Table was not entirely forgotten. In a translation of *La Quest del Saint Graal* we read:—

By its name the Round Table is meant to signify the round world and the round canopy of the planets and the elements in the firmament, where are to be seen stars and many other things After the Table there is another like it, that was the Table of the Holy Grail which gave rise to so many and great marvels in the country. Now, fair sir, in the meadows which you saw there was a rack. By this rack we must understand the Round Table for just as in the rack there are spindles which separate the compartments so in the Round Table, there are pillars which separate the seats. (162)

Commenting on the above A. E. Maltwood says :—

This exactly describes the Solar Wheel. As one hundred and fifty bulls were feeding at the rack as well as four thousand people it must have been no ordinary table, but we are told it was "in a meadow." The Round Table of the Sun in Somerset measures ten miles in diameter, and consequently was well able to provide food for 150 bulls and 4,000 people. (163)

The existence of this giant zodiac does not commend itself to orthodox minds. The work of A. E. Maltwood has not received the scathing criticisms that were once launched at the work of Lewis Spence, instead it is met with a shrug of the shoulders and a gentle tapping of the forehead. It is, however, an interesting example of the need for national deep-analysis. When a sick man is under psychological treatment he will quietly recall many memories of childhood ; but in skilful hands, after long treatment, there comes a time when the festering forgotten memory comes near the surface ; at that moment there is nearly always a sharp reaction and the patient puts up a violent resistance. This symptom is clearly marked in the national mind by the extraordinary reaction of orthodoxy to new facts about our lost history. They are never welcomed but always refuted with virulence and often animosity.

It is certain that there was some sacred place in Britain which the Greeks regarded as different from and quite as remarkable as Stonehenge. Diodorus Siculus (c. 60 B.C.) quoting from lost manuscripts said :—

Amongst the writers who have occupied themselves with mythology of the ancients, Hecatæus (c. 400 B.C.) and some others

THE GREAT SANCTUARY OF THE DOMINION

tell us that opposite the land of the Celts there exists an island not smaller than Sicily the inhabitants worship Apollo (the Sun) more than any other deity. A sacred enclosure is dedicated to him (the Sun) in the island *as well* as a magnificent circular temple they are in general friendly to the Greeks. (164)

He also says the "Sons of Helios" (The Sun) are distinguished from others by their education and knowledge of astrology. (165)

A sacred enclosure which the Greeks linked in fame with Stonehenge must have been some outstanding feature of the country. In our lost history it was said that before the coming of the Trojans Britain was called Albion and was a land of giants. This has been used as a weapon to ridicule our history. No skeletons of giants have ever been found; so, runs the argument, it is just the merest fable. And that in spite of the fact that the giants are still with us:—The Cerne giant of the Dorset Downs, the Wilmington giant, the Dragon of Uffington and until the end of the Sixteenth Century Gog and Magog at Plymouth. (166) Doubtless in earlier days there were others, for only by a miracle have these not vanished beneath the turf. Obviously strangers coming to this island and seeing these huge white figures carved on the mountains would have spoken of it as a land of giants. The lost history clearly hints that the Giants were pre-Trojan, and belong to the early May-November year. Bel was himself in some legends known as a giant.

Also people who carved such figures were quite capable of designing a zodiac in a similar manner, and it is indisputable that astrology formed the core of the ancient religion.

Ceremonies having astrological significance were part of the ritual of Ancient Britain. In Wales, where the old customs lasted longest, such ceremonies were always associated with Druidism. Cynddelw, the Bard, sang of the mystic lore of the Druids:—

Rapidly moving in the course of the sky, in circles, in uneven numbers, Druids and Bards unite, in celebrating the leader. (167)

The most famous of the Bards, Talisien the Radiant Fronted (c. 400 A.D.) sang:—

I have presided over the circle of Sidin—the circle of the Zodiac—whilst that is continually revolving between three elements.

Is it not a wonder to the world that men are not enlightened. (168)

E. Davies, who specialised in the Welsh records, wrote:—

Hence we may fairly conclude that in those ages the temples which were sacred to British mysteries were regarded as images of *Caer Sidi*, or the Zodiac, as they were dignified with the name, or else were so constructed as to represent some of the phenomena displayed in that celestial zone. (169)

The poet Aneurin wrote, about 473 A.D.:—

In the presence of the blessed one, before the great assembly, in honour of the mighty king (Hu) of the plains, the circular revolution was performed by the attendants, and the white bands in graceful extravagance. The assembled train were dancing, after their manner, and singing in cadence, with garlands on their brows: loud was the chattering of shields, round the Ancient Cauldron, in frantic mirth (170)

In England the old religious rites very early lost official support from the Crown and, where they survived, changed into local mummers plays, pantomimes and games. At Dorking, in Surrey, the traditional ball game was held once a year on Shrove Tuesday. H. J. Massingham tells us that:—

The game was not a sport but a religious service The game was played by people with a social organization which was split into two halves for ritual purposes. One side of the community representing the sky-world and its solar cult, and the other the underworld The costumes of some of the players represented the ancient king-gods of Britain. (171)

In the North Somerset Mummers' play one of the actors personified the "Prince of Paradise." (172) In broad outline the Dorking game must have had exactly the same significance as the great Midsummer Pageant when Michael, as the Sun, fought the Dragon of Darkness.

The chief festival of the year was May-Day. Cormac, arch-bishop of Cashel, wrote in the Tenth Century that

in his time four great fires were lighted up on the four great festivals of the Druids, viz: in February, May, August and November. (173)

Sir Norman Lockyer says:—

Mr. Griffith has rendered another service to archæology in its widest sense by pointing out the enormous number of Welsh and English fairs held on festival (quarter) days of the May year. These, doubtless, are the modern representations of the assemblies at the festivals of the places where circles existed, or where fires were lighted or Gorseddus erected; so that it may be said that fairs as well as many old churches mark for us the loci of the original circle-worship, and the fact that we are dealing with the May Year and not the solstice shows that we have to do with a very high antiquity. (174)

There was a time when these ancient festivals were carried out with all the splendid pomp and ceremony of a Twentieth Century coronation or royal wedding, except that in the old days they were less of a spectacle with the people looking on and more of a national festivity with everyone taking part. Then, under the influence of invading armies and Roman missionaries, the royal patronage was withdrawn. Country folk kept up the ceremonies, but they gradually lost their significance and became rustic in character.

They ceased to mark national occasions and except for certain local survivals mostly died out.

The Chester Dragon was not destroyed until Cromwellian times,⁽¹⁷⁵⁾ and another, probably the last, survived in Oxfordshire until living memory.⁽¹⁷⁶⁾ But a thousand years earlier Michael ceased to be the Great Patron of Britain and thus there came a time when there was no longer a Michael to fight the dragon on Midsummer Day. It was then, and not till then, that the Dragon was free to enter into the Garden of Eden and persuade the British to become ashamed of their age-old religious nudity, and so brought down on our heads also "the Curse of God." It was not until then that a potential spiral of happiness was turned into an actual spiral of destructive activity whose ever increasing crescendo of violence now threatens us with destruction.

A thousand years ago folk in Britain believed that the Garden of Eden—like Paradise Hill at Glastonbury or Old Paradise in London—was the name of the sacred place where they met together for their ancient festivals, and consequently Paradise Lost had a very different meaning to them from what it has come to mean to us. In the Fourth Century, whether A.D. or B.C., people said Paradise is here in Britain—we know because we've been there. During the Eighteenth and Nineteenth Centuries, with equal conviction, we said it was somewhere in Mesopotamia. Now in the Twentieth, we are beginning to regard the Mesopotamia idea as a pious platitude for quiet Sundays and to declare that it is really a mythical conception without a trace of any historical background, and so of no practical application to everyday affairs.

In a somewhat similar manner the Greeks had legends of a Lost Golden Age which is also considered to be purely mythological and imaginative. But it would seem that myths and legends, as well as fairy tales, are never mere products of human imagination, but invariably historical facts embroidered and distorted by imagination and by hostile propaganda.

In the Greek legends Cronos was said to have been the ruler of the Golden Age, and to have been deposed by his son Zeus and then sent bound in chains to Britain.⁽¹⁷⁷⁾ Plutarch recording the legend says :—

Moreover there is, they say, an Island in which Cronos is imprisoned, with Briareus (a giant) keeping guard over him as he sleeps; for, as they put it, sleep is the bond forged for Cronos, and that around him are many divinities, his henchmen and attendants.⁽¹⁷⁸⁾

Sir James Frazer⁽¹⁷⁹⁾ pointed out that the Greeks recognised that Cronos was identical with the Phoenician-Semitic God El or Al—the El Elohim, or God of Gods of the early part of the Old Testament ; and consequently identical also with the British Bel, Bal, Balan or Alan.

It is clear enough that these myths have an historical background. In the evolution of man's idea of deity there was first of all his conception of the Great Mother. With the growth of agriculture there was a slow change from matriarchal to patriarchal forms of social order. This change was marked by the rise of the first male deity, the benevolent Father-God, whose interests were identical with those of his people.⁽¹⁸⁰⁾

This was a natural conception for the god was then local, not universal ; human, not spiritual. He was the Bridegroom in the Kingdom of Heaven, the son and lover of the Great Mother. He was the tribal patriarch or king who presided as god over the yearly festivals. Hence he was a god of the living and not of the dead, and his heaven was of the earth earthy and not the abode of the souls of the dead. In India he was Indra ; in Greece, Cronos ; in Rome, Saturn ; in Egypt, Set ;⁽¹⁸¹⁾ in Phoenicia, El ; in Britain, Balan ; and to the early Hebrews, Yahweh, who was at first in all respects identical with Baal.⁽¹⁸²⁾

The next phase in social evolution was the rise of the first kingdoms of some extent. As they grew in size, through conquest, the god-king was no longer personally known to everybody. He became a remote personage whom many never saw all their lives. By the time of the rise of the great Persian Empire, for the majority he was invisible, remote and so gradually became spiritualised. His interests ceased to be identical with those of the people. He ruled by terror, force and slavery and his people came to regard him with fear and to placate him with bribery, sacrifice and prayers of supplication.

This great social change was reflected in all mythologies by the stories of the overthrow of the ruler of the Golden Age. Indra was sent from India in chains and disgrace ; Zeus replaced Cronos who was sent in chains to Britain ; Jupiter replaced Saturn. Amen-Ra—the hidden sun⁽¹⁸³⁾ became the dominant divinity in Egypt, replacing Ra—the Sun, and in Palestine Baal-Yehweh became the Jehovah of the Jews. Only in Britain was there no such change.

In broad outline these mythological stories reflected the overthrow of the Bronze Age by the Iron. In many places man

achieved very considerable heights in art and culture during the Bronze Age and almost everywhere when the end came it took the form of a sudden and complete collapse. The Fall of Troy, the Fall of Knossos, the Fall of Jericho, the disappearance of Israel, the collapse of Mycean Greece and later the sack of Carthage were all part of the same general pattern.

Most of these folk were seafaring people or had neighbours who were. Some had reached Britain before 2000 B.C., and there is reason to believe that in every case some refugees from disaster fled westwards and reached Britain. Thus arose the Greek belief that Britain was "The Sanctuary of Cronos." In this respect we must remember that in old British Law "There are three persons who have a right to public maintenance : the old, the babe, the foreigner who cannot speak the British tongue."⁽¹⁸⁴⁾

The right of Sanctuary was law in England down to the reign of Henry VIII. In remote times Avebury Circle was known as "The Great Sanctuary of Dominion."⁽¹⁸⁵⁾ To this day the open space fronting the West Doors of Westminster Abbey is known as the "Broad Sanctuary." Fechan, the last of the Abbots, pleaded in vain to Henry VIII for its retention, saying that the Abbey had been a sanctuary ever since King Lucius built the first church in the Second Century.⁽¹⁸⁶⁾ The great doorknocker at Durham is another relic of the ancient right of sanctuary.

But although we no longer grant right of sanctuary to fugitives from the Law we still maintain—even in time of war and despite the danger of admitting spies and enemy agents—the right of sanctuary to fugitives from the great tyrannies of Twentieth Century Europe.

We may safely number amongst the earliest refugees to reach Britain those agricultural peasants who fled before the eruption of the Battle-Axe people from Russia about 2500 B.C. Many of the survivors of the Battle-Axe Invasion remained as peasants working for their conquerors. It was only those to whom personal freedom was a burning conviction who would have taken the great risks of going westwards into the unknown.

There is an obvious probability that men of such a type would have fled to Britain, during the collapse of the Bronze Age, from Mycean Greece, Crete, Troy and Phoenicia. It is perfectly feasible that Jeremiah and the princesses of the House of David having fled from Jerusalem to Egypt should have fled, as legend says, from

Egypt to Britain, when Egypt was also invaded. Palm trees on some early British coins suggest refugees from Carthage.

The scoffing scepticism with which it is now fashionable to doubt the legend of the coming of Joseph of Arimethea to Glastonbury is not justified by the possibilities and even probabilities. Britain was the only free country in the world at the time of the persecution of the Christians which caused the martyrdom of Stephen. There is no more evidence for that persecution than there is for the story of Joseph. Yet the British legend is rejected by critics who would not dare to attack the other.

During the long Dark Ages under the tyrannies, violence and bloodshed of the Romans, Saxons, Danes and Normans it was Ireland which maintained the right of sanctuary and, in consequence, became the sole great centre of learning in Christendom during the early Middle Ages.

After the Reformation the ancient right of sanctuary was instinctively revived. Humble Huguenots and Flemish folk found refuge with us from Catholic persecution. Later came Louis XVIII and the Catholic aristocrats of France. In our own time the Queen of Holland, the Emperor of Abyssinia, the kings of Portugal, Rumania, Jugo-Slavia, Greece, Norway and Siam and many craftsmen and scholars from the Nazis and Soviets must one and all, on placing the first foot on British soil, have felt the same thrilling sense of relief as did the men who succeeded in reaching the great doorknocker at Durham, or the West Door at Westminster; or in far earlier times when they passed into the Sacred Circles and so under the protection of the Ancient Britons.

CHAPTER 9.

MICHAEL'S MOUNT.

A RECENT clerical authority writing of Michael says :—

Given the ancient dedication to Michael and a site associated with a headland, hill-top, or spring and it is reasonable to look for a pre-Christian Sanctuary—a pre-historic centre of religious worship. (187)

In all these cases Michael, the great God of Midsummer and Harvest, was Christianised without change of name. This was a custom common enough in early church history. The Rev. S. Baring-Gould writes in *The Lives of the Saints* that:—

The traditional " Acts of St. George " are simply an adaptation of the heathen myth of a Solar God to a Christian saint.

Dr. M. Hamilton points out that there is a whole class of Christian saints who,

in their history and attributes suggest distinct reminiscences of ancient heroes Legend and biographical incidents, attributes, and deeds belonging to Pagan literature, and associated with the great names of tradition, appear anew in the *Acta Sanctorum* with little disguise except change of address. (188)

Some of the more astounding direct changes are Saint Satyrus and Companions, St. Elias, St. Venere, St. Dionysus, St. Bacchus and Companions, St. Hermes, St. Posidonis, St. Saturn, St. Blaise, St. Bridget the Bride of Kildare, St. Belinda, St. Bellinus, St. Anu, St. Allen and Companions and St. Ammon of Alexandria. (189) Even Old Nick, as we have seen, became St. Nicholas complete with his reindeer horns. Therefore it is not to be wondered at that the great British Gods Michael and George should now appear in their strange modern guise of saints. But Michael—particularly in connection with the Sacred Mounts—almost invariably replaced the still more ancient Balan.

One of his more important shrines is Paradise Hill, near Glastonbury, once the dominating hill of the Insula-av Allon, and now capped by a tower of St. Michael. As in London so in Somerset; there are many traces of very ancient three-letter place names. West of Glastonbury near the sea is Hol-ford Cross, and Ful-ford. Nearer there is a Holy Well between Pol and Eden (Polden and Edington). North-west, Staughton Cross is near Al-stone and Stone Allerton. Within the giant zodiac is Bal-ton ;

and the "meadow of the Tents" is between Wal-moor and Wal-ton. East, on the way to Stonehenge, is Bal-comb, and south-east is Al-ford and the river Al-ham, and the Dancing Cross at Hol-ton. On the road to the Cerne Giant, about fifteen miles away, is Pul-ham. The Red Post Cross south-west of Glastonbury, reminds one of Red Cross on Herne Hill in London.

It is clear that, as in London, these place-names go back to a remote past when the Great Mother was dominant. Mary Magdalene's Chapel at Glastonbury once belonged to St. Bridget and the fields nearby are still called "Bride's." Far to the south on the English Channel is Bride's Port (Bridport) and to the north-west Bride's Water (Bridgwater Bay), while across the Channel is St. Bride in Monmouth, St. Bride's Major in Glamorgan, and St. Bride's Bay in Pembroke; north of which is Bride's Bay and Ann's Head. The two names for the Great Mother occur again at Queen's Camel, just south of the giant zodiac where Stockwell Cross lies behind Bridgehampton and Annis Hill. Camel was also an alternative name for Alan: Arthur having been killed at the ford of the river Camel or Alan.⁽¹⁹⁰⁾

An archæologist who sets out to examine the ruins of an old city usually finds deposits and foundations piled up one on top of another. Each layer that he removes brings him to an older layer. A complex language like English has certain analogies. If we remove all words of Norman-French and Danish origins we find the next earliest layer consists of Saxon and the next Latin. We have little idea what language they spoke in western England before the Roman invasion. It is a somewhat arbitrary assumption that these invasions drove the entire Gaelic speaking population to the far west. The place-names of London and Somerset point to an older language than Gaelic.

Bride or Bridget, as the name of the Great Mother and of the great clan which founded Yorkshire, has affinities with Central Europe (see note 104). It does not appear to be as old as the name An. Both the Al and the An seem to be the oldest names we can trace, and both have affinities with an ancient language layer in the Near East. In an ancient Sumerian Triad we find the three names: Anu—El—Ea.⁽¹⁹¹⁾ Ea or Ia was eventually Christianised as St. Allen (October 27th) and was said to be the father of Michael, the Divine Twin, and messenger of Ea.⁽¹⁹²⁾ About the Second millenium B.C., in Palestine, the Goddess Anat was the patron of Baal and his son Alyen.⁽¹⁹³⁾

In Chamber's *Twentieth Century Dictionary* we read, under the word "Beltane" :—

An ancient Celtic heathen festival—usually explained as "Beal's Fire." *Beal* being a supposed Celtic deity who has been courageously identified with the Baal or Bel of the Phoenicians and other Semitic peoples, and Gael; *teine*. But even the last is doubtful.

While on the one hand we owe a great debt to all those scholars whose scientific attitude has ended much superstition and loose thinking, on the other we cannot but regret the gold they swept away with the dross and the growing tendency of extreme caution. Such caution savours too much of fear. A bureaucracy which has become characterised by excessive timidity can be as great a danger to a state as an armed foe. An overcautious science slows up the flow of progress. Fearlessness, even recklessness, is the hallmark of the pioneer. All too often it has been the man who fell by the wayside pierced by the arrows of his co-workers, who proved to be the leader of future advance.

If there are real difficulties other than those arising from fear in establishing the connection between the British Bael and the Semitic Baal, there are none in demonstrating the widespread character of the ancient Alan or Allon.

Vowels are, of course, one of the great difficulties. Many old scripts had no vowels; those in the Hebrew of the Old Testament were not inserted until about the Ninth Century A.D.!(194) In every language dialects largely consist of broad vowel differences. In our own days we are so used to fixed vowels that we should not understand what was meant if a writer changed the vowels in a word like London. Even in Shakespeare's time spelling was much more uncertain, and he would have driven a modern bank manager crazy. Therefore in primitive times there may be found considerable vowel differences without change of basic meaning. Thus we find B-L, and L-N with almost every possible variation (see note 31).

In this case there are not only many variations of spelling, but the same word is found to have an extraordinary number of apparently unconnected meanings. It occurs in the Old Testament as Allon, an oak.(195) The oak of the pillar.(196) The augur's oak or oracle,(197) which is identical with the "sanctuary of the Lord" where Joshua "set up a great stone under the oak,"(198) and also with the Elyon or Most High.(199) El Elion or God Most High is the same as El Elohim, the God of Gods,(200) who in the early days was the "chief of the dancers" (see note 28).

It was probably not until post-Babylonian Captivity times that the El or Al of the Oak and the Mount came to be regarded in the modern spiritual sense. In the early eras in accordance with world-evolution he was a local Man-God, i.e. the prophet, or man of God, who sat under the oak.⁽²⁰¹⁾ It was the function of the Man-God of the Oak to prophesy, to make rain⁽²⁰²⁾ to find lost animals,⁽²⁰³⁾ and also to increase the population; as in the cases of the barren Sarah,⁽²⁰⁴⁾ and the wife of Manoaah.⁽²⁰⁵⁾

As Sir James Frazer tells us:—

The prayer of Hannah is a familiar example of this practice. Multitudes of men and women, in fact, whose mothers resorted to holy men in order to procure offspring would be regarded as the actual children of the God, and would be named accordingly. Hence Hannah called her infant Samuel which means "Name of God." Probably she sincerely believed that the child was actually begotten in her womb by the Deity.⁽²⁰⁶⁾

As we have seen above (notes 64 and 74) the men of Sparta, the nobles of Etrusca and the mother of Augustus Caesar all held exactly similar ideas.

Hannah was doubtless one of the maidens who "danced the yearly dance of the vineyards⁽²⁰⁷⁾ at the shrine of the God El (Eli), in the "Mount of Beth-El"⁽²⁰⁸⁾ where "the glory of the Lord was like a devouring fire on the top of the Mount."⁽²⁰⁹⁾ El = Sun.⁽²¹⁰⁾ It is also to be noticed that Mount Heres, another name for the Sun, was in Aji-Alon.⁽²¹¹⁾ Thus in the Old Testament the ancient Alan is found in connection with the oak as the place of oracle, with the Mount, with the Sun, and with a fertility significance.

Similarly all these characteristics repeat in Ancient Britain in connection with the Mounts which became Michael Mounts. G. Riley Smith tells us that on an island off the coast of Sligo there was a phallic monument, consisting of an erect pillar surrounded by a stone wall, which was held sacred until the Nineteenth Century.⁽²¹²⁾ Another phallic stone in County Cork was called "St. Olan's Stone."⁽²¹³⁾ The most famous in Ireland stood on the Hill of Tara. This one came from a place called Bel-Pear which Kean believed was identical with the Baal-Prior of the Scriptures and like Priapus was the emblem of the Sun as the source of generative powers.⁽²¹⁴⁾

In Devon near Bel-stone and Bal Tor was an ancient shrine to Michael.⁽²¹⁵⁾ In Cornwall is the famous Hel Stone which is still associated with a ritual dance—the furry dance. Another is the great Hele Stone, or pointer, at Stonehenge, known as Friar's Heel. This is an interesting example of the widespread ecclesiastical use

of the euphemisms of the Old Testament. They were first used by the priestly censor, who, under the pseudonym of Ezra, substituted for the direct speech of the original Messianic Scriptures such words as feet, heel, thigh, side, horn, vine, etc.⁽²¹⁶⁾ (see notes 311 and 349).

The Roman Church frequently used the same euphemism when changing pagan temples into Christian shrines. In Italy, the phallus of the Heavenly Twins became the "Big Toe" of St. Cosmos.⁽²¹⁷⁾ Dr. R. Briffault gives several examples from mediæval France. The most remarkable was the canonisation of Priapus himself as St. Foutin, and the changing of the local lingam into a "holy relic," the toe of that saintly bishop.⁽²¹⁸⁾ This is a clue to the meaning of the great Friar's Heel at Stonehenge.

The Holy Oak—the Hebrew Allon—was also an important feature of British religious life, and the old name recurs in "vallonia" for the corn-cup, from the Greek *balanos*, an oak. The Sacred Tree is considered to be "love-provoking"⁽²¹⁹⁾; and in India to bestow children^(219a); so in Britain to enkindle to passion was *on alen* (see note 81). In Old French we find the same mystic connection in the verb *être en alain*, meaning to be in a "state of grace" when the male organ is *balane*. Rabelais also used the verb *beliner*; and *vallon* as the female *balane*.⁽²²⁰⁾

The name also occurs as an alternative for Bel's Mounts, as the Be-Alan of the Dinsul (so spelt in Toland's *History of the Druids*). Another connection will be found in the Babylonian word *allanu* for an oak, and *illanu* for an entrance or doorway.⁽²²¹⁾ The latter which is associated with Michael, is defined as "The Door of the Place of Calling," or "Door of Heaven."⁽²²²⁾ Colloquial survivals appear in the obsolete English word *hallan* used in connection with the hall of a house,⁽²²³⁾ in the French *salon*, where the best people meet, and the English *saloon*, a place of gathering for entertainment.

The Babylonian word *illanu* is also defined as "The Hittite,"⁽²²⁴⁾ and in this respect is associated with the Divine Twin. In the Hebrew version of the Twin Legend Esau was the Divine Twin (see note 269). After he had been driven out by Jacob he married the daughter of Elon the Hittite.⁽²²⁵⁾ Homer names an auger "Dolon the Trojan,"⁽²²⁶⁾ and we find an Irish Druid called Dalan.⁽²²⁷⁾

Bacons were lit on the Bel Mount for the Beltane on May Eve, "in honour of Beal or Be Alan, Latinised as Belinus."⁽²²⁸⁾

Camden (c. 1590 A.D.) called St. Michael's Mount the *Dinsol Olin*,⁽²²⁹⁾ and St. Caradoc the *Dinsul*⁽²³⁰⁾ which Borlass in his *Glossary* describes as "a sunny place dedicated to the Sun." The Beacons themselves were called the Fire of God, or dealan-de.⁽²³¹⁾ The fire dance at Allendale in Northumberland on New Year's Eve is one of the last survivals of the days when again "the glory of the Lord was like a devouring fire on the top of the mount."⁽²³²⁾ The solar meaning of Alan survived in Middle English as a word meaning "light," or one who gave light as a prophet.⁽²³³⁾ In mystic symbolism Alan occurs as the astral light, or Primordial Principle guarding the Tree of Life; and, as such, was symbolised as an eagle-headed lion, or griffin, slaying a dragon.⁽²³⁴⁾

In the *Greater Oxford Dictionary* Alan is defined as meaning a wolfhound, and this in mystic symbolism also stands for a prophet. In Early Egypt the dog-headed god Anubis was "a healer, prophet and messenger of the Gods, but "also a wolfhound,"⁽²³⁵⁾ who slew a dragon;⁽²³⁶⁾ and was a prototype of the Greek Hermes.⁽²³⁷⁾

In Egypt the rising of Sirius, the Dog Star, heralded the yearly flooding of the Nile. Hence in mythology the Dog Star was the announcer. Since the first-born, they, who had no fathers, were the Sons of God, so in Britain we find that in the Talisman of Cuno-Belin the Dog Star was the first-born Son of Heaven;⁽²³⁸⁾ just as in Asia Minor Michael was called the first-born son of the God Ia.⁽²³⁹⁾

What the ancients meant by dog in its symbolic sense we learn from the Greeks. Diogenes said he wanted to live the life of a dog because:—

The watch-dog of Zeus on earth had to fulfill his special duty, to warn mankind of the Truth and set slaves free. Nothing else mattered.⁽²⁴⁰⁾

C. W. King tells us that:—

The dog represents the Sacred Scribe and in another sense is a prophet.⁽²⁴¹⁾

The Greeks did not call Hermes "dog" as a proper name but on account of the watching and waking of that animal, and his ability to distinguish friend from foe.⁽²⁴²⁾

In course of time the sacred dog was, like Old Hornie, turned into his opposite so that the expression "to go to the dogs" no longer means to go to the prophets but to the bad. This typifies not only the triumph of the ascetic Jew over the sensual Greek, but also the little understood triumph of Judah over Israel.

In part of the Book of Exodus belonging to the priest's code of about 350 B.C. we read :—

The Lord spake unto Moses saying " Sanctify unto me all the first-born whoever openeth the womb amongst the children of Israel, both of man and of beasts. It is mine everything that is male."⁽²⁴³⁾

Then later came the law which said :—

I have taken the Levites from among the children of Israel instead of all the first-born that openeth the womb.⁽²⁴⁴⁾

Although this second law, like the first, was put into the mouth of Moses, at least a thousand years of social evolution separate the one from the other. The first is the law of ancient Israel, the second that of post-Babylonian Judah. " The first-born that openeth the womb " were those who had no known father and so were believed to be divinely born. They were the Sons of God who " personified the Goddess on the Sacred Mount,"⁽²⁴⁵⁾ and who walked " naked and barefoot like my servant Isaiah."⁽²⁴⁶⁾ They were the " holy ones"—K.D.SH(Kodesh)—and belong to the earlier strata of social evolution. It was not until the priests of Judah had usurped the functions of the prophets of Israel that they came to be denounced as dogs and sodomites—K.D.SH(Kadesh)—merely by the subtle play of the missing vowels.⁽²⁴⁷⁾

We shall never understand the meaning of the naked Michael and his sacred mount, nor the nature of the dragon he fought until we are able to realise that these priestly editors of the now lost Messianic Scriptures were, as A. D. Howel-Smith says of the Chronicler, " of the same breed as the authors of the Isidorean Papal Decretals, the *Donation of Constantine* (see note 148), the *Acta Sanctorum* (see note 188) and other ecclesiastical forgers of the Middle Ages, who had no scruple in lying " for the greater glory of God or for the pecuniary profit of men."⁽²⁴⁸⁾ Moreover this new Bible did not come to be regarded as " divinely inspired " until after all contemporary critics had been brutally massacred by John Hyrcanus (c. 135 B.C.) and his successors. Not only was the temple of Samaria destroyed but whole cities throughout Lower Syria levelled to the ground in the interests of what was then a new fanatical religion.⁽²⁴⁹⁾

Clearly this radical change destroyed a potential spiral of happiness growing under the glamorous name of Israel and turned it into a spiral of violent destructiveness. Once again this points to the urgent need for national deep-analysis, for when the last important traces of Israel were thus savagely destroyed in Asia

Minor, only in Ancient Britain did the true Messianic religion survive.

Both Ancient Israel and Britain had their sacred mounts, their Messianic stones, their oaks, their Allons, their prophets and their cheerful festivals of peace and good-will. Another striking identification occurs in Mount Camel in Britain and Mount Carmel in Palestine. It was on Mount Carmel that, according to Phoenician sources quoted by Josephus, Elijah suffered a humiliating defeat at the hands of the prophets of Baal.⁽²⁵⁰⁾ The Roman Emperor Vespasian paid a visit to this hill-top and declared that there was nothing there; but that Carmel was the name of both a hill and a God.⁽²⁵¹⁾

It is clear from this that on Mount Carmel the old religion survived until Roman days, and had nothing whatever to do with the Jewish Temple at Jerusalem. In later times Dr. M. Hamilton tells us Mount Carmel became known as Mount Elias, and that Elias is obviously the Christianised form of the Sun-God Helios who was worshipped on the top of the Mount.⁽²⁵²⁾ In Britain it seems it was during the building up of the Arthurian legends that the Be Alan of the Dinsul was sometimes given the name of Camel, as in Queen's Camel, and ultimately became romanticised as the famous "castle" of Camelot. The river Camel where Arthur was slain was alternatively called the river Alan.⁽²⁵³⁾

That this one word -L-N should have such an extraordinary variety of meanings both in Britain and Near Asia would seem to dispose altogether of the orthodox contention that the identification of the British Bael and the Semitic Baal is "courageous" and "doubtful" (see note 193). It is incredible that such identical complexity should have arisen independently in two entirely separated parts of the world. Moreover it strongly supports the contention that the mantle of lost Israel did fall on Ancient Britain.

With the coming of the Bronze Age, Michael replaced the earlier Bael or Balan. Michael first appears in history in Mesopotamia as Mi-Ki-Gal about 2400 B.C. when the name applied to the great harvest festival and harvest month.⁽²⁵⁴⁾ In the Old Testament Michael first appears as "one of the chief princes of Persia."⁽²⁵⁵⁾ In Britain his principal festivals were Midsummer, when he slew the Dragon; and the Harvest, when he appeared, like Amsu as God of Fertility.^(255a) The goose which was sacred taboo in Ancient Britain⁽²⁵⁶⁾ was also sacred to the Roman God of Fertility and Gardens,⁽²⁵⁷⁾ and to this day we still slay the goose on Michaelmas Day.

MICHAEL'S MOUNT

September when by custom right divine
Geese are ordained to die at Michael's shrine. (258)

Michael and George, as will be explained in the next chapter, were the Heavenly Twins, the famous Naked Horsemen. "Was Michael naked?" was the key question at the trial of Joan of Arc. (259) There is reason to believe that the change from the Balan to Michael indicated a rise in the cultural scale and a considerable refinement of the crude older ceremonies. Centuries later, after the collapse of the Roman Empire, when Europe had become almost totally illiterate and in chaotic violence, Britain was the sole beacon of light to the Dark Ages. The spread of learning—chiefly from Ireland—the high idealism of the Arthurian legends and Britain's Orders of Knighthood did more than any other single thing to civilize Europe, and these she inherited from the long forgotten cult of Michael's Mount.

The great St. Augustine (c. 400 A.D.) laid it down as a rule of the Church that "Christians ought not to reject a good thing because it is pagan." (260) But in course of centuries we have come to regard everything that was pagan as bad, and everything Christian as good. No country in the world has suffered so much from this over-simplification as Great Britain; for we no longer realise how much that was good in Ancient Britain did carry on into the mediæval and modern world, nor do we understand what underlies the law which would forbid the Leader of the Heavenly Hosts from reappearing in Britain—in fact anywhere in Christendom—on the Great Day of Armageddon.

CHAPTER 10.

THE NAKED HORSEMEN.

THE Cult of the Heavenly Twins, or Sons of Thunder, was at one time widely distributed over the whole world. The Açvins or Twin Horsemen are mentioned more than four hundred times in the Rig Veda. The Dioscuri, who rode horses at the battle of Lake Regulus as Castor and Pollux, are late stages of their development. In the first instances, we are told by Dr. Rendal Harris :—

It is better to think of them as the Great Twin Brethren, without special names or descriptions and without their horses It is certain that they can be regarded as typical Saviours of persons in disability and distress. (261)

About 2500 B.C. there must have been an Indo-European civilization in an area of central Asia slowly turning into desert. Although we have discovered no traces, it must have been in some ways more advanced than the contemporary civilizations of Sumeria, Egypt and Crete, because these Indo-Europeans were the first to discover the wheel, the potter's wheel, to tame the horse, and invent chariots. It would appear that it was in this lost civilization that the great British symbols, Andrew with his Unicorn, Michael and George with their Red Cross, and Britannia with her helmet, trident and crossed shield first evolved into their complex pattern.

The first great migration took place about 2000 B.C. when they over-ran Persia, captured Babylon, caused Twelfth Dynasty Egypt to collapse, and finally settled in north Asia Minor. There, as the Hittite civilization, they flourished until about 1200 B.C. This epoch corresponds roughly to the rise and fall of the sixth and last city of Troy.

A second migration passed over the Hindu Kush into India about 1500 B.C. (262) They brought with them those legends of the Twins which are now incorporated in the Rig Veda, which work—world-famous as it is—has never been fully translated into English as it is under the puritanical taboo.

A third wave passed across south Russia about 1100 B.C. Some settled in Macedonia, and others passed on and invaded both Italy and Greece. (263) These were the Dorian Greeks whose God

Zeus replaced the older Cronos, and who captured Troy. Another indication of a lost common origin will be found in the many similarities between the Indian Ramayana Epic and Homer's Iliad.⁽²⁶⁴⁾

The Cambridge Ancient History tells us that when they first invaded western Asia

they brought with them from central Asia the horse (and) the Gods Indra, Varuna, and the Natasy Twins. Moreover their chief God is said to have been Shuriyah—the Indian Surya, the Sun.⁽²⁶⁵⁾

They also brought with them their sister—the Maiden Surya, who is either the Sun, or the daughter of the Sun.⁽²⁶⁶⁾ This is the maiden who in so many legends gets into trouble, is captured by a dragon, or tied to a tree and rescued by the Heavenly Twins. In Greece she was Helen, or Helena, the sister of Castor and Pollux, and doubtless underlies the story of Helen of Troy.

From Dr. Rendal Harris we learn that the Heavenly Twins were river-gods who go to sea. They first taught men to build ships, hollowed out of the sacred oak. They protect sailors from the dangers of shallows and of the seas. They founded the first cities. They invented the ox-drawn plough of stone and wood. They were deities of rejuvenation, and generally promoted fertility in nature and man. They healed the sick, especially the blind. They appeared upon battle fields as the harbingers of victory.

As a rule the Twins are the benevolent friends of man, the "Good Saviours" to whom appeal is made in all times of trouble, at home or abroad, in peace or in war, on land or on sea. But that must not obscure the fact that they are sometimes extremely angry and greatly to be feared. Occasionally they destroy whole cities; and, as a general principle, they are capable of acting in contrary manners. They can make good weather. They can make bad weather, give rain or withhold it, build a city or reduce it to ruins, open the eyes of the blind, or make those blind who now see.⁽²⁶⁷⁾

One of the legends of the Twins is of singular interest because in a manner that would seem to be highly unscientific it has fulfilled itself as historical fact, and underlies one of the primary developments in the history of both Judea and Britain. This legend says that the elder Twin is always divine and the younger one human, but that the human twin always supplants the divine one.

A classical example of this legend, given by Dr. Rendal Harris, is that of Esau and Jacob. In primitive patriarchal communities all girls had sexual freedom until marriage. Dr. Robert Briffault has collected records of this custom from all over the world.⁽²⁶⁸⁾

The children of such unions were considered a blessing to the clan and to be of divine parentage. Among these people every girl was considered to be a virgin until she had her first child, and every such child was thought to have been conceived without human intervention. In consequence such children were dedicated to the religious life as prophets or Sons of God, and named after the God. (See note 206).

After marriage the woman's subsequent children were regarded as the children of her husband, and under patriarchal law they inherited the father's goods. In the story of Isaac, Esau, the elder twin, was the divine one. He was the Red Man⁽²⁶⁹⁾ that is the thunder prophet, for red was always the colour of thunder and of the Divine Twin. Jacob, whose name means "The Supplanter"⁽²⁷⁰⁾ by criminally deceiving his blind and dying father, stole from Esau both the birthright and the blessing.

As material wealth increased with civilization the second son—the heir—became vastly more important than the elder one—the family prophet. Thus the Sons of God gradually lost their social and religious status. In early European history all great heroes and men were bastards such as King Conchiobar,⁽²⁷¹⁾ Cuchilean,⁽²⁷²⁾ Mongan,⁽²⁷³⁾ Fion,⁽²⁷⁴⁾ Conaire,⁽²⁷⁵⁾ King Arthur,⁽²⁷⁶⁾ Roland,⁽²⁷⁷⁾ Clothwig,⁽²⁷⁸⁾ Charles Martel,⁽²⁷⁹⁾ Charlemagne,⁽²⁸⁰⁾ and William the Conqueror, known as William the Bastard, son of William the Devil. Not until later did the ascetic taboo bring bastardy into disrepute so that the king's bastard first ceased to be the king's heir, and gradually fell from being a great noble with the bar—sinister to becoming a social disgrace. But in Asia the naked prophets were held in the old reverence until recent times.⁽²⁸¹⁾ In India the yogis of one school, held in great reverence in the Eighteenth Century, sometimes make a vow to deflower two or three thousand virgins; "and go about performing this charity whereupon they are held in great veneration."⁽²⁸²⁾ There is no doubt that such yogis are the lineal descendants of the Heavenly Twins in their functions of rejuvenation and fertility.

It was not until the time of the Indo-European invasion of western Asia that the Great Twin Brethren first appear as the Naked Horsemen. It was then that they were known as Mi-Ki-Gal and Geur or Gorgos.⁽²⁸³⁾ Michael was the Divine One, the Heavenly Messenger, and as we have seen, became Patron of the Sacred Mounts, and Midsummer and Harvest Festivals. He would also

seem to have presided over May Day, as the Christian Festival of "The Apparition of St. Michael" held on May 8th was suppressed by Pope Benedict XIV in 1742. In one Greek legend the elder Twin was known as the hunter and his dog.⁽²⁸⁴⁾

Gorgos was the human twin who played the humble rôle of representative or leader of the agricultural workers, and possibly that of the jester. The nature of the part he played in the ancient festival mimes survived in Mediæval Greece so that he was there given the epithet of "the Drunkard"; and in Crete he became known as the "Mad St. George" on account of the licence of his festivals.⁽²⁸⁵⁾

Sir James Frazer wrote :—

We may conjecture that with women a powerful motive for submitting to the embraces of the "holy men" is a hope of obtaining offspring by them, for in Syria it is still believed that even dead saints can beget children on barren women, who accordingly resort to their shrines The Saint who enjoys the highest reputation in this respect is St. George.⁽²⁸⁶⁾

At the time of the rise of the Roman Church there were many ancient shrines to the Heavenly Twins; one by one these were gradually Christianised. One such displacement was the shrine of Castor and Pollux at Constantinople, on the Bosphorus, which became the church of the twin saints Cosmos and Damien. As Patrons of the narrow-seas, they also appear as St. Michael's Mount in Brittany and St. Michael's Mount in Cornwall. There are many places where they became saints Cosmos and Damien, including the great Temple of Castor and Pollux in Rome.⁽²⁸⁷⁾ One was at Sandwich in Kent where there was a Carmelite Friary dedicated to Our Lady of Carmel with an altar to SS. Cosmos and Damien.⁽²⁸⁸⁾

That there should be shrines to the Heavenly Twins both on the Bosphorus and the English Channel, at Troy and at London; that the name Michael was first found in Asia Minor, and that St. George of England is George of Cappadocia are all indications of a very strong link between Troy and Britain. The evidence does not depend on the Twins alone. It is cumulative; as detail piles on detail it is not so easy to explain away as was the old unsupported tradition that it was under Trojan rulership that London was known as New Troy.

The Cross of St. George can similarly be traced back to Asia Minor. The Red Cross of the Twins is one of the earliest religious symbols known to man. Nothing is more astonishing than that

the Cross should have come to be regarded as pre-eminently a Christian symbol. Amongst the pygmies three crossed sticks in the form of a cross is a sign of Divinity.⁽²⁸⁹⁾ Bushmen make the sign of the Cross to ward off evil spirits,⁽²⁹⁰⁾ as did many Red Indian tribes.⁽²⁹¹⁾

“The use of the Cross as a religious symbol in pre-Christian times,” we are told in the *Encyclopædia Britannica*, “and among non-Christian peoples may probably be regarded as almost universal, and in very many cases it was connected with some form of nature-worship.”⁽²⁹²⁾

Primitive people regarded red as the colour of life. They painted the bones of the dead with red ochre apparently to give them life, or hope of renewal. All over the world red was a sacred colour and objects painted red became sacred taboo.⁽²⁹³⁾ For festivals the statues of even such sophisticated Gods as the Greek Dionysus,⁽²⁹⁴⁾ and the Roman Jupiter were painted red.⁽²⁹⁵⁾

It is clear therefore that a cross painted red had a much deeper significance than one of plain wood or stone. Such a cross was regarded with special veneration by the Egyptians and called “The Red or Fiery Cross”⁽²⁹⁶⁾; and was also found in association there with “MAKH of the Red Cross.”⁽²⁹⁷⁾ The Red Cross appears as a standard of “Universal Victory” in association with the Heavenly Twins as far back as 2000 B.C.

A torch tied to such a cross, and carried lighted from village to village by a swift runner, was also a sign of danger, and a method of rallying the clan to war. This latter has partly survived as the Olympic Torch. We can therefore have little doubt that the Red Cross of England not only ante-dates Christianity but was known here long before the coming of the Romans.

The Red Cross of the Twins was always found on a white ground, red and white being essentially the colours of the Twins. In their rôle of healers, the Caduceus is an elegant refinement of Hermes’s Healing Rod, which was originally a crude phallus painted red and white. In the Middle Ages there were no doctors, and it was the barber who acted as the surgeon, to whom the wounded went for their first and only aid. St. Cosmos, who was a common substitute for the God Michael, became the patron saint of the barbers. Hence in mediæval times the crude rustic phallus evolved into the red and white striped barber’s pole.

Another of the old fertility symbols was the goose which is still associated with Michaelmas. The goose was in many legends

the father of the Twins. In the Egyptian creation-story Tem, the Father of the Gods, was sometimes called "Seb the Great Cackler." With the growth of cities the rustic goose was replaced by the more elegant symbol of the swan⁽²⁹⁸⁾, and, in the story of Leda and the Swan, it is the Swan who is the father of the Twins. The Swan Knight of the Holy Grail indicates a similar refinement in Britain. On the other hand The Roman Twins, Romulus and Remus, were given an especially fierce character in that they were suckled by a wolf. The Roman Wolf and Alan, the British Wolfhound, indicate the eternal conflict between totalitarianism and democracy.

In nearly all mythologies, when two Gods are spoken of as father and son, it usually means that the father belonged to an earlier epoch than the son: as in the case of the Bronze Age Cronos and the Iron Age Zeus. The sacrifice of the goose on Michaelmas Day is another indication of Michael having replaced an earlier fertility God.

London is essentially a city of the Heavenly Twins. They will be found carved on the west pediment of St. Paul's Cathedral which is the shrine of the Order of St. Michael and St. George. Many of their ancient attributes are very characteristic of Britain. They are river Gods who go to sea. They build ships. They heal the sick. Their Red Cross, incorporated in the Union Jack, goes to war both on land and sea, and, as the Red Cross flies over the hospitals. Moreover they were also patrons of all forms of athletic sports and games.⁽²⁹⁹⁾ But although the statues of Gog and Magog lived in the Guildhall until it was destroyed in an air raid, their legends have been suppressed, in striking contrast to those about Romulus and Remus.

In Britain the Heavenly Twins always appear in their ancient rôle as the Dioscuri or Naked Horsemen. On the medals of 1914-1918, and on the now vanished gold sovereigns, it was St. George who rode naked to fight the Dragon. But until the Middle Ages it was not St. George, but St. Michael, who appeared as the Naked Horsemen on English coins. The Michael mintage of Edward IV was also connected with some of the old attributes of the God Michael for they were in popular demand for touching in the miraculous cure of the King's Evil.

The change from the Michael mintage of the Fourteenth Century to the George mintage of the Nineteenth reflects a change in Britain's patron saint which is not generally realised. It seems

to have been brought about by ecclesiastical influence because of the great Armageddon prophecy in Revelations. The change, however, exactly corresponds with the world-wide legend of the human twin rising up to supplant the Divine One.

The Greeks told of the same social change in mythological terms when they said that Bacchus turned into Pluto.⁽³⁰⁰⁾ One of the emblems of Bacchus was the famous phallus called "Liber."⁽³⁰¹⁾ Because it was supposed to have magical powers of renewal they sometimes set it up on graves as a sign of resurrection. So by a strange fate of evolution the symbol of life turned into an emblem of death; and by the time the tombstones had lost their original meaning, society had actually changed from a Bacchic community into a plutocracy, that is a rule of a wealthy class with its severe moral restrictions. In parts of Greece, however, shrines of Bacchus lasted until they were turned directly into churches dedicated to St. Michael.⁽³⁰²⁾

Michael the Harvest God was held in far too high regard both in England and France ever to suffer the fate of the Horned God of the villages and be turned into the Devil, as Bacchus turned into Pluto. Even among the saints he was pre-eminent as the archangel. One may recall how in Paris the Boulevard St. Michel and the Rue du Dragon lead out from the Shrine of Cernunnos on the island of Our Lady, one time Queen of Heaven, to the Elysian realms of Montparnasse. It was not until such pious kings as Canute and Edward the Confessor withdrew the royal patronage from the old Michael festivals that they became local folk-customs and that the importance of the Michael symbolism waned.

On the other hand as material wealth in Britain began to increase and the country to become more and more a plutocracy, then did George, the human twin who inherited the material wealth, rise in importance. Finally, like Jacob, George usurped both the birthright and the blessing from his divine brother. Thus to-day we have the somewhat absurd evolution wherein the Jester, the mad, drunken "and infamous St. George has become transformed into the renowned St. George of England, the Patron of arms, of chivalry and of the Garter"⁽³⁰³⁾, while Michael, like Arthur, has become the disregarded emblem of a future Messianic Age.

CHAPTER II.

ANDREW AND HIS UNICORN.

THE Heavenly Twins always accompanied the Storm God. As Boanerges, or the Sons of Thunder, they symbolised the thunder and the lightning ; Indra was the storm. Indra was the chief of twelve gods who presided over the Golden Mountain, Meru, where he solaced them with nectar, heavenly music and celestial dancing girls.⁽³⁰⁴⁾

His favourite festival was called " Indra's Banner," where banner apparently means the May Pole, as a symbol of the Tree of Life.

Lift ye up a banner on the High Mountain⁽³⁰⁵⁾ for his banner over me is love.⁽³⁰⁶⁾

The banner was raised aloft seven days before the full moon of the month Açvina (September-October—the month of the Twins). The Karm-festival among the Urans is probably akin. Both are fertility festivals as are the well-known May-tree festivals.⁽³⁰⁷⁾

Hence " Indra gives us the the girls we want,"⁽³⁰⁸⁾ and his character, according to the missionaries " was of the lowest."⁽³⁰⁹⁾

Highest of Immortals bright
God of Gods by lofty might
He before whose prowess high
Tremble earth and upper sky.
He is, mortals, hear my verse,
Indra, Lord of Universe.

RIG VEDA.

Indra was sometimes depicted as a goat. Here we have an example of how the Solar Cult imposed itself upon the older May-November religion, but did not supersede it. Clearly, Indra when he wore his headdress of goat's horns was assuming the ancient rôle of the Horned God. But when he appeared as God of Fertility he was regarded as " one horned " like the Cerne Giant ; and in the Rig Veda we find the earliest trace of the old English legend of " the lion and the unicorn a-fighting for the crown," for " Indra for the Goat did to death the lion."⁽³¹⁰⁾

The evolution of the ancient Goat-God into the Unicorn is typical of the sophisticated refinement of urban civilizations ; as when the vine replaced Sir James Frazer's " deplorable old conical stone."⁽³¹¹⁾ As the ascetic priests triumphed over the old prophets both the dog and the goat fell into disrepute. Originally it was

far otherwise, for Indra was leader of the Heavenly Host,⁽³¹²⁾ and, as the Goat, vanquished both the Dragon of Darkness and the Wolf of Death.⁽³¹³⁾

In the Hebrew legends of the escape of the Hebrews from Egypt they were led across the Red Sea under the symbols of the lion and the unicorn. "He hath as it were the horn of a unicorn The people shall rise up as a great lion."⁽³¹⁴⁾ Here the lion was the Lion of Judah and the unicorn the Unicorn of Israel. All through the Old Testament there is a constant conflict between Judah and Israel. Israel and her prophets were the worshippers of Baal (see notes 353, 354) and bitterly resisted the encroachments of the priests of Judah.

But here again, as in the story of Esau and Jacob, Judah gradually stole both the birthright and the blessing from Israel. Only the Jews of Judah returned from the Babylonian Captivity. Israel was lost before and is still lost. Yet Judah now claims to be Israel, just as Jacob did; but the Jews failed to trap the unicorn; their lion stands alone. Like Indra who was sent "bound in chains to a far country," and Cronos sent bound in chains to Britain (see note 178) the chained unicorn is to-day found only in Britain.

Indra, as the Storm God, possessed the magical thunderbolt which took the form of a four-angled bolt.⁽³¹⁵⁾ A. B. Cook has shown that :—

The cult of the Sky God amongst our ancestors was connected with the cult of the Sacred Tree, the oak being the tree most commonly honoured We shall find the best explanation of this equation between the Sky God and the oak tree in the lightning which passed from the one to the other, and makes a secondary dwelling in the tree which it struck The Thunder Stone, when identified, became a sacred object and in some points of view regarded as Divine.⁽³¹⁶⁾

(The oak being struck by lightning far more frequently than any other type of tree).⁽³¹⁷⁾

A clan fortunate enough to possess such a thunder stone would carry it into battle believing that the lightning still lived in the stone and that it was therefore an all-powerful weapon. Several such stones, which will be mentioned below, survived in Scotland (see note 334). Sometimes they were fixed on a wooden handle and carried aloft which is the original of the "stone of the standard" from which has evolved our regimental and national flags. In other cases the thunder-stone was set like a jewel in the head of a double-headed battle-axe.

J. S. M. Ward shows that one of the most primitive symbols of Divinity was three crossed sticks ✧ or †

which is used to-day in certain higher degrees of freemasonry, particularly the Templar group. In its primitive form it was the ideograph for Amsu who corresponded to our Christ.(318)

Dr. Churchward tells us that the masonic gavel ✧ or † is a symbol of Power. Another masonic writer says :—

It is extraordinary that while the true knowledge of God was lost in most nations of the ancient world, there are few but retained vestiges of His Name. Hale deduced the Name in many nations from the primitive Hebrew root AL ✧ signifying *Power*.(319)

The development of the primitive sign |◀ into the double-headed axe |◀◀ is clearly to be seen at Knossos in the "House of the double-axe."(320)

This is clearly the intermediary stage. In its final development the X Cross of St. Andrew, being white on blue, represents the lightning on the sky.

We are told by T. A. Waddell that :—

The existence of a pagan shrine of Indara at St. Andrew's, Aberdeen, in the pre-Christian period is confirmed by the unearthing there of a considerable number of pieces of ancient sculpture and fragments of crosses bearing, not Christian symbols, but those which from their appearances are believed to have been Pagan and had "been broken up and thrown aside as rubbish,"(321) or buried as casing for graves or built into the foundations of the 12th century cathedral. Amongst these are fragments of Hittite-Sumerian pattern In Scotland the Apostle, bearing the Aryan and non-Hebrew name of "Andrew" was presumably an Aryan Hittite and the priestly legend attached to him incorporates part of the old legends of his namesake Indara The "X" cross now commonly called St. Andrew's or in heraldry "cross-saltire" is figured freely on Hittite, Sumerian, and Phoenician sacred seals as a symbol of Indara "X" crosses are also found, more or less identical, in pre-historic monuments and pre-Christian coins as the St. Andrew's Cross It was especially associated with Indara as Bel as seen in the ancient Hittite seals, representing Indara slaying the Dragon of Darkness.(322)

Another close association between Indra and St. Andrew will be found in the

extraordinary and hitherto inexplicable folk-lore tradition attached to St. Andrew's Day, for maidens desiring husbands pray to that saint on the evening of this festival, November 30th, as described by Luther,(323) who stated that in his country on the Eve of St. Andrew's, maidens strip and pray to that saint for husbands. The same custom prevailing among the Anglo-Saxons,(324) is now explained by Indra's traditional bestowing of wives.(325)

Indara was in fact driven from India "for loving too many

milkmaids." Indra and Brahma (who is sometimes known as the Goose God) were cursed by Savasrate in the following words:—

By the powers I have obtained, by the performance of sacrifice, may Brahma never be worshipped in temple or sacred place, except one day of the year; and Indra, since thou brought the maid to Brahma, thou shalt be bound in chains in a strange country. (326)

Indara of Troy and the Hittites was contemporary to Cronos who was sent in chains to Britain. Cronos seems to symbolise the Storm God in his aspect of the Benevolent Father God. Also known as Father Time, he was white-bearded and he wore the traditional red-robos of the Twin Cult. In this aspect he seems to have fulfilled the Indian curse, for as Father Christmas he is worshipped only one day of the year when he brings back to earth the now forbidden Tree of Life. The Christmas Festival has come down almost unchanged from the Roman Saturnalia (Saturn corresponding to Cronos and Indra) the ancient licence is now symbolised by kissing under the mistletoe, while the custom of exchanging presents is of great antiquity. (327)

In a remarkable manner this complex pattern of the Solar Twin cult occurs in the New Testament. For the transfiguration on the mountain Jesus (who like the Gods of the Mount had twelve followers) was accompanied by Peter—the Rock or Thunder Stone, and James and John who were called "Boanerges the Sons of Thunder" one of whom, like all the Twins, was known as "The Divine." The whole ritual must have been connected in the minds of contemporary folk, with the Solar Cult symbolism.

This poses a very profound question ; for either one must reject the historicity of the Gospels on this account or acknowledge that the mothers of the apostles were influenced so to name their babies that as adult men they were able to take part in a pre-destined rôle, and moreover gave them non-Hebrew names such as no Hebrew children had had before. The arguments which are used for accepting the historicity of the Gospels should be applied to the history of Britain ; for the reasons given for sweeping all history from the British Chronicles would, if applied to the Gospels, deprive them also of their right to be accepted as fact.

Those who deny an historical core to the British Chronicles must do so on the assumption that the cult of the Heavenly Twins with all its amazingly corresponding detail arose independently in both Asia Minor and Britain. Another detail in this pattern is the association of Andrew and the Twins with London. There, at

Andrew's of the Cornhill, Indra's Banner reappeared as the Great Maypole of London (130 feet high) of which Chaucer wrote:—

Right well aloft ye bear your head
As ye would bear the great shaft of Cornhill.

It is interesting to note that the use of the word "shaft" connects the old Maypole with the Thunder Cult, for it means a slender pole, or bolt, or stroke of lightning. The great Maypole of London was not finally destroyed until 1552 A.D.

The commoner form of the Thunder Stone was the "herme" which was itself anointed, but also upon which the elected one was seated for the ceremonial anointing which changed the man into the Man-God. Such stones were found in every country till the Iron Age.

Edward Carpenter writes:—

Sir James Frazer in *Folklore in the Old Testament* has a chapter (in vol. ii) on the very numerous sacred stones of various shapes and sizes found and spoken of in Palestine and other parts of the world Anointing them with oil, he assures us, is a widespread practice sometimes by women who wish to obtain children following this clue it would appear likely that the *lingam* thus anointed and worshipped in the temples of India and elsewhere is the original Chrestos adored by the human race from the very beginning. (328)

In the old days the man anointed on the sacred stone often took the name of the God, as in the case of Esh-Baal of Tyre. Later we find Antiochus IV of Persia was called *Theos Epiphaenus*; that is "God Manifest," (329) and in 121 B.C. one of his successors Mithradates was called *Christos*. (330)

In the early days of Rome kingship was abolished and a republic set up. But the most sacred emblem was the phallus of Jupiter, called also Jove's Thunder-bolt. This was placed in the especial care of the Vestal virgins. (331) During the Carthaginian war the "Black Stone" of the Magna Mater was brought to Rome and in course of time the two stones became identical.

With the rise of the Empire the Emperors claimed to be the sole god on earth. Henceforth the kings of the May and others locally anointed were, when caught, crucified; and all the local stones carried away to Rome so that the people should thus look to Rome as the place where their sacred emblem was to be found. Consequently when the official religion was changed to Mithraism, Mithra was said to be the *Theos ek Petras*, the "God from the Rock."

The Bishop of Bristol tells us that:—

The word Peter (petra-stone) was very closely bound up with Pagan mythology. In southern Russia a stone has been found with

the inscription *Petrae Genetrice*, i.e., the stone that begets the God: "The God out of the womb of the stone was a consistent epithet for Mithras." (332)

Hence it came about that "the stone which the builders rejected became the headstone of the corner"; the Peter upon which the Church was founded.

Nothing is known of the fate of the coronation stone or stones of pre-Roman England and Wales, but many local ones must have survived. As late as the Eleventh Century A.D.

the laws of Canute earnestly forbid heathenism that is that they worship fire wells, stones or forest trees of any kind. (333)

In Scotland such stones survived even later.

It is said that at one time each village in the Highlands once had an unhewn one, on which libations of milk were offered to the local fairy. (334)

Each Scottish Clan also had its own thunder stone in the keeping of the chief.

Such stones were believed to have healing properties, a certain power showing itself through them the Stewarts of Ardvocerlech in Perthshire have a precious stone called the Clach Dearg or "Red Stone," the size of a hen's egg, which cures distempers. (335) The Robertsons of Struar have another called the Clach-na-Bratach or "Stone of the Standard" which was carried into battle to bring victory. (336)

A similar stone, green in colour, called Muluy, was carried by the Macdonald of the Isles and always brought victory when he threw it among the enemy A still more remarkable charm is the Lea Stone said to have been oriental in origin, a small dark stone set in the reverse of a groat of the time of Edward IV. In the reign of Charles II the inhabitants of Newcastle sent for a loan of it to cure the plague, offering a bond of £6,000 for its safe custom. (337)

Only in Ireland and Scotland, beyond the range of the Roman armies, did two famous European coronation stones survive: the Stone of Fal at Tara upon which the kings of Ireland were anointed, and the Stone of Scone, now in Westminster Abbey. The anointing of the king upon this stone represents an unbroken continuity of custom of immense antiquity. Impressive as is the Coronation ceremony even to those who vaguely believe it began in the Dark Ages, it is nothing like as impressive as it would be if it was fully appreciated that the rite not only outdates Greece and Rome, but Babylon and even Egypt's pyramids.

CHAPTER 12.

BRITANNIA AND ST. PAUL'S.

IT is a strange thing that we in Britain neither know the origin of the name of our country, nor apparently make much effort to find out. An old encyclopædia once described Britannia as a "Roman goddess," and this arrant nonsense has been vaguely accepted by all educational authorities, so that generations of the children of this great Commonwealth are allowed to grow up in total ignorance of what is, after all, the most important aspect of a country's history—its origin; and also one of the things hostile propaganda is always most anxious to make obscure.

The root of the great words "Britain" and "Britannia" is in their consonants Br — t, and therefore in dialects varying not only locally but over long periods of time, the root word might have been written or spoken as Brat, Bret, Brit, Brot, Brut, or Bryt. It is obvious that the word Britain, Brytan, or "Great Britannie" (c.1600 A.D.), derives from the same source as Brittany: just as do Briton and Breton. Both have similar Arthurian legends; both have an Insula-av-Alan where Arthur was buried; ⁽³³⁸⁾ both have great stone circles found nowhere else; both Welshmen and Bretons understand each other to this day. All this points to a common origin for the name Br—t (and the Arthurian legends) at least as old as 2000 B.C.

Brut, the name of the traditional first Trojan king, may have been a title meaning king-paramount, similar to the Anglo-Saxon royal title Brit-walda. Humphry Lhyud (1570 A.D.) was of the opinion that the ancient name of our island was the Cymric Welsh *Prydain*. ⁽³³⁹⁾ This suggests that the impact of Latin and Saxon, to say nothing of change of pronunciation over a thousand years caused confusion between the consonants t and d; and that Brut or Brit equates with Brid; all are titles of the Great Mother. We therefore find the common origin in Crete where the Mother Goddess was called Britomart. ⁽³⁴⁰⁾ Britomart was, like Britannia, associated with Diana. She had a Divine Son who was first known as Dionysus and later as Pluto; ⁽³⁴¹⁾ and just as the Greek Bacchus turned into Pluto so did the British Horned God in the Midsummer pageantry. (See below note 366-367).

In the early agricultural epoch the wise-woman was not merely the Mother of the Clan, but in every respect its chief. There were no prophets or priests when she was the voice of the Oracle. People went to her when in trouble ; she announced auspicious days for hunting, sowing, ploughing and festivals. She would have been the first individual dependent on others for her food. When there was a successful hunt, or a herdsman killed a domestic beast, they did not give her a portion but brought the whole animal or carcase to be sacrificed upon her altar. The sacrifice of a deer on the steps of St. Paul's lasted until the reign of Queen Elizabeth I. (See note 364).

The first sacred object that has been found associated with an image of the Great Mother was a tribal phallus. (See note 61). Now in the ancient world a phallus was believed to have magical powers, especially of warding off the evil eye, bad spirits and even savage animals. Hence they were often erected, like a barber's pole, over the doors of houses and the entrances to villages. There were huge ones outside the gates of Rome⁽³⁴²⁾ and on the chariots of Roman generals.⁽³⁴³⁾ The phallus which protected the gate of Belin in London survived until the Seventeenth Century and became known as the Billingsgate Bosse. The local porters would insist on passers-by kissing the Bosse or else they picked them up and bumped them on the seat against the stone.⁽³⁴⁴⁾

But, as from the earliest times, the cross of three sticks had similar powers, (see notes 84 and 318), they too were erected at entrances to the town and on the approaches to the shrine of the Great Mother. This is the origin of the great London crosses and those around Glastonbury. Only a few like Charing Cross were Christian and were called " Eleanor " crosses after the queen (but strangely even that name is of the ancient root L + N).

Another London Stone that survived nearly to the Seventeenth Century was known as " Paul's Stump." It was set close to the site of Wren's cathedral ; but it seems to have lost all sense of its ancient sanctity and even its legends. Nevertheless it must have once been of much importance to have survived so many stormy centuries in the city's centre. It was probably one of the last relics of the sacred enclosure on Lud's Hill. St. Paul's Cathedral would originally have been a solitary oak tree, or a Holy Oak in a grove near which the Great Mother had her altar and tended her sacred fire. Very early in the evolution of the shrine two stones were set up on either side of the altar or beside the tree, which were the

“ heap and pillar of the witness,”⁽³⁴⁵⁾ upon which men swore oaths, and which by extension became boundary stones.⁽³⁴⁶⁾

These were the customs of that remote period known as the “ tree and pillar cult ” and arose from the fact that it was

the custom for the person who took an oath to place his hand under the “ thigh ” of the adjurer.⁽³⁴⁷⁾ This practice arose from the fact that the genital member, which is meant by the euphemistic expression “ thigh,” was regarded as especially sacred No more impressive ceremony could therefore have been performed in early days than for a man to touch the symbol of creation even at the present day this form of oath is to be found amongst certain Arabian tribes⁽³⁴⁸⁾ who actually swear by the “ Phallus of Allah.”⁽³⁴⁹⁾

This form of oath-taking must have lasted far longer in N.W. Europe than we have been led to believe, because we get from it such important words as “ testament,” “ to testify,” and the French “ témoin,” etc. In fact, the Old Testament originally consisted of the “ two stones of the testimony,”⁽³⁵⁰⁾ yet when the Christians added a third it still remained two.

We may therefore picture the Great Mother sitting under her tree, above her any bird with red feathers, such as a robin or woodpecker, and later the domestic fowls when roosting were regarded as thunder birds and of sacred omen. She would have had in her keeping the sacred stone—possibly in the form of a stone-headed mace. There would have been a bundle of torch-crosses leaning against the tree ready for the runners in case of danger. Her dog would have been lying at her feet ready to warn of the approach of strangers, and her geese would have been wandering in the field nearby. At first sight it is hard to realise that in this simple rustic scene will be found nearly all the elaborate symbolism of a great gothic cathedral. The earliest known temple was in Crete and from the *Hagia Trida* sarcophagus we know it was a kind of small roofless erection with an altar and a pillar standing in front of a small roofless building, in the middle of which was a Sacred Tree, and that amongst the furniture found there was a double-headed axe.⁽³⁵¹⁾ We also know that the male played only such small parts in the rites as porters or spectators. (See note 63).

The next stage in the evolution will be found in the temple of Het-Ben-Ben at On (Cairo) in Egypt. There at one time was the sacred Persea Tree under which the goose laid the egg which hatched into a Phoenix. “A vignette in the papyrus of Ani shows a pylon-shaped building between double pillars  ”⁽³⁵²⁾

Here the Tree had fallen into decay and been replaced by a building.

The temple of On was the model for Solomon's temple. An old Jewish legend tells us how David, when keeping sheep, was carried up to Heaven on the back of a colossal rhinoceros and delivered from this position through the help of a lion, whereupon he vowed to build a temple of the dimensions of that animal's horn.⁽³⁵³⁾

Here is another version of the story of the lion fighting the one-horned unicorn. The unicorn took David to Heaven and the lion brought him back to earth. Solomon's temple when built consisted of two pillars "Jachim and Boaz" on either side of a huge "porch" or tower which dominated the whole building. The building was sixty cubits long by twenty in height and breadth; the porch was one hundred and twenty cubits high by twenty wide. The whole story seems to be another instance of Judah stealing the birthright and the blessing from Israel, for the building was constructed with the friendly aid of the kings of Tyre, who were worshippers of Baal and would never have helped to build a temple to a God vowed to destroy Baal worship. Moreover we know from the correspondence of the Pharaoh Akenaton that there was a Sun temple at Jerusalem already famous some three centuries before the time of David.⁽³⁵⁴⁾

The next stage in evolution was when the two pillars became the Twin West End Towers, and the "porch" which replaced the Sacred Tree became the central spire, still with its Thunderbird on top. Inside we still find the Tree of Life as oracle in its form of the lectern, i.e., a Thunderbird upon a Thunder pillar—in Durham Cathedral it is a Phoenix—holding on its wings the two Testaments, and over all still flies the Red Cross of the Heavenly Twins. The cross within the circle which symbolised the Great Mother will still be found on the regimental flags which have replaced the ancient stones of the standard.

In the course of evolution the Great Mother gradually fades away into the realms of shades and symbology. This began when men usurped the functions of the prophetesses. At first a man could only be accepted and recognised as a seer provided he married the seeress⁽³⁵⁵⁾ and even then he had to adopt feminine dress. It was for this reason that Hercules and his priests wore female garments⁽³⁵⁶⁾, and on occasions Alexander the Great appeared dressed as the Goddess Diana.⁽³⁵⁷⁾ Little by little as

the male replaced the female in all religious ritual not only did the seeresses disappear but the prophets also until only the priests remained : and to this day they still keep up the ancient fiction that they are female by wearing long robes originally intended to disguise the male.

But before the final disappearance of the Great Mother from her temples and shrines she herself underwent several evolutionary changes. With the coming of the Solar Cult and its divine kings she lost much of her importance both in the religious and social spheres. In the cult of the Heavenly Twins she appears associated with the Sun (see note 266) but by Roman times she changes from a Solar emblem to a Lunar Goddess. In place of the maiden of the Sun she appears as Diana the chaste huntress. Traces of this change will be found in Britain as in the post-Roman shrine to Diana at Maiden Castle,⁽³⁵⁸⁾ and also in the legends of St. Paul's.

All too often the orthodox historian considers mythology and legend to be outside the sphere of historical research. But however vague and legendary may be the change of the Sun Maiden into Diana, there is no doubt that this change was an unmistakable historical fact when related to the character of the women of Britain. In the Solar epoch religious nudity was "common usage" (note 115) and no British woman in those days would have given a thought about being seen unclad, but a thousand years later any male who peeped at an English hunting woman while in her bath would have been likely to learn that her language and her wrath transcended even that of the chaste Goddess herself.

In London when the Sacred Tree decayed and became a stump it was likely to have been replaced by a stone, which acquired the name Pol or Pul which was an ancient title of the Sun God,⁽³⁵⁹⁾ and so became Old Pol's Stump. E. O. Gordon in his *Prehistoric London* gives reasons to believe that on the site of St. Paul's there was an oracle of the hunting days as far back as 3200 B.C. ; and that it became a stone circle about 1900 B.C. ; and that the pointer to the South-East was the famous London Stone still preserved in the walls of St. Swithin's Church. London Stone has often most exasperatingly been called a "Roman milestone," one can only hope our children will not be taught to believe it to be of Russian origin! At Stonehenge the pointer stone was a phallus (see note 218), and phallic rites were rain-making magic.

It is therefore interesting to note that London Stone is at St. Swithin's, who, as we still believe, gives us a wet or dry harvest.

The above dates are astronomical calculations made by the Rev. John Griffith, from the Mounds of Ancient London. There were the White Mount—now the Tower, Parliament Hill, Penton Hill, Tothill—now Westminster and Primrose Hill.⁽³⁶⁰⁾ The calculations indicate that the Solar Cult was imposed upon the May-November years about a century earlier in London than at Stonehenge, as calculated there by Sir Norman Lockyer (see note 173).

That St. Paul's area of London had been a sacred enclosure of that particular open-air type is certain. Henry VIII abolished the right of Sanctuary at Westminster (see note 186) but even he was not powerful enough to abolish it within the city. There it lasted until the close of the reign of James I, in spite of the fact that latterly it became a public nuisance and a haunt of malefactors and that the monastic buildings had long since disappeared. The right of Sanctuary, however, was not in the Cathedral itself, but in the nearby St. Martin's le Grand. St. Martin was said to have been cut up and eaten in the form of an ox, his festival being November 11th, the Feast of the Dead. "This is clear evidence that St. Martin merely took the place of the God Hu who was symbolical of that animal."⁽³⁶¹⁾ It also points to the extreme antiquity of London's Sanctuary.

Between St. Martin's and St. Paul's was an open space in which stood two crosses, St. Paul's and the Broken Cross. This was the place of the meeting of the folkmoot—London's open-air Parliament. As late as the Fourteenth Century this bit of land was of greater national importance than any building erected up to that time. There, according to Stone Age custom, the citizens of London met to elect the kings of England before they could be crowned at Westminster. We have records of the election of Edward IV, Stephen, Edward the Confessor, Edmund Ironside and others; even William the Conqueror submitted to the formula of election before being crowned at Westminster.

Another example of continuity of custom in London, and one even older than the above, took place on the festivals of St. Paul. In January a doe and in June a stag were taken to the cathedral where they were met at the West Doors by the Dean and chapter wearing garlands of leaves or roses on their heads. The deer was then slain on the steps of the cathedral to a fanfare of trumpets

and the proclamation of a public holiday. The head and horns of the beast was set on a spear and taken in solemn procession to the high altar. This ceremony lasted until the time of Queen Elizabeth I.

Canon Simpson, who gives an account of the ceremony, considers the custom is fully accounted for by the rent due from the family of Sir William le Bund for permission given to him in or about 1375 to enclose some acres of land adjoining his park which were owned by the Dean and chapter.⁽³⁶²⁾

This is a typical example of an official "explaining away" when we are diverted from the actual truth by the overwhelming desire for moral welfare. (See note 8.) In the Fourteenth Century the Roman Church was at the apex of her power, and for centuries had been gradually suppressing all rites savouring of heathenism, and would certainly not have permitted a new and obviously pagan custom to have been started, nor would the very conservative Londoners have accepted it.

That it was an ancient custom is clear from the instructions sent by Pope Gregory the Great to Bishop Miletus in 601 A.D. when he (Miletus) was engaged in building the first Roman church on the site of St. Paul's. The Pope expressly instructed Miletus as follows:—

Let the shrines of idols by no means be destroyed. Let water be consecrated and sprinkled in these temples; let altars be erected and relics laid upon them because if these same temples be well-built, it is necessary that they should be converted from the worship of evil spirits to the service of the true God, so that people not seeing their own temples destroyed may displace error from their own hearts and recognise the true God meeting in the familiar way at the accustomed places: and because they are wont to sacrifice many oxen to devils, some celebration should be given in exchange for this.⁽³⁶³⁾

The sacrifice of the deer at St. Paul's *precisely* fulfilled the Pope's instructions, and gives added weight to the words of E. Hull on this subject:—

The solemnity and sacrifice of the buck, the garlands of flowers worn by the clergy and the blowing of horns in the city, and the importance of the days in the Cathedral life as those of its patron saint, all point to some function of a more universal nature than the private payment of a debt for a piece of land. It was evidently a ceremony in which the city as a whole had a part. Camden's suggestion that the custom went back to the worship of Diana the huntress gives a more reasonable explanation.⁽³⁶⁴⁾

It is true that Sir Christopher Wren was disappointed at being unable to find any remnants of a Temple of Diana when he was clearing the foundations of the ruined Old St. Paul's. He may not have

realised that a still earlier cathedral was destroyed by the Great Fire of 1136 A.D.: that the still older church of Miletus was destroyed when the Danes sacked the city in 839 A.D. Moreover as the "Sanctuary" was in St. Martin's he may not have been looking in the right place. Tradition has it that a still older Third Century church preceded that of Miletus, but that St. Martin's was pre-Roman. Again, Sir Christopher Wren was looking for a temple of the Roman period and type, forgetting perhaps that before the Great Fire of Rome, in Nero's reign, the ancient Roman temples were built of wood.⁽³⁶⁵⁾ But he ancient sacredness of St. Paul's district lay not in any building but in the open space. It may quite possibly have been that in Roman London what was called the Temple of Diana was actually a grove of trees within the open space, which certainly seems to have been the case of the famous shrine of Diana at Nemi outside Rome.

Yet another example of the extraordinary continuity of custom in London will be found in the symbolic structure of its civic government. Until the rise of Puritanism, Midsummer Day was celebrated all over Britain. In country places Michael in rustic pageantry still came down from his mount to slay the dragon (see note 176). In London was held the great procession of the Midsummer Watch. Even when this was abolished in Elizabeth I's reign, London's Day with the Lord Mayor's Show was transferred to Michaelmas when the sheriffs were elected.

In the old religion of the Heavenly Twins, the Storm God with his thunderbolt or stone mace, his phallus which became the sword, were accompanied by the twelve Gods of the Mount, and by the Naked Horsemen. When in 1189 A.D. the portreeve of London became the first Mayor, we find the civic government evolved out of the ancient pattern; the Lord Mayor with his mace and sword, his aldermen and his twin sheriffs. To this day, on state occasions at the Guildhall, the mace and swords are laid out in the form of an Andra's Cross.

This symbolic connection with pre-Roman Britain in more complicated detail is clearly to be traced in the actual pageantry of the Midsummer Watch, as held in the Fourteenth, Fifteenth and Sixteenth Centuries. The procession of the Midsummer Watch consisted of several thousand men, but no clergy; it marched from St. Paul's Cross—Old Paulie⁽³⁶⁶⁾—round the city and back to the same point.

In the procession, first came a company of Morris dancers, then twelve "Hobby-horses" and after men in armour followed by

drummers with a very tall canvas giant. After this came three hundred archers and others. Then a band of musicians with fifty naked boys, dyed black like devils, with darts to goad the followers of Pluto. Pluto was a large figure in a decorated cart seated under a canopy. "He himself being naked, with drawn sword in his hand." Clearly in an earlier age this London "Pluto" would have been the Horned God, and gives us an exact parallel to the change of Bacchus into Pluto (see note 341).

Another band of steel-clad halberdiers marched next, preceding the Prophets, with the Tree of Life sprouting from the belly of a recumbent male figure, and by certain mechanisms the Prophets turned about from side to side.

In an earlier time the prophets would have been the Arch-Druids. This is a very strange survival of the prophets who had been so long ousted by the priests.

Then came other marching men and carnival figures preceding choristers on foot in white surplices, in front of a stage on which a very beautiful little girl under a canopy represented the Virgin Mary with four boys chanting Lauds—clearly the Maiden of the Older Cult. Next came a band of halberdiers with a stage on which was St. George in armour, choking a big dragon and delivering St. Margaret.

Then after more soldiers and musicians came twenty-four grave personages—mostly aldermen—all dressed in black velvet with chains of gold and mounted on "small naggies"—a faint memory of the days when only the ass was available for important persons to ride upon. Then in contrast to the solemnity of such equipment and demeanour came the Lord Mayor's two henchmen. They rode upon "great stirring horses" clothed in red, white and gold with huge head-dresses of plumes, some of which stood upright and some which flowed down their backs. Then the sword-bearer carrying the sword of the city preceded the Lord Mayor in crimson damask, and behind the two sheriffs, also on horseback, with crimson surcoats.

The above account from R. Liddesdale Palmer⁽³⁶⁷⁾ is a mixture of periods but it shows how clearly the whole ceremonial was marked with the traditional pattern and colour of the cult of the Heavenly Twins. The Watch moreover was held on the great day of Michael and was purely pagan throughout, with the flower festival of the Stone Age mingled with the bonfires of the Solar Cult and the thousands of lamps from the cult of Diana.⁽³⁶⁸⁾

In 1598 John Stow published an account of how London celebrated Midsummer Day in his time:—

In the evenings after the sun setting there were usually made bonfires in the streets, every man bestowing wood or labour towards them; the wealthier sort also, before their doors near to the said bonfires, would set out tables on the said vigils, furnished with sweet bread and good drink, and on the festival days with meals and drinks plentifully, whereunto they would invite their neighbours and passengers also to sit and be merry with them in great familiarity, praising God for His benefits bestowed on them. They were called bonfires as well of good amnesty amongst neighbours that being before at controversy, were there, by the labour of others, reconciled, and made of bitter enemies, loving friends Every man's door being shadowed with green birch, long fennel, St. John's wort, orpin, white lilies, and such like, garnished upon with garlands of beautiful flowers had also lamps of glass, with oil burning in them all the night; some hung out with branches of iron curiously wrought, containing hundreds of lamps alight all at once which made a goodly show. (369)

It is curious that for nearly a thousand years under the Roman Church Britain held tenaciously to her ancient customs, but with the advent of Protestantism she let the old customs fall into abeyance. Thus in throwing off the political yoke she accepted the spiritual. Little but her national symbols and Orders of Knighthood survived. Of these nothing shows more clearly the continuity of custom than Britannia and her attributes, all of which can be traced back not only to Cappadocia, like St. George, but to that lost civilization in Asia from which the Indo-Europeans first came (see note 262 and 266). Amongst the Phoenicians she was called "the Daughter of the Phoenix," and the Lycaonians of Asia Minor called her Barate. Here the Phoenix, like the Swan, seems to have replaced the goose.

On the Lycaonian coins Barate is depicted as a robed woman seated on a rock or ship amidst waves, and says T. A. Waddell:—

She holds the cornucopia or horn of plenty and beside her chair on board ship is a shield-like Sun Cross, or St. George's Cross within the sun's disc designating her to be of the Solar Cult On the other coins of Cilicia, Lycaonia, Phoenicia, and other Phoenician colonies she sometimes holds a sceptre or standard cross and she sometimes carried a torch which explains the lighthouse figured beside Britannia on the old pennies In the Vedic hymns all the attributes of Britannia are accounted for, her titularship of the waters, her Neptune's trident, her helmet and her shield; her cross on her shield as well as the cornucopia which takes the place of the corn-stalk on the British coins. 369(a)

On some of the coins are stamped the words "The Commonwealth of the Lycaon Barats," showing that even then Britannia was an especial symbol for a Commonwealth of free people. T. A. Waddell also tells us that the Trojan Barate bore the title "Parthenos." She is sometimes represented on early Hittite seals with the weapons of the chase. Thus she became confused with or

identified with Diana. One legend says she sailed west and when she reached Crete she was pursued by the unwelcome attentions of the Minos and escaped by retiring to the sea, sailing to the Island of Aegina, and disappeared there at the spot where now stands the Temple of Diana.

The legend of Barate or Parthenos also throws some light on the underlying symbolism of the Acts of the Apostles. St. Paul came from Tarsus whose original name was "Parthenia." He was connected with Diana of Ephesus;⁽³⁷⁰⁾ he was mistaken for Mercury⁽³⁷¹⁾ (the ruler of the Twins in astrology). Paul like Parthenos "passed through Phoenicia;"⁽³⁷²⁾ and Syria and Cilicia⁽³⁷⁹⁾ and came down to Troy,⁽³⁷⁴⁾ on the way to Macedonia: and so to Athens where he is said to have converted both Dionysus,⁽³⁷⁵⁾ and Apollos.⁽³⁷⁶⁾ Like Parthenos he sailed to Crete and was driven away.⁽³⁷⁷⁾ Moreover he sailed in the good ship, named after the Heavenly Twins, "Castor and Pollux;"⁽³⁷⁸⁾ and so to Rome where there was, beyond the walls, another famous Temple to Diana. Thence, as some authorities declare and others deny, he came to Britain. Whatever be the truth of that, the fact remains that St. Paul not only became the patron saint of London's great shrine to Diana, but the church of St. Paul-without-the-walls at Rome to this day remains, for reasons unexplained, under the unique patronage of the kings of England.

In turn the legend of Diana, Roman in origin, replaced the older Brit or Bride. Britannia is indeed none other than The Great Mother herself, the oldest figure known to mankind. She presided over the seas at the dawn of the agricultural age. She is almost the sole great figure of the past to survive without being Christianised. Surely it would put new heart into efforts in these grim days to realise—once again—that the great symbol of our Mother Country is immortal, for she alone has survived millenia of storm and was already here—in Britain—and hoary with age, before the first legendary dynasties of Sumeria or China.



THE UNICORN
DIVINE

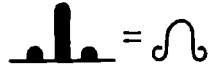

THE LION
HUMAN

HUNTING AGE

THE
HORNED GOD
(THUNDERBOLT)

GREAT MOTHER



PARADISE

COPPER AGE

THE
KING OF HEAVEN
(PHALLUS)

BRITOMART

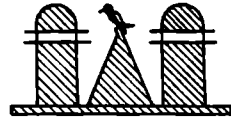

TEMPLE OF ON
KINGDOM OF HEAVEN

CRONOS, INDRA ECT:

BATTLE-AXE

FIRE CROSS

BRONZE AGE

THE
HEAVENLY BRIDEGROOM
(MESSIANIC STONE)

BRIGANTIA

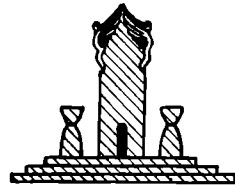

SOLOMON'S TEMPLE

CRONOS AND INDARA IN
CHAINS

INDARA
CROSS

MIKAL
CROSS

IRON AGE

THE
CRUCIFIX
(TOMBSTONE)

BRITANNIA

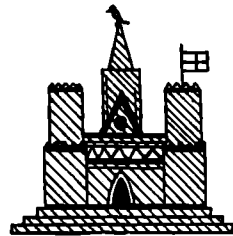

PARADISE LOST

THE CHAINED UNICORN

ANDREW
CROSS

GEORGE
CROSS

AQUARIAN AGE

RESURRECTION
OF THE
DIVINE SON



TREE OF LIFE
(UNCENSORED BIBLE)

PARADISE REGAINED

Country	Tree	Pillar	Gt. Mother	Storm-God	The Twins	Divine Son	Maiden	The Mount	The Bird	The Dog
Egypt	Persea Tree	Pyramid	Lady of Sept.	Set (unicorn)	Shu & Tefnut	Osiris sacrificed & rose again	Isis	Mount of the West 12 Gods	Seb, the Goose God Phoenix	Anush wolfhound
Old Testament	The Oak Allon Most High	Messianic Stone	Eve	El unicorn of Israel	Angels of the Oak Esau & Jacob	The Naked Seer (Man of God)	Virgin of Israel	Mount Zion 12 Tribes	Dove	Caleb K.D.SH (Prophets, Sodomites or dogs)
Phoenician	Oak Ollon	Ashur Elegabe	Barate Gt. Mother	Al Baal	Misor & Sydek Melchizedek	Aleion son of Baal Attis sacrificed & rose again	Daughter of the Phoenix	Mt. Carmel (Mt. Elias)	Phoenix Cock (Persian)	Prophets of Baal
Indian	Banyan Tree Indra's Banner	(Lingam) Indra's Bolt X Cross	Earth-Mother Maya	Indra	Ascevin Twins	Chrishna sacrificed & rose again	Lakmi	Mount Meru 12 sons of Pravati	Goose of Brahma	
Trojan	Oak	Thunderbolt X Cross	Britomart	Indara (Unicorn)	The Naked Horsmen Mikal & Gorgos	The Saviour Oesus	Helen, Daughter of the Sun			
Greek	Oracle	Hermes' Rod	Mother Gi	Cronos (Father Xmas)	The Dioscouri	Thesus Dion-yesus sacrificed became Pluto	Aphrodite	Mount Olympus 12 Gods	Owl of Wisdom (Sophia) Goose = Swan	Hermes the Dog of Zeus
Roman	Jove's Oak sibylline oracle	Jove's Thunderbolt (Phallus)	Juno	Saturn (Saturnalia)	Castor & Pollux	Attis sacrificed & rose again	Venus	Ditto	Goose of Priapus Dove of Venus	THE WOLF
New Testament	The Most High	Peter (Cephas)	Mary	Andrew	James & John The sons of Thunder	The Anointed sacrificed & rose again	The Magdalene	Mount of Transfiguration 12 Apostles	Dove	
Ancient Britain	Oak Be-Alan May Pole	The Holy Stones X Cross	Brit (Bride)	Bel Andra Cerne the one horned	Gog & Magrog Mikal & Gorgos	The High Hesus 7 year sacrifice king of May	Queen of the May	Bel Mount Dinsul (Round Table) Mikal Mount Mt. Camel	Goose of Michaelmas Swan Knight	Alan the Wolfhound
Great Britain	Forbidden Tree of Life	Coronation Stone Andrew X	Britannia	Saint Andrew (unicorn) Father Xmas	Saints Michael & George	Pluto (plutocracy)		Knights of the Garter	Lecturn Weathercock	

CHAPTER 13.

THE RISE AND FALL OF TROJAN BRITAIN.

ONE of the first scientific advances during the last century was in the sphere of geology. At first it roused such bitter hostility all over the country that the geologists were denounced from the pulpits as "dangerous heretics."⁽³⁷⁹⁾ Since then we realise that all the fuss was about nothing because Truth can never in any way injure religion: it can only upset old-fashioned ideas which have become fixed beliefs through lack of adequate knowledge.

In the last fifty years our whole way of life has been revolutionised by the rapidity of the advance of certain sciences, such as mechanics, mathematics, astronomy and physics. It would seem that this advance was due to the fact that nobody, except the specialists concerned, understood what was happening. For that very reason, a general lack of comprehension, the new knowledge slipped past the barriers of intellectual pride and mass opposition. But history, as Hugh Taylor (see note 8) has pointed out, is not yet a science at all, and our whole attitude to history is still dominated by Victorian materialistic conceptions.

H. G. Wells, addressing an International Conference of Teachers chose for his subject:— *The Poison called History* and declared that:—

The adjustment of history to reality has become a matter of supreme urgency. You are teaching history to the oncoming generation in a wrong way and in a wrong spirit. A drastic revision of your ideas and methods is necessary

Nevertheless he spoke to deaf ears, and in the sphere of history we are still up against a blank wall of intellectual obstinacy; which, all unconsciously perhaps, has been conditioning the young minds of Europe to accept war, out of admiration for the dictator.

In nothing is this more clear than in the failure of the historian to recover and rewrite the lost history of Britain, the sole country in the Ancient World that detested war on principle. Centuries ago critical minds found certain errors in our earliest records, and instead of using their critical faculties to sift truth from falsehood, they simply declared the whole of our old chronicles to be sheer fantasy. Exactly the same type of old-world errors were plainly visible in the Bible, but this time it was the critics not the

texts that were suppressed. Thus errors whose correction would have strengthened religion have been allowed to masquerade as truth ; whereas truths which would have acted as a tonic to Britain have been poured down the drain.

The critical attack on British history began in a highly suspicious manner. Until the rise of the Welsh House of Tudor no one in England had any serious doubts that King Lucius founded our national Church about 160 A.D. ; and that the royal succession was established by Brut the Trojan. " The centre of the attack," writes T. D. Kendrick, " centred on the great figure of the Italian, Polydore Vergil." (380)

Now Polydore Vergil was sent to England by the Pope as collector of the Peter's Pence, just about the time when, with the rise of Henry VIII, Rome was in danger of losing that very considerable income. Polydore Vergil's motives therefore for disparaging British history were not those of an historical critic, but in order to undermine Tudor influence. The Tudors claimed direct descent from Arthur and the pre-Roman kings. In other words it was just such propaganda which we now associate with Red Russia.

T. D. Kendrick says that :—" The most withering dismissal of the Trojan origins of the British that had yet appeared " (381) was published by George Lily in 1548. But George Lily was chaplain to that " arch-traitor Cardinal Pole," who in the words of a contemporary

Had moved, excited and stirred diverse great princes to invade this realm of England. (382)

At the same time we are told by T. D. Kendrick that there was a small group of *antiquaries*(?) at Canterbury

With vigorously independent views of the whole matter of Ancient Britain, views that swept Brutus and his Trojans right off the picture. (383)

And, he might have added, views that within a decade or two swept the Spanish Armada up the English Channel with a thousand tons of instruments of torture on board for the better persuasion of Queen Elizabeth I and her followers.

When the Keeper of Antiquities writes :—

The extreme sensitiveness of the British to the Italian's (Polydore's) mild twittering of their traditional history is one of the curiosities of the Tudor period. (384)

One can only hope no future keeper will twit us for objecting to the " mild twitterings " of " Lord Haw Haw," or *Pravda*.

The motives of Nazi propaganda and of Polydore Vergil were identical, namely to undermine British morale and sow internal dissension as a preliminary to armed invasion. But the Sixteenth Century Italian propaganda was so successful that one of the greatest curiosities of all history has been its tame acceptance by generations of our educational leaders. It has proved to be one of the most staggering blows in our long history, one of the type which obliterates memory and so produces symptoms of ill-health that steadily increase with age, unless it can be cured. Not only did it obliterate all knowledge of the immense antiquity of British culture, it also established the apparent primacy of the Roman Church by blotting out all memory of the older British Church. King Lucius, whom the last Abbot of Westminster declared before Parliament in 1555 had founded his Abbey⁽³⁸⁵⁾ "was brusquely expelled from the pages of history by Haddon and Stubbs."⁽³⁸⁶⁾

So successful indeed was this anti-British propaganda that it not only swept away all early British history it also swept Troy itself into the limbo of the waste-paper basket. Not a single important antiquary or historian in Victorian times accepted the historicity of Troy. Troy, they said, was a myth invented by the poetic imagination of Homer. If it had not been for the astonishing persistence of Schliemann in digging up Troy and thrusting its actual remains under their noses there can be little doubt that it would still be regarded as a mere myth.⁽³⁸⁷⁾

Even the *Cambridge Ancient History* speaks of the "Hesus of woad-painted Britain," and whenever Ancient Britain is mentioned on the B.B.C. one never hears a voice that does not use some disparaging expressions that convey the idea of "naked savages." But this idea also only arose during the time when the bitter controversy between Rome and Britain was to end in the dissolution of the monasteries and the Spanish Armada.

The "naked savage" idea arose from the first reports which came back to Europe of the American Red Indians. It was clearly then used as part of the same propaganda campaign for, as T. D. Kendrick writes:—

That the half-naked woad-stained Briton was an important newcomer into the world of the Tudor and Stuart antiquaries, no student of antiquarian thought could possibly deny.⁽³⁸⁸⁾

Yet nothing whatever is done by our educational authorities to counteract this mischievous delusion; a delusion that might, for an

example, have been just what turned the scales of Mussolini's mind when he was hesitating about war or peace with Britain.

Lord Raglan is a typical modern critic of the Ancient British Records, and he writes that :—

The history of Nennius (c.900 A.D.) consists so largely of miracles, anachronisms and other absurdities that it is obviously unworthy to be regarded as an authority for any fact whatsoever.(389)

If a thousand years hence the only surviving record of the Eighteenth Century Europe happened to be *The Scarlet Pimpernel*, and some clever critic happened to discover that it was only a novel, it would be scarcely feasible to argue from that that there had never been a French Revolution. Yet such is precisely the type of reasoning which has scoffed at our early history.

It is a dangerous method of thought because of the indirect damage it is doing to religion. T. A. Waddell, writing on Ancient Britain, points out that :—

The excuse for rejecting these early British Chronicles is one, which if accepted, would sweep away not only the early traditional history of Greece and Rome, which is accepted though resting on mere literary tradition, but also nearly all Old Testament history and much (if not most) of the early Church The difference between the accepted Jewish tradition and the rejected British tradition is that the former is actually taught, as true, by incessant repetition in Church and Sunday school to every one from childhood upwards, whereas the equally well authenticated British tradition is actually disparaged, and stigmatised by modern writers, the one mechanically repeating the other as mere fabricated fables and forgeries despite the facts to the contrary.(390)

There is nothing in the mental sphere more facile than destructive criticism ; but the rôle of constructive critic is far otherwise. Any half-educated mind can succeed at the former, but it requires patience and scholarship to succeed in the latter. If a constructive school of thought had arisen which had examined the early British records with scientific impartiality we might by now have evolved a body of scholarship ready and capable of tackling the necessary and long overdue reform of the Bible. There are many anachronisms, contradictions, etc., in the Biblical text which are becoming obvious to increasing numbers, and therefore a generation is growing up, which having been educated to accept a total rejection of the British chronicles, is, for that very type of thinking, now inclined to a total rejection of the Bible. It was not without reason that Bernard Shaw wrote :—

In plain words, as we cannot get rid of the Bible, it will get rid of us unless we learn to read it *in the proper spirit* which I take to be the spirit of intellectual integrity that obliges honest thinkers to read every line which pretends to divine authority with all their wits about them.(391)

The total rejection of the Bible is now basic to Red Communism. Russian Communism is built up on a purely Victorian and now antiquated, conception of materialism, and its anti-God type of thought is also the result of the type of thought which says a detectable error in detail justifies the rejection of the whole. Surely no one—except the Russians—wants to see the Bible vanish from life like our own history? Yet if it is to be saved from that fate what better first step could be taken than first to learn from our mediæval records how to sift the wheat from the tares ; and how to melt down the dross of mediæval accretions to find the tiny core of pure gold.

T. D. Kendrick, in his recent book (1950) very happily heads a chapter *The Eclipse of British History*. Since an eclipse is a short period of darkness between long periods of light, he evidently expects that, like Troy itself, the long-lost history of Britain will once again shine forth in the light of established fact, and be taught again in all British and American schools.

The following comparison between Ninth Century and Twentieth Century records is suggestive of a first gleam of the returning light. About 1900 B.C. Bronze Age Troy—the Second City—was destroyed, and deserted for several centuries.⁽³⁹²⁾ Now Bronze Age Troy had established trade with Britain (see note 106). These facts have only been known a few years ; they were totally unknown and denied a generation ago.

It is therefore extremely remarkable that the old Welsh records state that Hu the Mighty led the first colony of the Cymri into Britain, from the neighbourhood of Constantinople about 1800 B.C.⁽³⁹³⁾

That this tradition has not a scrap of historical value has long been the almost unanimous opinion of the orthodox learned world for several generations. The statements of these old writers have been spoken of as “preposterous” and “fantastic.” On the other hand, that the imaginative fantasy of the Dark Ages should have guessed back over two thousand, five hundred years into the past and hit an almost exact date to make the statement historically probable is scarcely credible as mere coincidence.

The Second City of Troy reached a high pitch of Bronze Age civilization and then met disaster. It is not a “preposterous” idea that there should have been some survivors, who, faced with the total ruin of their home city and possessing ships capable of long voyages, should have sailed west to seek a new home. If they brought with them to Britain their “trade-secret” of bronze-

making it is not surprising that they were welcomed ; if they also introduced the worship of the White Bull, contemporary with the Cretan Minotaur, it is not surprising that such an event would have passed into our traditional sagas. Moreover, this date co-incides approximately with the dates for the introduction of the Solar Cult into Britain as calculated by Rev. John Griffith (see note 360) and Sir Norman Lockyer, namely between 1900-1700 B.C.

Yet remarkable as one such co-incidence might be the mathematical odds against three must be enormous, especially all coming from different sources. Therefore the traditional dates for the first kings of Ireland and of Britain would seem to warrant less hostile and half-informed scepticism and far more serious research.

About 1400 B.C. the Palace of Knossos and all the other palaces and villas in Crete were destroyed. This is thought to have been the result of an invasion, some account of which has survived in the story of Theseus.⁽³⁹⁴⁾ Here again is a newly established account of a highly civilised and seafaring people suffering from a great disaster ; once again it is not fantastic to suppose there were some refugees. It is certainly remarkable that the Irish give the date of their first king Achaius (Eochaidh Ollamhfodla) as 1383 B.C.⁽³⁹⁵⁾

Thirdly, about 1200 B.C. there was another ferment in the near east.

The power of the Hittites with their iron supplies drew attacks upon them, and about 1200 B.C. their Empire collapsed. The Phrygian city of Hissarlik VI, or Troy, fell before the attacks of the Achaeans. We accept, say Peake and Fleure, the traditional dates 1194-1184 B.C. for the Trojan War, though we note Burn places it at about 1100 B.C.⁽³⁹⁶⁾

Once again a sea-faring people have their home city destroyed ; and once again, from British sources ; Nennius and Geoffrey of Monmouth " guessed " the exact date for the Fall of Troy allowing about ten years for Brut the Trojan to flee from his ruined home and reach safety on the shores of Britain.

There is an explanation as to how so accurate a memory for the dates of the first kings could have survived. We know that the Druid system was based on memory-training. (One survival of the ancient training lasted almost till our own times, and that was the custom of beating the bounds. This yearly ceremony was to impress on the minds of children the exact boundaries of the parish so that they would never forget.) In the old social order a bard must have been something in the nature of a modern university graduate ; a Druid comparable to a Fellow of the Royal Society, for it took twenty years' training for a bard to become a Druid.⁽³⁹⁷⁾

At the time of the Roman invasion it had become compulsory for all conquered and provincial people to acknowledge the Emperor as sole God-on-earth by setting his bust or statue in their temples.⁽³⁹⁸⁾ This attitude to religion outraged the Druids as much as if we had been ordered to place Hitler's bust on the high altars of our churches and chapels. As a result of their refusal to comply they were massacred at Anglesey (see note 435) while, apparently, attempting to escape to Ireland.

Those who survived adopted First Century Christianity and formed the Culdee Church. Ten thousand of these were massacred about 290 A.D. by order of the Emperor Diocletian.⁽³⁹⁹⁾ Yet the story of our early Church is not taught at Sunday school and is not in our history books. In A.D. 314 three British bishops attended the Council of Arles.⁽⁴⁰⁰⁾ Yet we are now taught that Augustine in 597 A.D. was the first archbishop, and we acknowledge this officially by making the bishop of Canterbury primate of All England, instead—if the Church of England were really British—of the (non-existent) Archbishop of Glastonbury.

In 607 A.D. the fortieth or fiftieth archbishop of St. David's with six bishops and the Abbot of Bangor met St. Augustine at Augustine's Oak, and flatly refused to acknowledge the supremacy of Rome.⁽⁴⁰¹⁾ As a result, like the Druids before them, they were massacred at Bangor Abbey by the German army (Saxons) on the order of the Roman bishop. Bangor Library, at that time the finest in the world, was burned.⁽⁴⁰²⁾

The surviving Culdee—Bards were denounced as "heretics" by the Council of Chalons in 616 A.D.⁽⁴⁰³⁾, few escaped with their lives, except those under the protection of a noble family. Their function, in such a family, was to memorise the pedigrees upon which claims to property might rest. With the advent of writing this function ceased and they evolved into the family chaplain. But we can be certain that the very last of the old memory training that would have been forgotten would have been the pedigree of the ancient royal house. Even to-day if some disaster hit our island and destroyed every single written record, almost every family would hand down to its children from memory a rough outline of the Kings of England; many, may be, would not be word perfect, but no one would fail to begin with William the Conqueror, 1066.

Therefore in considering Geoffrey of Monmouth's famous *Historia Regum Britannia* we may safely conclude that, though much of it is invention, at least his *first* king is certain to be accurate. Too many people would have remembered the first king for any

pious monk to bungle on that point ; and moreover the name Brut has a Minoan origin in the Cretan Brit, and the date a comfortable archæological confirmation. Geoffrey's remaining kings might also be fairly accurate up to the Roman invasion. Afterwards the memory schools were scattered and dispersed and there were centuries of unrest and confusion in which only one or two names stand out, like Alfred the Great. Geoffrey's king Arthur, on the other hand, is highly suspect and appears very much like an example of the pious monk Christianising at the orders of Rome what he knew to be the legends of an altogether too highly respected royal title and pagan deity (see notes 156-9).

But Geoffrey most certainly did not "invent" the story of Trojan Britain. Edward the Confessor wrote of London as "a city founded and built after the likeness of Great Troy."⁽⁴⁰⁴⁾ Gildas wrote of New Troy in the Sixth Century, and a thousand years earlier Diodorus Siculus pointed out that British military equipment was of Trojan design.⁽⁴⁰⁵⁾

Indeed, as Helen Waddell wrote : —

This interest in the right way of it at Troy is not merely academic. Not one of the barbarian races but believed they had ancestors in the Great Dispersion. To have fought on the right side at Troy was to have come over with the Conqueror. This tendency was noticed very early and the Normans sat more firmly on the English throne when Geoffrey of Monmouth and Wace traced out their common ancestry with an industry worthy of the College of Heralds.⁽⁴⁰⁶⁾

We may well ask to-day why the Normans and the Tudors were not content to have a Roman pedigree? The answer is that until Polidore Virgil's slow poison began to work a strong belief existed throughout the country, not only that it was more honourable and noble to be descended from the British than the Romans but that the Ancient Britons were of Trojan origin. It took a long time for the subtle Italian propaganda to turn the noble Briton into a naked savage and the cruel and bloodthirsty Roman into the enlightened bringer of civilization.

The Caradoc, the last of the Bronze Age kings of Britain, was the only important prisoner that Rome feared to have publicly flogged and killed in their brutal traditional manner. Why are our children not taught that our captive king stood out a unique and dominating character in the annals of Rome? In his speech before the Roman Senate, as reported by Tacitus, the king said : —

Had my government been directed solely with a view to the preservation of my hereditary domains, or the aggrandisement of my own family, I might long since have entered this city as an ally, not as a prisoner : nor would you have disdained for a friend a king descended from illustrious ancestors, and the dictator of many people.

My present condition stript of my former majesty is as adverse to myself as it is a cause of triumph to you. What then? I was lord of men, horses, wealth: what wonder if at your dictation I refused to resign them. Does it follow, that because the Romans aspire to universal dominion, every nation is to accept the vassalage they would impose? I am now your prisoner, betrayed, not conquered. Had I, like others, yielded without resistance, where would have been the name of the Caradoc? Where your glory? Oblivion would have buried both in the same tomb. Bid me live and I shall survive in history as the sole example of Roman clemency.⁽⁴⁰⁷⁾

Does that sound like the voice of a woad-painted savage pleading for mercy from a public flogging and a cruel death? Who were "the illustrious ancestors"? And note in that remark the stinging sarcasm at the expense of the Imperial Julian House whose founder, the Emperor's grandfather, had been begotten by a serpent in the Groves of Apollo (see note 74). Notice also the outright attack on the totalitarian principles of Rome. Yes, and ask also why his name has been all but forgotten for so long? How did it come about that, for typical example, otherwise learned men like Dr. Briffault should write of the British, contemporary with Cæsar as "aborigines,"⁽⁴⁰⁸⁾ and Mr. Harold Armitage says:—

We may believe that the people of Rome would be eager for information about our remote Islands for, to the Roman, we were his Africa Just as in the year 1890 wealthy people in the luxurious clubs of London might be seen lolling in easy chairs devouring Stanley's *In Darkest Africa*, so in Rome, nearly two thousand years ago inquisitive folk, cultured people, and scholars would have read what had been written by travellers all about the Brigantes and other tribes at that time settled in Britain.⁽⁴⁰⁹⁾

That, in spite of the fact of Cæsar's testimony that the Druids kept their accounts in Greek, that they were known to speak fluent Greek and Latin, like the Caradoc; and that the Gauls sent their sons to be educated in Britain, and their Bards there, for the higher knowledge in order to become Druids.⁽⁴¹⁰⁾ Latin writers had said that the twenty years cycle of training consisted of mathematics, geometry, jurisprudence, medicine, poetry, oratory "and with severe exactitude" natural philosophy and astronomy.⁽⁴¹¹⁾ Mathematics and astronomy were subjects which, from the beginning to end, no Roman was capable of understanding, much less writing about, as their silly system of numerical notation testifies. Anyhow, there were no schools or universities in Rome (see note below 496-497).

These learned disparagers of their own country knew, or should have known, that Diodorus Siculus,⁽⁴¹²⁾ Diogenes Laertius,⁽⁴¹³⁾ Hippolytus,⁽⁴¹⁴⁾ Dion Chrysostom,⁽⁴¹⁵⁾ Ammianus Marcellinus,⁽⁴¹⁶⁾ Pliny⁽⁴¹⁷⁾ and Valerius Maximus⁽⁴¹⁸⁾ were among the

writers who said the Druid system was akin to that of Pythagoras, and that not only was the Pythagorean system one of the most intricate the human mind has yet envisaged, but

Diodorus Siculus, Timagenes, Hypolytus and Clement of Alexandria were unanimous in believing that Pythagoras had received his mystical philosophy from the Celtic priests of Gaul, rather than they from him. Valerius Maximus, in the Second Book of his *Stromata* issues a warning that if one should jeer at the notions of the Druids respecting immortality, he must also laugh at those of Pythagoras.(419)

And further, Pythagoras was intolerant of any kind of blood sacrifice, even an animal, for which reason he was a vegetarian.(420) It is obvious that all these classical writers knew perfectly well that human sacrifice was utterly impossible to a system associated with the name of Pythagoras.(421)

There was never any real doubt about the nature of Roman civilization. It was clearly enough stated by Rome's best known poet, Vergil, who wrote "Let others study Art and Science; Rome has somewhat better to do, namely War and Dominion."(422) The contemporary king of the Picts in Scotland, when he saw the manner in which Rome brought civilization to Britain, declared:—

To robbery, slaughter, plunder, the Romans give the lying name of Empire; they make a solitude and call it peace.(423)

English writers who write of the Ancient Britons, their own forefathers, as aborigines and naked savages, do indeed take on the character of those who listen in war to hostile broadcasts with the deliberate intention of spreading dismay and despondency. History cannot fail to arraign them in company with men like William Joyce and the black traitor Bercius.

It was not an enemy of Rome but a Latin poet who wrote of the great Caradoc, "Rome trembled when she saw the Briton, though fast in chains." Why? Why have we never asked why? It can easily be shown that the statement was literally true.

For the education of the public, in Benn's Sixpenny Edition, Gordon Home writing of the time of the Emperor Claudius said:—

It had recently become clear that the vast province (Britain) that Cæsar had added to the empire had not yet entirely settled down to regarding itself as controlled by the will of the Emperor and Senate of Rome.(424)

Even Moscow could never think out a more incredibly false and misleading statement. Though we, who have been so misled by this passionate worship of Fascism, may not know, every Roman knew that Caesar no more added Britain to the Empire as a province than Hitler did. The Romans all know that he had been

ignominiously defeated, lost his sword, and barely escaped with his life. Indeed the Romans jeered at him in a vulgar lampoon: "To the Britons whom he sought out, he turned his arse."⁽⁴²⁵⁾

On the 13th August, B.C. 29 Augustus Cæsar celebrated the triple triumph which proclaimed the subjection of three continents In the name of the first citizen of the republic he was in reality the undisputed Master of the Roman world; already worshipped as God Incarnate by the Greeks and Orientals, and reigning over Egypt as the legitimate successor of the Pharaohs and above all commanding the sworn allegiance of at least 300,000 soldiers.⁽⁴²⁶⁾

In those days Britons walked the streets of Rome, and British merchants sailed to the Italian ports, the only freemen within the boundaries of the known world. So Horace wrote :—

Nothing but the conquest of Britain was now wanting to make Augustus *presens divus in terris*.⁽⁴²⁷⁾

The fall of Spain, the sack of Carthage, the conquest of Macedonia, the sack of Corinth and capture of Athens, the fall of France, the seizure of the Bosphorus, of Alexandria and Egypt, the fall of Palestine and sack of Jerusalem all had an ominous similarity to our own times and may help us better to understand the Ancient Britons. We spoke of similar events as "the lights going out one by one." Moreover, Augustus—like Hitler—was the first citizen of a Republic.

Then in B.C. 29, goaded by Horace, the whole Empire being at peace, Augustus moved his vast army to Boulogne. But so keen was the memory of the defeat of Julius Caesar that the Emperor hesitated. Horace wrote to him this time a warning that if he too "showed his backside" it would lose him his "throne."⁽⁴²⁸⁾ Scared, the prudent Augustus thereupon secured his retreat by taking off the heavy duties on the import of British goods into the Empire,⁽⁴²⁹⁾ and quietly retired to Rome.

In the year 40 B.C., with the great Empire of 120,000,000 souls still at peace, the Emperor Caligula again mustered a huge Roman army at Boulogne for the invasion of Britain. In modern Europe we have seen men of this type rise to power within the worst of the Nazi concentration camps but not outside it; but when the Fascist system obtains absolute control almost at once they rise to the top (as will be shown in the next chapter). One shudders to think what would have been the fate of Britain if this bloodthirsty monster had landed with a triumphant army. But once again, so great was the fear inspired by Britain's defeat of Julius Caesar that Caligula, having had his fleet burnt, decided that discretion was the better

part of valour. He therefore addressed his soldiers, and using the well-known excusatory phrase of the defeated Julius said :—

Let us, my comrades, leave those British unmolested Behold I wreath for laurel this garland of green-seaweed around my immortal brow, and for *spolia optima* I fill my helm with these smooth and brilliant shells. Decorated with these we will return to Rome and instead of a British king, Neptune shall follow captive behind our triumphal car. To each of you, my fellow soldiers, in this arduous campaign, I promise a gratuity of a year's extra stipend in merited acknowledgment of your services and fidelity to your Emperor. (430)

Once again the mere fear of Britain was sufficient to melt away the entire Roman Army. It was not until a treacherous "Peace Party" arose in Britain and divided the unity of the country that the way was opened up for the armies of the gluttonous and, according to his own family, "half-witted" Claudius (431)

Nought else but treason from the first this land did foyle (Spenser's Fairy Queen).

The Romans came as others would come today, to use the words of the Roman poet, "to impose the custom of peace." (432) This time the British fleet was defeated but, even so, the fear inspired by the defeat of Julius Cæsar was so great when the Roman Army was ordered to embark it mutinied. Envoys had to be sent to Rome to the Emperor, and to quell the mutiny he sent the sly and luxurious eunuch Narcissus. All the weeks that the messengers went to Rome and slowly returned with the eunuch's silken litter the army remained in a state of sulky disobedience. When Narcissus reached Boulogne he mounted the general's tribune and addressed the mutinous soldiers and declared that he himself would lead them. The soldiers were so stung and insulted at being thus addressed by a eunuch that they immediately decided to embark, and so by strange freak of fate the last lamp of the Old World was to be all but extinguished. (433)

Meanwhile, according to the latest orthodox opinion, the Roman landing and advance on London was unopposed. This suggests the work of a treacherous fifth column, for after the betrayal and capture of the Caradoc, the western Clan of the Silures alone "repeatedly put the Romans to rout." (434) It took the Romans about four years to conquer all France, but over eighteen years to advance from the Thames to the Ely-Gloucester line, and nearly forty years to occupy Yorkshire, in spite of sending to Britain, one after another, her greatest generals. Aulus Plautius, who resigned in despair; Geta, who was recalled for failure; Suetonius Paulinus, whose greatest achievement was the massacre

of the elderly and unarmed Druids.⁽⁴³⁵⁾ The failure of Vespasian and Titus is shown by the ferocity of the subsequent sack of Jerusalem. Scapula was also recalled and replaced, first by the engineer Frontinus, and then Agricola, who was also recalled in semi-disgrace.

After the withdrawal of Agricola in A.D. 86, there was no mention of Britain in the Roman records for fifty years. All along, English orthodoxy has been content to ignore the absence of any British records. [It is fair to ask what sort of history would our grandsons have written of the two world wars if they had nothing but Russian records?] There is archæological evidence of the growth of Roman-style towns during those fifty years. The towns, however, were governed by magistrates, not appointed by the Romans but elected by the citizens.⁽⁴³⁶⁾ Hence it would appear that there was a strong "Quisling" or Fascist Party in S. Britain (said to be most Belgæ), but whose co-operation clearly depended on some kind of treaty with the Romans. Indeed, that alone accounts for the Roman fear of putting the captured king of Britain to death in their accustomed brutal manner.

It was not until the reign of Hadrian (A.D. 120)

That Britain was incorporated by treaty, not conquest, with the Roman domains: the Britons retaining their king, laws and rights, and accepting the Roman nucleus of the army for the Defence of the Realm.⁽⁴³⁷⁾

It is noticeable that Hadrian did concentrate on the defence of the north by building his great wall. The wall shows that the Romans knew they were unable to conquer and hold even the lowlands of Scotland, and feared that without such a defence their garrison would not be able to stand up to the Ancient Scots.

That we know nothing whatever of these facts is due in the first place to the fact that:—

During the epoch, when moral degeneracy was obvious and infamous, the Romans invented an ideal past for themselves. To this day schoolboys are made to read passages from Roman poets and prose-authors which confirm those pictures of a noble and primitive people. We may allow, said L. Gurlett the pedagogues to use these extracts provided we do not forget that the truth had quite another aspect.⁽⁴³⁸⁾

In other words it is right to teach the young what you know to be lies, lies which were designed to glorify totalitarian Rome and ridicule democratic Britain. A. D. Howell Smith in his book *In Search of the Real Bible* is even more enlightening when he stated:—

In this field of study as in that of Roman antiquities reactionary critics and archæologists strive to bolster up tradition by loose and

IMMORTAL BRITAIN

inaccurate assertions, and even, in certain cases wilfully distort or suppress the relevant facts.⁽⁴³⁹⁾

Small wonder H. G. Wells spoke of "that poison called history." We have been teaching our children and letting the world believe that our ancestors were a medley of savage tribes which a handful of Roman soldiers overcame, and that what civilization we have inherited from the past we owe to the coming of the "great" Julius Cæsar. Did we not by this glorification of the victorious dictator encourage such minds as those of Kaiser Wilhelm and Hitler to think that what Cæsar did so easily they also could do? Did we not also make it very hard for such minds to understand why we should resist and not welcome the coming of a second Cæsar? Is it not possible that if all down the centuries we had kept the torch of Britain fiercely burning so that those two had known the truth they might, like the great Augustus, have hesitated? There seems little doubt that those historians and archæologists, because of their unconscious but none the less abject worship of totalitarianism in its most malignant form, must bear a very heavy responsibility for the attempted rise of would-be imitators of the Cæsars in the modern world.

It is hard to overestimate the immense price we have had to pay for losing first the "cold war" with Rome, and then again after the victory of 1918. Now it is reported in the Press (December, 1950) that a special panel of professors in Moscow is producing a completely new *History of Britain*.

It is rumoured that it will include the dates when the invention in Russia of the printing press, railway, motor car, aeroplanes, radio and television first came to be known to the awed inhabitants of this Island.⁽⁴⁴⁰⁾

This at least should help us to grasp the real nature of our existing histories of the Roman period. But it is to be noticed that the above paragraph was placed among the comics. That we think it funny means we are so blinded to our danger that we may lose this "cold war" also. No doubt the Roman propaganda, that we were naked savages, seemed just as comic to our ancestors. "Cold war" is not a joke; in some ways it is more deadly than "hot war," for unless we are constantly on our guard against apparently little things we are losing it all the time. Russia's *New History of Britain* is being prepared for *English schools*, presupposing that the Russian invasion will succeed.

But before we can attempt to enlighten others successfully we must first of all educate ourselves into the true nature of "cold war." In the first case Augustus only succeeded in making himself

absolute Fascist dictator by outwardly posing as the first citizen of the Republic. We lost the first "cold war" because all these centuries we accepted and belauded the supposed virtues of that Republic and ignored, by suppression and censorship, the real horrors of the Roman Empire. We lost the 1919 "cold war" because Hitler posed as a socialist, thus deceiving millions. It was not until too late that the real nature of National Socialism became clear and the word Nazi came to take on its real meaning, namely, Fascism. We lost the opening of this present "cold war" because in 1920 or so, very many intellectuals in Europe were completely deceived by the use of the word Communism in Russia. Even now, when the Russians speak of themselves as democratic and ourselves as bloody Imperialists, millions still fail to realise that the word "Communism" in Russian means dictatorship.

Britain is the age-old mother of democracy, but before Immortal Britain can once again illumine the world we ourselves must first learn the density of the blackness in our own minds. Britain cannot become visibly immortal until we ourselves make her so. We must first try to learn to see her through the eyes of our ancestors and not through those of our enemies.

Imagine that as a boy or girl one had stood with one's father on the white cliffs of England in 43 A.D. watching the approach of the Roman fleet. Imagine that later on you had seen your mother raped, your village priest flogged and crucified, your father in slave chains marked to be eaten alive in the Roman circus: and that, as a veteran of many battles, you stood once again on the cliffs this time with your wife in the year 86 A.D. watching the II Aduitrix Legion embarking for their withdrawal to France. Imagine you were then half-naked, your clothes in rags, your hair blowing in the wind for lack of a helmet, your shield bent and battered and only your father's sword intact. Then imagine there flashed back into your mind a picture of your father on those same cliffs forty years before . . . the jingle of his horse's harness, the sun glinting on its beautiful enamel and bronze ornaments, and on the stallion's great gold collar.⁽⁴⁴¹⁾ You recalled your father's golden spurs,⁽⁴⁴²⁾ and the plumes in his gold and jewelled helmet;⁽⁴⁴³⁾ his grandfather's magnificent gold torque; the superb enamelled design on his burnished shield⁽⁴⁴⁴⁾ and the brooch which fastened the spotless five-coloured tartan of his rank.⁽⁴⁴⁵⁾ You would have recalled that your father was not one of the greatest clan chieftains, and would have wondered what had happened to

Queen Boadicea's treasure. (Her estates were worth in millions sterling quite as much as any of the Victorian ducal houses; see note 449). You would have recalled that hers was only one of the great families and that her treasure was not to be compared with the Crown Jewels and the Royal treasure, and you would have wondered in what remote parts of Britain these treasures had been buried.

If there is a life after death I would not care to pass along the ranks of my ancestors if I was one of the learned ones who had suppressed the relevant facts, and so had lauded the Romans at the expense of Britain. Indeed to those who know the facts such scholastic distortion rouses a sense of outrage as if one had witnessed a man throw dung at the Cenotaph or deliberately spit on his mother's coffin as it was being lowered into the grave.

It was thanks to the magnificent defence of our ancestors throughout the stormy years of the first century, against superior military equipment and overwhelming odds, that we today enjoy all our basic freedoms. If in our legal system there were a law of criminal libel to protect the memory of the dead, how many of us would not deserve to stand trial ?

Instead of casually sweeping Nennius's *History of Britain* into the dust-bin we should have acted more honourably, and at least shown some smattering of respect for our gallant dead. Nennius was Abbot of Bangor, a century or so after the massacre there and the destruction of the great library. Instead of scoffing at his work we should have done better to take to heart his reasons for writing it, clearly expressed by himself when he wrote :—

I bore with me an inward wound, and I was indignant that the name of my own people formerly famous and distinguished, should sink into oblivion and like smoke be dissipated. It is better to drink a wholesome draught of TRUTH from a humble vessel than poison mixed with honey from a golden goblet.(446)

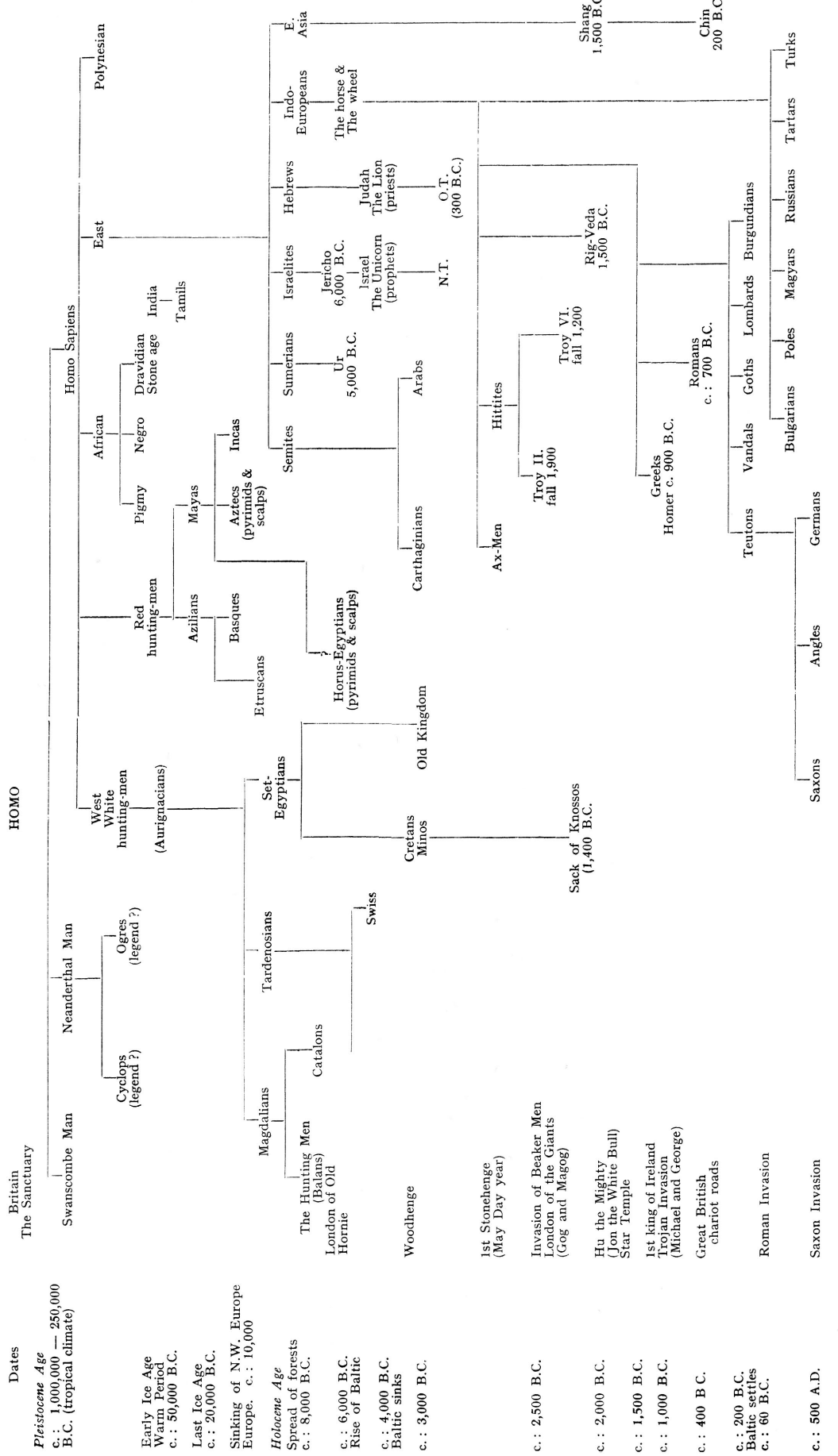

Dates

- Pleistocene Age*
- c. : 1,000,000 — 250,000 B.C. (tropical climate)
- Early Ice Age
- Warm Period
- c. : 50,000 B.C.
- Last Ice Age
- c. : 20,000 B.C.
- Sinking of N.W. Europe
- Europe. c. : 10,000
- Holocene Age*
- Spread of forests
- c. : 8,000 B.C.
- c. : 6,000 B.C.
- Rise of Baltic
- c. : 4,000 B.C.
- Baltic sinks
- c. : 3,000 B.C.
- c. : 2,500 B.C.
- c. : 2,000 B.C.
- c. : 1,500 B.C.
- c. : 1,000 B.C.
- c. : 400 B.C.
- c. : 200 B.C.
- Baltic settles
- c. : 60 B.C.
- c. : 500 A.D.

HOMO

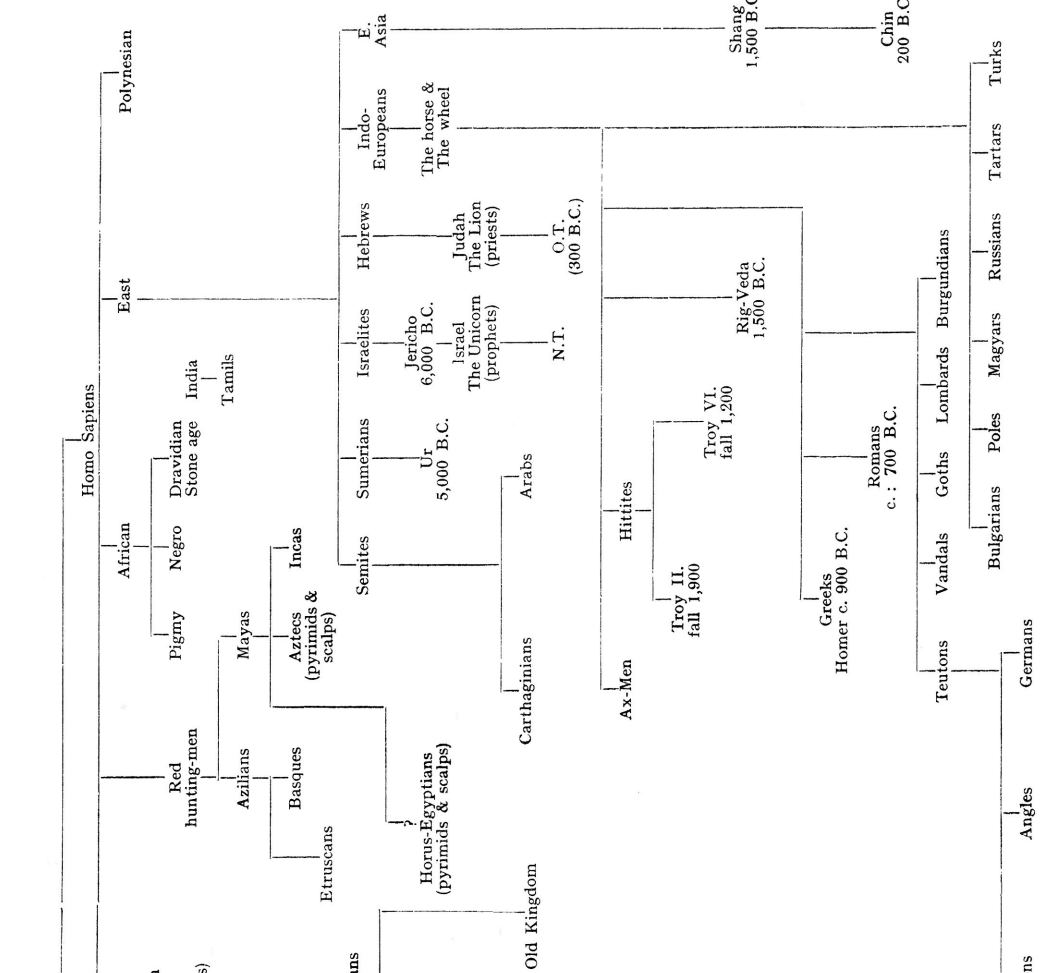

Britain The Sanctuary

- Swanscombe Man
- Neanderthal Man
- Cyclops (legend?)
- Ogres (legend?)
- Magdaliens
- Tardenosians
- The Hunting Men (Buzans)
- London of Old Hornie
- Woodhenge
- 1st Stonehenge (May Day year)
- Invasion of Beaker Men London of the Giants (Gog and Magog)
- Hu the Mighty (Jon the White Bull) Star Temple
- 1st king of Ireland Trojan Invasion (Michael and George)
- Great British chariot roads
- Roman Invasion
- Saxon Invasion

- West White hunting-men (Aurignaciens)
- Red hunting-men
- Pigmy
- Negro
- Dravidian Stone age
- India Tamils
- Azilians
- Basques
- Etruscans
- Horus-Egyptians (pyramids & scapls)
- Carthaginians
- Arabs
- Hitites
- Troy II. fall 1,900
- Troy VI. fall 1,200
- Rig-Veda 1,500 B.C.
- Greeks Homer c. 900 B.C.
- Romans c.: 700 B.C.
- Teutons Vandals Goths Lombards Burgundians
- Bulgarians Poles Magyars Russians Tartars
- Turks
- Cretans Minos
- Old Kingdom
- Sack of Knossos (1,400 B.C.)
- Invasion of Beaker Men London of the Giants (Gog and Magog)
- Hu the Mighty (Jon the White Bull) Star Temple
- 1st king of Ireland Trojan Invasion (Michael and George)
- Great British chariot roads
- Roman Invasion
- Saxon Invasion

CHAPTER 14.

THE ORIGIN OF THE COLD WAR.

THE richness of the archæological remains in Rome is taken as a prime index of a high culture, and the paucity in Britain of a barbarous backwardness. This is a purely materialistic point of view, which ignores the methods whereby Rome acquired wealth, namely plunder and slavery. Generally speaking, it is also a false comparison, for the comparison is made as between pre-Roman Britain and Rome at the height of the Empire; whereas very little has survived of pre-Empire Rome. We only know that its most famous temples on the Capitol were built of wood and thatched.⁽⁴⁴⁷⁾ Had the Rome of that period suffered sixty years of devastating war it is justifiable to wonder how much would have remained for modern archæological discovery.

That seems to be one reason which partly accounts for the scanty pre-Roman remains in Britain. But the principal reason was that we were a free people and had no slaves. Again, a great deal of the archæological evidence from other countries lies in the remains of temples and temple equipment. The British worshipped God in the open air, a circle of stones marking the sacred enclosure. That there are few ruins of temples may be not because the Ancient Britons could not have erected such buildings, but because they disapproved of them on principle. It is obvious that a people who could move Stonehenge from Wales to Salisbury could have built massively had they wanted to. Elsewhere all statuary began as temple furniture—divine images. Might it not be that there were no statues in Britain because the British strongly disapproved of any form of image worship?

Here and there traces of pre-Roman peasant homes have been found but nothing whatever to indicate a large country house. It is possible that this is due to an excessive reverence for Roman mosaic floors, when found. It might have been better—figuratively speaking—to have thrown the wretched mosaics (all found in Britain are of very poor quality) into the sea, and dug down below in search of earlier foundations. Of Royal palaces and public buildings there is not a trace. Consequently we have assumed, and allowed the world and our children to believe, there was no pre-Roman architecture and to think of such buildings as existed in terms of hut-clusters.

Jaquetta Hawkes writes :—

The second great feature of Roman Britain which comes to the mind are the towns Town life was essentially untried in pre-Roman Britain for it has been said, with truth, that the Belgic settlements, even Camulodunum, were not cities but slums.⁽⁴⁴⁸⁾

Such is the picture presented by archæology, but it seems rather an odd conception of truth, when we consider it in relation to our equally scanty literary evidence. After the capture of the Caradoc, the British lost their unity of command. The Romans captured London and advanced to the line Colchester, the Fens near Ely, and from thence across to the Severn. Thus the Icini in Norfolk and Suffolk were completely isolated. They made a separate peace for which they earned contempt as "Quislings." They had to pay a heavy tribute. It was then, when they were more or less helpless, that Seneca, the friend of that "great and noble Roman," the Emperor Nero, lent Boadicea's husband a sum of money—at present day valuation—of roughly three millions sterling, on the security of his public buildings.⁽⁴⁴⁹⁾ Tacitus, accustomed to the enormous private fortunes in Rome at that time spoke of the Suffolk family as immensely wealthy *longâ clarus opulentiâ*. On the death of the king, Seneca and Nero thinking they had only a widow to deal with forced the mortgage with exorbitant interest, and on protest ordered "Caius Decius to take possession of all temples, castles and palaces."⁽⁴⁵⁰⁾

What therefore were these buildings? No mean and clever usurer ever yet lent money to the full value of an estate and, excepting the cathedrals, the public buildings and castles in Norfolk and Suffolk are not, even to-day, worth so very much more. There must have been something there very different from "slums." Moreover, in those days the winters were very severe. Reindeer still lived in Germany and the Rhine froze solid.⁽⁴⁵¹⁾ There must have been stabling somewhere in Britain for thousands of chariots and tens of thousands of army horses. Boadicea had sufficient to defeat Caius Decius and wipe out his army when she advanced south and recaptured London.

Old Japan and the Imperial Forbidden City in Peking provide examples of magnificent wooden structures with comparatively shallow foundations. The older builders always chose the finest sites and in a small country like Britain such sites are seldom if ever permanently abandoned. The deep vaults and dungeons of mediæval buildings required foundations far below those of such wooden buildings. In Aberdeen there are traces of a pre-Roman stone temple (see note 321), and it seems unlikely it

was in any way unique. Southern England from the nature of its geography, climate and proximity to the Continent has always been wealthier than Scotland ; yet when Agricola explored the Firth of Forth with his fleet he did not report "hut-clusters" or even villages, but many towns *amplas civitus*.

Ptolemy who died about 160 A.D. enumerated fifty-six cities in Britain, and it is clear enough that owing to the severity of the fighting nobody could have undertaken any important civic building in Britain until after the treaty with Hadrian in 120 A.D. Also by the treaty the Romans acquired no private property or civil jurisdiction. They provided a military nucleus to a locally recruited army of defence. It is extremely unlikely that they did any civil building in Britain at all, for that was not their function, nor in their character, and we have evidence that about 250 A.D. British architects were in great demand in Europe.⁽⁴⁵²⁾ What seems probable is that Graeco-Roman architectural styles became the fashion and had to be accepted by the architects, and, if we believe the architects and not the pro-Roman archæologists, so far from this constituting an advance in civilization it was a disastrous setback.

James Ferguson in his *History of Architecture* writes:—

The true glory of the Celt in Europe is in his artistic eminence and it is not too much to assert that without his intervention we should not have possessed in modern times a church worthy of admiration, or a picture, or a statue we could look at without shame, and had the Celts not had their arts nipped in the bud by circumstances over which they had no control, we might have seen something that would have shamed even Greece and wholly eclipsed the arts of Rome.⁽⁴⁵³⁾

When we apply the words "town-life was quite untried" to London it at once brings to mind the Sixteenth Protocol of Zion:—

We will erase from the memory of Man all facts which are undesirable to us.

How neatly that fits the case with regard to pre-Roman London ; how clearly that is the intention of Moscow's new history of Britain ! The former shows that the latter is anything but a joke. No matter how preposterous a statement may be, when huge numbers believe it the minority gradually find it more and more difficult to obtain a hearing.

When Boadicea advanced on London a Victorian historian tells us that "in spite of the prayers and tears of the inhabitants"⁽⁴⁵⁴⁾ begging the Roman Commander-in-Chief to stay and protect them ; the "noble" Suetonius Paulinus tried to save the city by

withdrawing, and then the wicked British Queen swept in, burnt down the city and massacred the inhabitants. This the Victorians really believed just because Tacitus said so; but we, in our generation, have (to use a colloquialism) "had some." All too often we have heard that kind of sickening propaganda. It is all too likely that when the Queen reached London she found it a blackened ruin strewn with some twenty or thirty thousand corpses.⁽⁴⁵⁵⁾ Why should the henchmen of Nero and murderer of the aged Druids have spared London? Why on earth should the Queen wish to sack her own city? In revenge, so it is said, because the Londoners had treated with the Romans, but that is precisely what the Iceni had done, when they had free choice and London none.

Moreover, as the dead were estimated in tens of thousands, how could such large numbers possibly have inhabited a site where "town-life was quite untried?" Tacitus indeed not only wrote of London as a great centre of shipping but called it *maxime celebre*.⁽⁴⁵⁶⁾ Also, if London had not been founded until after 50 A.D. Ammianus Marcellinus could not possibly have called it "an ancient city."⁽⁴⁵⁷⁾

Strabo, who died before the Roman invasion, spoke of the abundance of commerce between Britain and the Rhine and the Seine; the exports of corn, cattle, iron and hides, and the imports of brass, ivory and amber.⁽⁴⁵⁸⁾ He also said that about 380 B.C. the explorer Pythias circumnavigated Britain and found the people everywhere, even as far north as Shetland, a settled, peaceful agricultural community.⁽⁴⁵⁹⁾ Over a century earlier, about 500 B.C. the Carthaginian admiral Hanno voyaged round part of Britain and reported trade with Spain and Carthage.⁽⁴⁶⁰⁾ Pliny says that "the whole Roman Empire was supplied with metals from Britannia, and Greece also from the same source as far back as 907 B.C."⁽⁴⁶¹⁾ The Rev. Dr. Poole tells us that Rolin said that

The Phoenicians took purple, scarlet, rich stuffs, tapestry, costly furniture and curious works of art and brought back gold, silver, iron and tin.

Dr. Poole also said that Von Humbert and Sir George Lewis were of opinion that these voyages were of frequent occurrence by 650 B.C.⁽⁴⁶²⁾ Lord Avebury and Sir John Evans said that trade existed as early as 1500 B.C.⁽⁴⁶³⁾ The Abbé de Fontenu proved that the Phoenicians had established trade with Britain before 1190 B.C.;⁽⁴⁶⁴⁾ and modern archæology has confirmed that it began

as early as the second city of Troy (see note 106). Professor Boyd Dawkins described the busy sea-faring population of these Islands in touch with the Mediterranean, with well-known industries in spinning, weaving, pottery, glass-making, bronze and iron as well as the most admirable carpentry and said :—

We get this idea of the pre-Roman dwellers in place of the woad-painted savages of our historians. (465)

Similarly all orthodox historians are agreed that it was the Romans who built London Bridge, in spite of the fact that the Latin poet Martial wrote :—

For mountains, bridges, rivers, temples and fair women Britain is past compare. (466)

Martial lived from about 40 to 104 A.D. Sixty-four battles were fought in Britain between 43 and 86 A.D. During that time both sides were far too heavily engaged in war to build bridges of such fame as to inspire a poet in Rome; but Martial was a Spaniard and therefore not so anti-British as the Romans themselves. Yet such is the extraordinary power of enemy propaganda that it poisons even the most brilliant minds, causing them to turn a blind eye to evidence that refutes such lies, and, as we shall see, to accept avidly wholly unreliable evidence which appears to support them.

It is exactly the same with regard to the great British roads. In the learned world they are universally called Roman roads, and unless we can learn how to fight "cold war" they may one day be called Russian roads! The principal military weapon of the British army was the chariot of Cretan or Trojan design. Only once before, when fighting Antiochus in 192 B.C., had the Roman army encountered the chariot. The formidable Roman army under the tried general Aulus Plautius met the most stubborn resistance in Britain that any Roman army had had to face since the days of Hannibal. This most certainly could not have happened if the British army had not been centrally controlled and equally well led. The whole military strategy of the British army depended upon the swift concentration of chariots at given points. Some 4,000 mustered under the Caradoc. Britain was then a thickly wooded country; the chariots had knife attachments on their wheels so that they could not have travelled over rough open country, they could only have concentrated in one place or another by means of strategically planned roads. These roads radiated from London. W. J. Loftie in his *History of London* says Pre-Roman "London

was of little military importance.⁽⁴⁶⁷⁾ Jacquetta Hawkes compares it to "slums" and yet adds:—

The road centre that radiated from the hub of London was an essential part of Rome's mastery.⁽⁴⁶⁸⁾

What the Romans did was to pave the roads for strategic reasons; (a) a paved road is easier for heavy armed infantry to march on and (b) paved roads became strategically useless to the British because their horses were unshod. But all those writers who endeavoured to correct the grievously erroneous notion that our great roads were of Roman design and construction have received scant mercy at the hands of orthodox critics. It was indeed not without reason that William Blake wrote:—

The strongest poison ever known
Came from Cæsar's laurel crown.

In the following passage from Jacquetta Hawkes we can see the deadly nature of this poison at work.

Little has been said about the Celtic religion. When so much nonsense has been written about the Druids, reacting caution becomes almost excessive. Recently a find has been made which recalls that such bloody and warlike times had a cruel and bloody religion. Anglesea (Mona) was recorded by Tacitus as a great centre of Druidism and there, in a bog, was found a mass of Celtic treasure whose presence in such a remote region was, perhaps, due to a Druid community. Among the chariots, the harness, swords, spears and ornaments which had probably been thrown as offerings into the bog, lay an iron slave-chain with five neck-rings. This, it has been suggested, was used to secure victims, probably prisoners of war who had been selected for the sacrifice.⁽⁴⁶⁹⁾

What is so extraordinary about this passage is the use of the words "reacting caution" followed by as wild a piece of anti-British propaganda as has ever been penned. At the time that Seneca withdrew his huge loan and Boadicea destroyed the army of Caius Decius, Nero ordered his commander-in-chief Suetonius Paulinus to extirpate the Druids at any cost. Paulinus by a rapid forced march surprised a garrison at Anglesea and massacred the Druids. He was then cut off and the Ninth Legion cut to pieces. The defeat of the local garrison is quite sufficient to account for the finds. The idea that the British dropped costly chariots into a bog like peasants dropping pins down a well is "preposterous."

But the archæological inference drawn from the slave-chain passes comprehension; it is so exactly the sort of thing that the Russians are now saying about the Americans in Korea. On account of a slave-chain found amid abandoned military equipment the Druid religion is accounted cruel and bloody, and both

slavery and human sacrifice attributed to them. It is not even suggested that the slave-chain might have been captured from the Romans whose state was a slave-state. It ignores the massive weight of classical evidence (see notes 412—421) that associated Pythagoras with the Druids and so made any kind of blood-sacrifice as out of the question as attributing it to a Buddhist community. Pomponius Mela expressly states that human-sacrifice was forbidden by the Druids.⁽⁴⁷⁰⁾ It also ignores the prime reason of the war between Britain and Rome; namely the resistance of a freedom-loving people against world-domination by Fascist totalitarianism. "In the Ancient world," wrote Geoffrey Higgins,⁽⁴⁷¹⁾ "the Druids were the only priesthood of peace"; [as is confirmed by Diodorus Seculus—the first to call us "savage barbarians"⁽⁴⁷²⁾] which explains the extreme animosity of the Romans to them. The Druidic outlook on slavery and freedom was identical with our own.

Boadicea's speech, as recorded by Dion Cassius, leaves no doubt whatever on this point. All Britain was stung to fury by the massacre of the Druids and flocked to Boadicea's banners. She found herself at the head of a large and angry army, which she addressed in words as stirring as those of Queen Elizabeth I fifteen hundred years later.

I rule not, like Nitocris, over beasts of burden, as are the effeminate nations of the East, nor, like Semiramis, over tradesmen and traffickers; nor like the man-woman Nero over slaves and eunuchs—such is the precious knowledge these foreigners introduce amongst us—but I rule over Britons, little versed in craft or diplomacy, but born and trained to die for their country.⁽⁴⁷³⁾ Men who in the cause of liberty, stake down their lives, the lives of their women and children, their lands and property. Queen of such a Race, I implore their aid for freedom, for victory over enemies infamous for the wantonness of the wrongs they inflict, for their perversion of justice, for their contempt of religion, and for their insatiable greed; a people that revel in unmanly pleasure, whose affections are more to be dreaded and abhorred than their enmity. Never let a foreigner bear rule over me or these, my countrymen; never let slavery reign in this Island.⁽⁴⁷⁴⁾

Notice that the Queen assumes that the common British soldier of that time was acquainted with world-politics. Indeed, had we been led during the Battle of Britain by a widowed Queen, she could hardly have made a better speech nor one that did not express precisely the same sentiments.

On the question of the Druids and human sacrifice there is not a trace of any archaeological evidence to support it; a fact pointed out generations ago by Henry of Huntington.⁽⁴⁷⁵⁾

Because there is no archæological evidence for Trojan London we are told there is no such town. We are told to regard the literary evidence of our ancestors as absurd beliefs, fantastic inventions, and even lies ; but on the other hand with regard to accusing the Druids of human sacrifice we are expected to accept blindly the literary word of hostile Romans.

There is evidence collected by Dr. M. Murray from folklore,⁽⁴⁷⁶⁾ and from fairy-lore by Lewis Spence,⁽⁴⁷⁷⁾ that a *voluntary* victim was sacrificed once every seven years. This custom would have belonged to the archaic May-November year, and clearly, later on, animals were used to replace human victims (see note 361). In times of emergency however, even far into the Christian period there seem to have been occasional revivals. It would have survived in spite of the Druids, not because of them. But this seven-year sacrifice is not what is generally meant when we talk of Druid human sacrifice. That belief arose from the writing of Julius Caesar. Caesar first wrote of public and private sacrifices and then said :—

They use figures of immense size whose limbs woven out of twigs they fill with living men and set it on fire and the men perish in a sheet of flame. They believe that the execution of those who have been caught in the act of theft or robbery or some crime, is more pleasing to the immortal Gods, but when the supply fails they resort to the execution of the innocent.⁽⁴⁷⁸⁾

Yet only a few paragraphs earlier Cæsar had written that

Even for murder their heaviest penalty was banishment from the sacrifices.⁽⁴⁷⁹⁾

We should remember that the Russians probably believe that American baseball and football is a form of blood-sport intended to train young men in the art of killing.

Our historians accept such evidence without question. They ignore the fact that if a people were accustomed to celebrate their festivals in such a gruesome manner for generations, then on every sacred hill would have been found huge piles of burnt bones and skulls. But none has ever been found.

It is curious that the legend of the " noble " Caesar should have had such a hold over the minds of Victorian England. In those days most educated people read Latin and they professed and practised a very rigid form of puritan morality. They were not, like us, largely dependant on translations most of which have been heavily censored.

We have all heard much about the virtues of Cæsar. Let us therefore, in order to evaluate his witness against our ancestors,

consider some of his vices. The information comes not from any sources of anti-Roman propaganda but from his own contemporaries and fellow-countrymen. According to Dolabella, Cicero, Marcus Brutus, the consul Bibulus Curio and the poet Calvus Licinus, Julius Cæsar began his career as a common male-prostitute. His first steps up the social ladder won him the title of "Queen of Bythnia."⁽⁴⁸⁰⁾ How, one wonders, did the Victorians reconcile their furious condemnation of Oscar Wilde with their smug tolerance of a much worse aspect of the same thing in Cæsar?

While still a young man, a lawyer, Cæsar obtained his first important office, that of Pontifex Maximus. This office had hitherto been reserved as a high honour for an elder statesman. Cæsar obtained it by such heavy bribery that on his way to the election he told his mother that if he lost the family would be ruined.⁽⁴⁸¹⁾

Suetonius gives a long list of women seduced by Julius Cæsar. It has become customary to regard this author as a scurrilous gossip—that is when he is not abusing the Britons. But if we consider the anthropological background, and remember that for many generations to seduce the king's wives meant to usurp the throne, it is possible that in Cæsar's day seduction had a more damaging social effect on the injured party than now-a-days. (See note 526.) This would certainly account for the seduction of the wives of his two great rivals Crassus and Pompey, and also explain the saying "Cæsar's wife must be beyond reproach," although he had already divorced one. Similarly, much of his popularity with his army appears due to widespread indulgence with the soldiers, for at his great triumph "for Spain, for Gaul, for Egypt and for Parthia," the soldiers sang: — "He is the husband of every wife in Rome and the wife of every man."⁽⁴⁸²⁾ As Cicero has always been upheld by classical scholars as a model of political integrity, his testimony on this point cannot be dismissed as mere scurrilous abuse. Moreover, such behaviour fits the anthropological pattern of a man in that age aspiring to become a God-King, by demonstrating outstanding sexual potency. Even if modern pedants bent on whitewashing Cæsar declare this to be mere gossip and not fact, what *is* fact is that the Romans started the gossip and for generations believed it. In fine surely Cæsar was not a type British school boys should be taught to admire? Can we wonder that continentals, not understanding the full nature of English puritanical censorship, should call us hypocrites?

Again, Cæsar was one of the few great generals who systematically used the white flag to trap and massacre honourable

enemies. Even the Roman Senate was moved to condemn him on that score.⁽⁴⁸³⁾ He also seduced his army from the service of the State and used it for purely private purposes of self-aggrandisement by marching on Rome. Hardly a quality in a general to be encouraged in democratic countries by upholding Cæsar as a great figure! That his intention in invading Britain was to plunder, rape, loot and transport the people as slaves is invariably overlooked.

Cæsar's cruelty was atrocious. In modern Europe such cruelty only reared its ugly head within the Nazi concentration camps. When Cæsar was courting election for some office such as dictator, we are told by the *Cambridge Ancient History* that:—

To the usual profuseness of the Roman noble, he added unusual abilities as a showman: the gladiatorial games and the beast hunts that he provided during his aediship (B.C.65) were remembered for their sumptuousness and their artistic display.⁽⁴⁸⁴⁾

To the unwary, the above paragraph gives a half-picture of a Royal tournament or circus at Olympia. But it was far otherwise. In all history there is nothing comparable in horror to the Roman games. A sign of our utter lack of comprehension, for which the historians are responsible, is indicated by comedians who often make jokes about being thrown to the lions. They would not dream or dare to make jokes about being skinned alive for lampshades in a Nazi concentration camp. But the Germans at least kept horrors behind barbed wire and made pretence that such incidents were exaggerated. The Romans made these horrors their principal amusement. Tens of thousands of spectators flocked to watch men, women, children and animals killed by every conceivable sexual violence, and bloody and brutal death. Multitudes of prostitutes lodged near the circus to cash in on the high pitch of sexual excitement roused by these "games."⁽⁴⁸⁵⁾ If the gentle and elderly dons, responsible for the *Cambridge Ancient History*, had been compelled to attend one of these games, and when the show was over (if they were still conscious) had cast a last eye over the arena soaked in blood, stinking with human entrails, and scattered with mangled limbs and severed heads; and then had struggled out amidst a swarm of prostitutes and sex maddened audience, would they, one wonders, still have used the expression "artistic display"?

Bernard Shaw in his play *Antony and Cleopatra* which was financed and filmed under the direction of Arthur Rank during the Second World War, made his Briton say: "I would rather be Cæsar's slave than a free Briton." There may have been such

a miserable traitor, even as there may have been an Englishman who preferred to be Hitler's valet, but to make such a character appear as typical of all the British, was as subtle a piece of subversive propaganda as escaped the censor throughout the war. No wonder that Hitler and Mussolini, who were trying to be new Cæsars, were bewildered by the British attitude. When the first Cæsar failed in his invasion of Britain the Britons cried: "*Toni pen Caisar!*" (Off with Cæsar's head!)(⁴⁸⁶) They would not have been in the least surprised when the last of the Cæsars again failed to invade Britain that their descendants should have shouted "Hang the Kaiser!" But we, through a major fault in our education, have lost the continuity of history. While millions were dying in the two World Wars to save democracy from totalitarianism, all the democratic children were being taught that the origin of the totalitarian system in Europe is to be highly commended and admired!

But to return to the question of Druidic human-sacrifice. Let us suppose counsel for the prosecution now rises, demolishes all the arguments put forth above and sways the jury back to the belief that the Druids countenanced private and practised public sacrifice and did burn numbers of people in wicker-giants; and sums up in the words of the *Cambridge Ancient History*:

This gruesome aspect of the Druidic religion horrified the Greeks and the Romans who had forgotten their own barbaric past.(⁴⁸⁷)

Even if this had been so the Ancient Britons were certainly no worse than Christian Europe. We ourselves still practice human sacrifice—by hanging—though we have now ceased to make a public display of it; but in parts of seventeenth century Europe twenty per cent. of the population were burnt alive! Tens of thousands of men, women, children and ministers of religion went up in flames during the paranoic outburst of witch-hunting that lasted several centuries.(⁴⁸⁸) By no stretch of imagination could the pre-Roman Britons have been worse by comparison, so we can see that the peculiar way in which the Ancient Britons were singled out for savage condemnation in this respect was, or is, a form of propaganda designed to bastardise Britain.

But what is meant by the Greeks and the Romans having forgotten their own barbaric past? The Greeks in certain rites of Dionysus actually tore the young Man-God to pieces and ate him alive, and had certainly never forgotten it for it is mentioned by Euripides.(⁴⁸⁹) But here we are primarily concerned with the Romans. Victorian prudery was responsible for picking out from

the classics only those portions thought fit for educational purposes and throwing a thick veil over all they considered improper. Hence an entirely false "white-washed" conception of Rome came to be generally accepted as history. And as a result, during the first half of the Twentieth Century, very few people in the British Commonwealth and America have any real knowledge of the deadly nature of totalitarianism and many no conception of it whatsoever.

Basically it is an epidemic of mass paranoia. Paranoia is the one mental disease which is "highly contagious."⁽⁴⁹⁰⁾ It begins with an inferiority complex and a slight persecution mania, and so leads to aggressiveness. Aggressiveness is, so say the doctors, more dangerous when suppressed than manifest. If and when paranoia progresses there comes a time when the patient feels surrounded by enemies and in his panic strikes out.⁽⁴⁹¹⁾ As a mental disease it follows a specific course of development, and every known revolution in history has developed on identical lines.⁽⁴⁹²⁾ It is particularly clearly seen in the Nazi and Russian Revolutions. When an individual reaches the final violent stage the patient is removed to a padded cell. When such a paranoid, like Hitler, infects a whole nation and then in panic at being surrounded becomes violent and strikes out, it means war. We have to go back to Rome to see what happens when a nation so infected strikes out and triumphs.

The *Cambridge Ancient History* says:—

By an ironic paradox, the two enterprises which brought them (the Romans) so much glory and laid the foundation of their world supremacy had their origins in a groundless fear.⁽⁴⁹³⁾

This clearly is an early paranoid symptom. We have never understood its final horrors and all but became victims a second time, largely because of Victorian prudery.

Judge Stanley Strubbe, at Cincinnati, made a statement that may come to be regarded as one of the most profound ever uttered from the judicial bench when he declared:—

Obscene statutes are shackles on the minds of men which are as bad if not worse than shackles on the limbs of men.⁽⁴⁹⁴⁾

Once the Roman republic came to be infected by a "groundless fear" of enemies its people became motivated by an overwhelming will-to-power.

The Romans came to consider themselves masters of the world by divine right.⁽⁴⁹⁵⁾

To any people whom they intended to enslave they declared that they only came to impose peace (see note 432). Just like Hitler, they talked of a coming age of "eternal peace." Roman law, which also has so often been upheld to the unwary as the

foundation of justice, is described by Otto Keiffer as "that subtly refined modification of the will-to-power."⁽⁴⁹⁶⁾

It is an interesting fact that admirers of Roman law never point out that in Rome only the privileged few, like the members of the Nazi Party, could appeal to the law. The rest, the vast majority, were outside the law and had no criminal or civil rights at all. They could be flogged, raped, tortured and killed at the whim of, what we to-day call, members of *The Party*. They were not even allowed to give evidence in legal trials except under torture and for this purpose the Romans invented all those ingenious instruments of torture which befouled the story of mediæval Europe.

The Romans despised education and sport except only in military training. Such schooling as there was for the upper classes was given by imported Greeks under the open colonnades of the temples. There were no schools. The master had, however, powers of severe chastisement with an extremely nasty variety of flogging instruments, the flogging being carried out under the colonnades, that is in the public street.

All people condemned to death were first publicly flogged. People were summoned to such flogging by a special trumpet.⁽⁴⁹⁷⁾ This applied even to captive kings and generals. Sometimes the condemned were flogged to death, or strangled, or thrown off the Tarpeian Rock,⁽⁴⁹⁸⁾ or buried alive,⁽⁴⁹⁹⁾ or burnt as torches to illumine the Emperor's gardens,⁽⁵⁰⁰⁾ dragged to death by bulls,⁽⁵⁰¹⁾ or sewn into an oxhide sack together with snakes, a cock, a dog or an ape. The "great" Cicero spoke of this last punishment as "outstanding wisdom."⁽⁵⁰²⁾ Worst of all was death on the cross. Once three thousand slaves were nailed on crosses all the way along the road from Rome to Capua. We do not realise that one of the ways the Romans civilized the British was by nailing them on crosses and leaving them to die and rot all along the roads of "England's green and pleasant land." We have forgotten that, in London, Crucifix Lane lies between the Ful-ford and Old Paradise.

But one of the commonest forms of public execution in Rome was for the condemned prisoner to act a rôle in a passion play, or on the stage or in the circus. When we speak of a theatrical tragedy we think of Shakespeare or one of the Greek dramatists; and of an audience moved to tears by the poignancy of the scenes and acting. The Romans had quite other views. Death on their stage had to be real and if possible bloody and prolonged. In staging the play

Prometheus Bound, the chief actor, each time the play was performed, was tied to a rock and eaten alive by a Caledonian bear.⁽⁵⁰³⁾ Recently (1950) a modernised version of *Orpheus and Eurydice* has been translated from the French and put on the London stage. It is almost impossible for us to realise that when this play was staged in Rome the parts of the principal boy and girl were taken by condemned criminals, or slaves bought for the purpose, who died terrible deaths as part of the evening's entertainment; but we shall never understand the real nature of totalitarianism until we realise that such things did happen and could happen again.

To condemn men to fight each other to death and then, maybe, have the throat of the victor slit, to buy men by the dozen for this purpose, to condemn men and women, sometimes with babies at their breast, to be torn to pieces and eaten alive merely to amuse the people, began very early in Republican Rome.⁽⁵⁰⁴⁾ Cæsar bought some three hundred and twenty pairs of gladiators for his "artistic display,"⁽⁵⁰⁵⁾ but with the growth of empire the games came to assume the proportions of a major massacre. It is an example of the "will-to-power" turning in on itself its full destructive force, when there was less outlet for it in war and plunder. In A.D. 107 the games given by Trajan after the conquest of Dacia lasted four months during which time no less than ten thousand men were forced to fight each other to the death.⁽⁵⁰⁶⁾

It was not, however, until "Christianity" became the official religion that the final horrors were added to the ancient legal punishments, i.e. blinding with hot irons, the tearing out of tongues, and pouring into the mouth of the condemned a quantity of molten lead.⁽⁵⁰⁷⁾ Still later, in 320 A.D., Gibbon tells us:—

The horrid practice so familiar to the ancients of exposing or murdering new born infants was becoming everyday more frequent in the provinces and especially in Italy.⁽⁵⁰⁸⁾

What therefore may we ask is the meaning of the sentence that the gruesome aspect of the Druid religion horrified the Romans? In what manner had they forgotten their barbaric past?

The damage the Romans did to humanity in the sexual sphere can scarcely be over estimated. The Roman attitude to sex differed as widely from the Greek as did their conception of drama. To the Greeks beauty was one of the highest expressions of the divine; they saw in male youth the highest beauty and sought to direct it into idealistic channels. To the Greeks idealistic love did not mean "platonic love." That expression did not spring from

Plato but from the Victorians. "Socrates was not an ascetic."⁽⁵⁰⁹⁾ Many accounts of the life of Socrates,⁽⁵¹⁰⁾ and Plato's long description of how as a young man he wooed a somewhat unwilling Socrates,⁽⁵¹¹⁾ make equivocal nonsense of the whole conception of "platonian love" as applied to the Ancient Greeks.

But since we have for so many generations placed homosexual love under a very severe taboo, it is now extremely difficult to realise the vast gulf between Greek and Roman morals. Love, as we understand it, i.e. as between man and woman, played a very minor rôle in classical times. Homosexuality was the dominating factor. On the one hand it was the inspiration which created everything we admire in Greek civilization,⁽⁵¹²⁾ and on the other it produced effects in Rome so evil that we still suffer from the consequences. It was Britain who gave the world the ideal of the love of man and woman.

To the Greek love meant one thing and one thing only, the union of a man and boy which was publically cemented by an elaborate ceremony,⁽⁵¹³⁾ and considered entirely a conjugal union.⁽⁵¹⁴⁾ In law whenever the younger of the pair committed an offence or crime, or screamed in battle, it was the elder who was tried and punished.⁽⁵¹⁵⁾ The lad was expected to kill himself rather than be unfaithful, and many did,⁽⁵¹⁶⁾ so also if the elder was unfaithful and refused him public redress. When Philip of Macedon's boy committed suicide for the above reason the Assembly at Athens immediately awarded him posthumously the highest possible honour, the golden-leaved crown.⁽⁵¹⁷⁾ A man without a young companion was considered to have failed in his duty to the State, and a lad not so honoured to be a public disgrace.⁽⁵¹⁸⁾ Aristotle who was tutor to Alexander the Great described these unions as "one soul in two bodies."⁽⁵¹⁹⁾

Every Greek God from Zeus and Ganymede downwards had their boy lovers, and this primitive ideal reached its apex in the love of Alexander and Hephaestion, which was so intense that when Hephaestion died, Alexander never fought another battle and himself died within the year. Because we regard Alexander as one of the greatest of men and regard homosexuality with extreme distaste, almost every writer on Alexander has tried to remove this "stigma" from him. The usual argument—first put forward by Plutarch—was that he angrily refuses the gift of two Corinthian boys. This argument overlooks the fact that no greater insult could have been offered to an idealistic Greek, and the second

that to have accepted the gift would have been tantamount to signing Hephaestion's death warrant.

It was this conception of an extreme idealism which made love the basic inspiration of Greek civilization. But the great wealth that accrued to the Greeks as the results of the conquests of Alexander the Great corrupted the ancient idealism, so that the boys then became "accomplished coquettes."⁽⁵²⁰⁾ Greek civilization declined from that time; and fell almost without a blow to the Roman invasion, in striking contrast to the Ancient Britons.

Even in the matter of temple prostitution and of the promiscuousness of the rustic festivals the Greeks were animated by a deep religious sentiment. As the *Cambridge Ancient History* points out, unions at such times

Were not mere foul orgies but meant a union with deity (see note 141).

But to the Romans it was far otherwise; theirs was the brutal barrack-room morality of the soldier trained to regard rape and loot as the primary objects of a military life. From the earliest times the Romans were prudes and like all prudes dirty-minded. Their state religion was at once stereotyped and sterilised.⁽⁵²¹⁾ Their homosexual unions were coarse and materialistic. Marriage was instituted so that the ancient matriarchal clan should be deprived of the soldier's loot and of the profits of the first powerful capitalist class in history;⁽⁵²²⁾ and that the plutocrat could leave his wealth to his son or more usually to his catamite, in the manner in which the great Augustus himself inherited the Empire from Julius Cæsar.⁽⁵²³⁾

Only those who can read Latin, or afford to buy expensive translations in Paris, can read Suetonius in full. If his *Lives of the Twelve Cæsars* is libellous in parts, it presents an accurate picture as a whole. Nothing that he said seemed to be in the least incredible to his contemporaries, and his book was widely read. What is of primary importance, in an overall survey, is not the accuracy of each detail so much as what the Romans could, and in very many cases did, believe about their own rulers.

It would require a new Professor Freud to comprehend the kink in the minds of the Victorian classical scholars; to explain how they reconciled on the one hand their belief that the British first received the benefits of civilization from the Romans and on the other their insistence on family prayers and attendance at church or chapel. They knew that republican Rome, as early as the dictator Sulla,

bred and trained many slaves for the sole purpose of the public performance on the stage, and at private entertainments,⁽⁵²⁴⁾ of every conceivable obscenity.

Augustus brought in a number of laws against immorality but these were concerned with marriage, not Roman forms of amusement, and had little effect. We are told by historians (not Gibbon) that Augustus had no homosexual inclinations, but nevertheless earned, through his unchastity, his adoption by his uncle (Cæsar) and after sold himself to Aulus Hirstus.⁽⁵²⁵⁾ "Not even his friends," said Suetonius, "deny that he often committed adultery; but they plead his motives were not lust but policy."⁽⁵²⁶⁾ A remarkable commentary on the brutal Roman attitude to sex.

Augustus was succeeded by the elderly Tiberius—the Emperor responsible for the Crucifixion. Yet in the strange modern mania for white-washing the men whom totalitarianism in its ugliest form pushed to the top, we are now told that what was written about his morals was pure invention. Suetonius and Tacitus, who are praised as sober historians in their descriptions of Britain, are dubbed "malevolent gossips" when they write about their own rulers. We are even told that those who accept these Latin accounts "need not be considered as serious scholars."⁽⁵²⁷⁾ In spite of the many distressing cases in our Law Courts of respectable elderly men who have a breakdown of morals, it is said to be "psychologically impossible" in the case of a Roman Emperor. But we need not consider the accuracy of the detail but rather wonder (a) at the reasons for attempting to induce us to admire the very system we have fought two world wars to prevent recurring, and (b) that the gossip—if gossip it was—was not enemy propaganda and came to be believed by millions in Rome, particularly by the slaves. What actually was said was that Tiberius ordered the sons of the patricians to come and live in his villa at Capri, where he had them instructed by lewd slaves in the performance of group obscenities.⁽⁵²⁸⁾ Amongst these lads were future Emperors and leaders of society and there is nothing whatever in their history to make the idea of such a training in the least improbable. It might even account for the fact that from that time forward that particular type of slave rapidly rose in social importance. Indeed the only way in which a young slave could obtain freedom and wealth was through his sexual attractions and training. This exploitation of sex in all its worst manifestations became the principal road not only socially but to high government office for the next two centuries.

No one has yet attempted to whitewash Caligula. In him we see the worst type of concentration camp commander as absolute ruler of the world. The horrors committed for his amusement have no parallel in history. Claudius was better but he would delay floggings and executions so that he might enjoy the spectacle, while his wife the Empress Messalina with gilded breasts stood nightly for sale in the cheapest brothel.⁽⁵²⁹⁾ An attempt has been made to whitewash Nero by Arthur Weigall, but at the expense of a gross libel on the outraged royal princesses of Britain.⁽⁵³⁰⁾ The boy Sporus who superseded Otho in Nero's graces and whom Nero married in a debased mimicry of Greece was, on Nero's death, made "Queen and Empress" by the Emperor Otho.⁽⁵³¹⁾ Gibbon tells us that :—

The Emperor Vitellus who had been a favourite of Tiberius at Capri consumed in mere eating at least six millions of our money in about seven months. It is not easy to express his vices with dignity or even decency.⁽⁵³²⁾

Marcus Aurelius is usually accounted one of the most enlightened of the Emperors. Nevertheless his wife was in every way as wanton as Messalina and all the sailors and gladiators who became her lovers were raised to posts of honour and profit.⁽⁵³³⁾ Marcus Aurelius also raised his son Commodus to full Imperial honours at the age of fifteen, in spite of what Gibbon calls that boy's "monstrous vices."⁽⁵³⁴⁾ Commodus kept a vast seraglio of hundreds of boy and girl prostitutes, and he raised his favourite, the cruel and debauched slave, Cleander, to the rank of Commander of the Praetorian Guard.⁽⁵³⁵⁾ In A.D. 198 the ex-slave favourite of the Emperor Septimius Severus on the occasion of his daughter's wedding to the future Emperor Caracalla

Castrated one hundred free Romans, some of them married men, and even fathers of families, merely that his daughter might be attended by a train of eunuchs worthy of an eastern princess.⁽⁵³⁶⁾

In A.D. 219, nearly three hundred years after Sulla, the young Emperor Heliogabalus married a slave chariot driver called Hierocles and publicly invested him with the title and authority of the Empress's husband; and thereafter himself signed official documents as the Empress.⁽⁵³⁷⁾ Just before he was murdered he threw the whole Empire into a ferment by announcing that he intended to have all the senators circumcised.

Roman prudery which considered the nakedness of the Greeks at the Olympic Games and in their stadiums to be indecent and effeminate turned into the coarsest channels; so that it came about that in the Roman baths the appearance of a man with a large

member would occasion a round of applause.⁽⁵³⁸⁾ Slaves so endowed began to fetch fabulous prices at the auctions, and finally this actually became a necessary qualification for high government office.⁽⁵³⁹⁾ The Emperor Carinus who filled his palace with singers, dancers and prostitutes, made the possession of extra-sized genitals the sole qualification for promotion. The man who won this singular competition with the tape-measure was made Governor of Rome. He happened to be a doorkeeper—cancellarius—and, as the great Gibbon dryly informs us, it is from this piquant fact that Europe received the word Chancellor.⁽⁵⁴⁰⁾

Meanwhile the vast majority of the inhabitants of the Empire were half-starving freemen or slaves. According to the calculations of Narquart more than half the population of the Empire were slaves, nearly one million in Rome itself.⁽⁵⁴¹⁾ Anything might happen to household slaves, they were entirely at the whim of master or mistress. No doubt there were many quiet households in the Empire, but the threat of torture or a cruel death always hung over their heads. In the mills and galleys they worked seven days a week under appalling conditions and always under the lash. Their lives were without a redeeming feature; from birth to death they were without hope. But they were conscious that their failure to escape their appalling conditions was in some way due to a sexual defect. Hence they became intensely jealous of the small number of their kind whose sex had enabled them to live lives of extreme luxury. Consequently a violent anti-sex reaction set in and with it a belief that it was not this life that mattered but the next.

The abuse had been so appalling that the reaction itself went to an opposite extreme. Much of this reaction overflowed into Christianity and permanently changed its original character. It introduced into the religion of love those qualities of fanaticism, hatred and cruelty that were so marked a feature of social life in the Middle Ages, and which have sprouted new ugly shoots in the Twentieth Century. Indeed, so precarious and violent has life become in our own time that there are some who now speak of "an insane world."

It began as a form of mass paranoia in the Roman Republic creating an overwhelming will-to-power; and when there were no more worlds to conquer turning in on itself with fearful destructive force, first in extreme sexual abuses and then in the virulence of the ascetic revolt against sex. Lindsay in his *History of European Morals* speaks of this ascetic movement as "raging through Europe like a moral epidemic." Sir Gilbert Murray wrote:—

The ascetic movement grew, as we all know, to be measureless and insane. It seemed to be almost another form of lust and to have the same affinities with cruelty. (542)

Canon Charles Raven, Regius Professor of Divinity at Cambridge, writing of St. Jerome, declared that: (on the subject of sex)

He was hardly sane, and the obsession with him, as with his contemporaries infects his whole life and thought. (543)

Consequently much of what the Church Fathers of the Fourth Century taught and which has become Christian moral dogmas binding every man and woman to-day, did not have its origin in Christianity at all, but in Rome. Dr. Robert Briffault giving a medical opinion on this subject, says:—

It is customary to regard those standards as the mature fruit of accumulated human experience, as the temperate conclusions of human wisdom, but it is not so. They are the survivals of what in their original few would hesitate to pronounce as being the fanatical ravings of delirious minds. (544)

Hence much of the sickness of the modern world has its origins in an outbreak of mass-insanity which was the last phase of the Roman will-to-power turning in on itself. When this reaction gained political power and then officially called itself Christianity, the real First-Century Christianity was ruthlessly stamped out. Then the newly born hope in the minds of the slaves, of a better life after death, was cruelly obliterated. It was pictured to them in terms of hell fire even more terrifying than the fearful conditions of their own lives. The road to the after-death-heaven which they longed for was made to seem so incredibly arduous that heaven itself became like the Roman court, a place reserved for the chosen few.

Marriage was no escape, for it was condemned by the Early Fathers in no unmeasured terms.

In the literature of the Apocryphal Acts of the Apostles which issued from the Churches of Asia Minor in the second century, the married life is treated as absolutely unlawful. (545)

The Fathers declared that married persons, or any person having been guilty of sexual intercourse, could not share in the resurrection. (546) Tertullian, in lengthy arguments, insisted that marriage was nothing but fornication, and that captious distinctions drawn between it and adultery were mere legal fictions. (547) St. Jerome said that to marry was the equivalent of "prostituting the members of Christ." (548) St. Ambrose said that

Married people ought to blush at the state in which they were living. (549)

Married men commonly regarded themselves as unworthy of partaking of the sacraments, even as regards baptism, until their wife's

THE ORIGIN OF THE COLD WAR

death, or their own approaching end had placed them in a state of grace.⁽⁵⁵⁰⁾

It was not until the Council of Trent in 1563 A.D. that a religious ceremony was pronounced indispensable for the validity of marriage ; in England not till Lord Harwicke's Act in 1753 was marriage made legal when performed at a religious ceremony.

In the Fourth Century, headed by Origen,⁽⁵⁵¹⁾ thousands seeing no other escape from hell fire castrated themselves. Surgeons were besieged with requests to perform this operation.⁽⁵⁵²⁾ For women no hope appears to have been held out. Women were regarded not as " impure " only, but as the obstacle to purity, the temptress, the enemy. She was " the Gate of Hell,"⁽⁵⁵³⁾ and the " tool of Satan."⁽⁵⁵⁴⁾ " Every woman " says Clement of Alexandria " ought to be filled with shame at the thought that she is a woman."⁽⁵⁵⁵⁾ St. Jerome poured scorn upon motherhood.⁽⁵⁵⁶⁾

We shudder to think to what depths Europe might have sunk if she had not been rescued by the bards of Britain. It was they who created the Age of Chivalry, and the whole concept of " courtly love." In the early middle ages so severe was the ecclesiastical ban on continental singers (see notes 150—153), that " we repeatedly hear of the accomplishments of the singers of Britain, who are specially sent for."⁽⁵⁵⁷⁾ There can be little doubt that the actual life of the knights of the Round Table and of the Holy Grail, and their ladies had been brutalised by successive invasions. It was a rough and violent life without a shred of modesty or decorum, nevertheless it was their singers who rescued women from the degradation of the early fathers and placed around them and their favours, those poetical romances which centuries later blossomed forth into the love of man and woman as we know it today.

It was in order that future generations should never come to understand the facts that the great libraries of Alexandria and Constantinople and Bangor Abbey were destroyed, and Plato's academy in Athens closed. Once again we are reminded of the words

We shall erase from the memory of Man all facts of previous centuries that are undesirable to us.

All those who did not accept Christianity in exactly the form that the Roman State dictated were first deprived of all civil rights and then denounced as " heretics." In the Sixth Century A.D.

the Emperor Justinian ordered one of the most ferocious religious persecutions in history. Throughout the Roman provinces of Asia and Africa tens of thousands had their tongues torn out and were burnt alive.⁽⁵⁵⁸⁾ Writing of this period Dr. Hunter says :—

You will search in vain through the Law of Rome for any trace of reform under Christianity Few people are aware of the ruthless violence with which all dissent from the Church of Rome was stamped out. Before a century had passed under the Christian Emperors the catalogue of Rome's victims was to be reckoned by the hundreds of thousands. In a statute passed in the year 428 A.D. is a list of about thirty sects who were broken up and destroyed by the criminal law.⁽⁵⁵⁹⁾

Again, few people realise that so great was the resentment roused by the Justinian persecution that it resulted in the rise of the Mohammedan power which swept Rome out of Asia, Africa and Spain, and drove her ships off the Mediterranean. In all this holocaust of violence almost all traces of First Century Christianity were lost. Here and there were strange survivals such as the Abyssinian and Coptic Churches. Even the Original Gospel was lost. Irenaeus, who became a disciple of Polycarp, Bishop of Smyrna, and afterwards Bishop of Lyons, wrote in the year 180 A.D. that " Matthew published his Gospel among the Hebrews in his own language."⁽⁵⁶⁰⁾ St. Jerome in the Fourth Century, when he was producing his Vulgate translation of the Bible, wrote that he possessed a copy of the Hebrew Gospel of Matthew which he said " most people declare to be the original one."⁽⁵⁶¹⁾ Since then it has never been seen and indeed not even heard of until the great Quaker scholar Dr. Rendal Harris called it *The Lost Testimony Book*.⁽⁵⁶²⁾ It is possible that the sickness of the modern world is due in part, if not wholly, to the mysterious loss of this gospel. But there can be little or no hope of its recovery until its loss is first recognised ; little or no hope that the light of First Century Christianity can shine into the darkness of this present life until it is realised when and why that light was put out.

There is however a striking parallel between the loss of this gospel and the loss of all early British history. It is noticeable that the veracity of Latin writers may be questioned or even scorned except when they are referring to Britain. When they write of the early Christians in similar terms of contempt great indignation is expressed, so much so that when Pliny wrote :—" We cannot too highly appreciate our debt to the Romans for having put an end to this monstrous cult "⁽⁵⁶³⁾ we cannot tell, without the full

text, whether he was writing of the Christians or the Druids. If he was writing of the Christians we are to feel horrified, but if of the British we are to applaud his wisdom. Yet the very fact that the Romans condemned both in the same type of distortion shows that the two had very much in common. It is extremely hard to understand why professing Christians, particularly those responsible for British Sunday Schools, have totally neglected the traditional teachings of the Druids as they have come down to us in the Welsh Triads. Here all that is best in Christianity, the very apex of Christian idealism, is expressed. How many children are taught throughout the Commonwealth and the United States of America that some of the British Triads are the oldest literature in the oldest living language in Europe ?⁽⁵⁶⁴⁾ Matthew Arnold wrote of them that :—

We may put aside all the vexed questions as to their greater or lesser antiquity, and still what important witness they bear to the genius for literary style of the people who produced them.⁽⁵⁶⁵⁾

They are without any of those contradictions in our existing censored Bible which has caused so much bitter dissention among the churches. The light they throw on the original Christianity allows of no dissention. The finest of them are self-evident truths. Had they been consistently taught down the centuries, there would have been only one British Christianity, not a multitude of anxious conflicting and sometimes self-righteous sects, and it would have been impossible for Blake to have written :

He had only to say God was the devil
and the Devil was God like a Christian civil.

There are many men today to say that our Twentieth Century civilization can only be saved by a change of heart. There will be no change of heart until the British revive the teachings of their ancestors and once again light the torch of Immortal Britain.

To appreciate fully the wisdom of these Triads and why the threefold form was chosen, we should recall the words of Sir Arthur Thompson and Sir Patrick Geddes in their monumental work *Life: an Outline of Biology*.

We suffer all of us from a lack of stereoscopic vision in our mentality Biologists seldom fall down at the fallacy of one-sided vision, for they are always thinking with all three aspects, organisation, environment and functioning plainly in view.⁽⁵⁶⁶⁾

The God-Head they called Duw—the one-without-darkness—who pervaded the universe. Three golden rays of light were the emblem of Druidism, representing the three aspects or persons of the Trinity emanating from the God-Head. They were known as Bel, the Creator as regards the past, Taran, the controlling providence of the present, and Yesu, the coming Saviour of the future.⁽⁵⁶⁷⁾

God, they taught, is one unity whole and indivisible, the sum total of all things containing, and being, the ultimate good, truth and beauty. We, however, have been educated to believe that it was an advance in civilization to fall down and worship the bust of the repellent Claudius !

The three cardinal sins were Pride, Falsehood and Cruelty. Here the wisdom of our forefathers went to the very root of the evil that afflicts modern Europe ; for these are the basic faults of Napoleon, the Kaiser, Hitler, Mussolini and the Supreme Soviet. Our failure to realise the deadly paranoic nature of these faults left us unarmed and unprepared ; because of our ignorance we were led astray when the false prophets, "healed the hurt of my people lightly, saying, Peace, peace ; when there was no peace."⁽⁵⁶⁸⁾ The reason is that the Fourth Century church superseded these three by the solitary doctrine of original sin. Lack of love in the form of sexual frustration encourages the growth of the three cardinal sins. Sin, the Druids taught, is ignorance of the way to live well, and their definition of a good life was one spent in acquiring knowledge.

The three primary virtues were Love, Courage and Truth. A dynamic idealistic teaching in striking contrast to the purely totalitarian concept of Faith, as when it is heresy to question the dictates of the state ; Hope, that the state will fulfill its promises ; and Charity, to accept humbly whatever the state apportions.

The three essentials of good government are Good-will, Free-speech and Knowledge of the matter. If there were any way of putting this maxim into practice there is little doubt that most of the worst abuses of professional politics would be much curbed. The three essentials of good health were Cheerfulness, Temperance and Exercise. The three causes of man falling into *abred* (hell or evil) are neglect of knowledge, aversion to good and love of evil. Three things decrease continually : darkness, falsehood and death. Three things increase continually : light, understanding and life. These three will finally prevail over all ; then *abred* will end.

THE ORIGIN OF THE COLD WAR

When the New Age is at leisure to pronounce, all will be set right, and those grand works of the more ancient, and consciously and professedly inspired men will hold their proper rank, and the Daughters of Memory shall become the Daughters of Inspiration. Shakespere and Milton were both curbed by the general malady and infection from the silly Greek and Roman slaves of the sword.

Rouse up, o young men of the New Age! Set your foreheads against the ignorant hirelings! For we have hirelings in the Camp, the Court, and the University, who would, if they could, for ever depress mental and prolong corporal war.

WILLIAM BLAKE.

Y GWIR YN ERBYN Y BYD
(The Truth against the World).

REFERENCES

CHAPTER I

PROPAGANDA DISGUISED AS HISTORY

1. *Education for a World Adrift*, p.49. Sir Richard Livingston.
2. *Phœnician Origins of the Scots and Britons*. T. A. Waddell, LL.D.
3. *Bartlett's Famous Quotations*.
4. *Twilight of the Gods* (Philosophy and Reason). E. W. Nietzsche.
5. *The Inequality of Man*, p.50. J. B. S. Haldane.
6. *Literary Influences of Academies*, p.56. Matthew Arnold.
7. Article *Evening Standard*, Oct., 1944. Rev. W. R. Inge, C.V.O.
8. *History as Science*, p.10. Hugh Taylor.
9. 288th Anniversary Dinner Royal Society. Presidential address, Professor Adrian.

CHAPTER 2

THE OLD STONE AGE

10. *The Corridors of Time*, vol. ii, pp.18 & 19. H. Peake and H. J. Fleure.
11. *ibid*: vol. ii, p.138.
12. *Early Man in Hallamshire*, pp.61 & 63. Harold Armitage.
13. *ibid*: p.138.
14. *ibid*: p.137.
15. *The Atlantean Continent*, p.10. H. E. Forest.
Atlantis. Pierre Ternier.
The Messenger (1919). Dr. F. Strong.
16. *Salient Points in the Science of the Earth*. Sir William Dawson.
17. *Timæus*, pp.326-328. Plato; trans. H. Davis.
18. *Cambridge Ancient History*, vol. i, p.55.
19. *The Problem of Atlantis*, p.73. Lewis Spence.
20. *Families of Speech*, p.132. Dr. Farrar.
21. *History of London*, vol. i, p.10. W. J. Loftie (1883).
22. *Early Man in Hallamshire*, p.160. Harold Armitage.
cf.: *The Corridors of Time*, vol. iii, p.10.
23. *Mrs. Gaskell: Haunts, Homes and Stories*. Ellis H. Chadwick.
24. *ibid*: p.139.
25. *Early Man in Hallamshire*, p.141. H. Armitage.
26. *Animal Wonderland*, p.189. Frank W. Lane.
27. see note 25, pp.64-65.
28. *Five Stages in Greek Religion*, p.28. Sir Gilbert Murray.
29. *Merry Wives of Windsor*, Act iv, Scene iv.
30. *History of Witchcraft*, p.264. Father Montague Summers.
31. *Phœnician Origins of the Scots and Britons*. T. A. Waddell, LL.D.
32. *Folklore in the British Isles*, p.75. E. Hull.
33. *The History of the Druids*. John Toland.
cf.: *Peter's History of Cornwall and Borlasse's Glossary*.
34. *The Mysteries of Britain*, p.83. Lewis Spence.
35. *Studies in Savages and Sex*, pp.10 & 91. Ernest Crawley and Dr. Theodore Bestermann.
36. *History of Human Marriage*, vol. i, p.81. Dr. Westermarck.
37. *Judges* 11, v. 38.

REFERENCES

38. *Celtic Folklore*. Sir John Rhys.
Folklore in the British Isles, pp.33-34. E. Hull.
39. *ibid*: pp.227-247.
40. *Osiris and the Egyptian Resurrection*, p.285 Sir E. A. Wallis Budge.
41. *Prehistoric History of London*. E. O. Gordon. (Appendix by Rev. John Griffith).
42. Sir Norman Lockyer's date. See *ibid*: p.143.

CHAPTER 4

THE GREAT MOTHER

43. *The Golden Bough*, part iv, bk. i, p.18. Sir James Frazer.
44. *Moses and Monotheism*, p.70. Prof. S. Freud.
45. *Cambridge Ancient History*, vol. iii, p.498.
46. *The Mothers*, vol. i, p.190. Dr. Robert Briffault.
47. *Thierleben*, vol. x, p.35. A. E. Brehm, edit. Otto zur Strassen.
48. *The Romance of the Newfoundland Caribou*, pp.27 sqq. A. R. Dugmore.
49. *Life Histories of Northern Animals*, p.276. E. T. Seton.
50. *ibid*: p.54 ; cf.: *The Mind and Manners of Wild Animals*, pp.229 sqq. W. T. Hernaday.
51. *The Life Histories of African Game Animals*, p.504. T. Roosevelt and E. Heller.
52. *The Mammals of Somaliland*, p.82. R. E. Drake Brockman.
53. *Mammifères de la France*, p.45. P. Marlin.
54. *In the Haunts of Wild Game*, p.301. F. V. Kirby.
55. *Missionary Travels and Researches*, p.547. D. Livingstone.
56. *The Descent of Man*, vol. i, p.74. Charles Darwin.
57. *Thirteen Years among the Wild Beasts of India*, p.51. G. P. Sanderson.
58. *The Corn-King and the Spring Queen*. Naomi Mitchison.
59. *The Mothers*, vol. i, ch. ix. Dr. R. Briffault.
60. *Our Early Ancestors*, p.188. M. C. Burkett.
61. *Early Britain*, p.17. Jacquetta Hawkes.
62. *Le origini della civiltà mediterranea*, p.118. A. Mosso.
cf.: *The Discoveries in Crete*, p.115. R. M. Burrows.
cf.: *The Mycenaean Age*, p.302. C. T. Squantas and J. I. Massatt.
63. *Monumenti Antichi pubblicati per Cura della Reale Accademia dei Lincei*, xix, p.79; plate i, ii. R. Paribeni, from *The Mothers*, vol. i, p.392. Dr. R. Briffault.
64. *Aristotle. Politics*, viii, 6, 2, 3 ; Justin iii, 4 ; Hesychius, cited by Dion Chrysostom, *Orationes* vii, p.273 ; Xenophone *Hellenica* v, iii, 9.
65. Polybius, xii, 6 ; cf.: Plutarch ; *vit. Lycurg.* xv, Xenophon *Republica Lacedæmoniorum* i, 9. *The Mothers*, vol. i, p.693. Dr. R. Briffault.
66. *Theopompus*, cited by Athenæus vi, 20 ; Justin iii, 5 ; Diodorus Siculus vii, i, 21 ; Polybius xii, 5 6.
67. Nicholas Damascenus, in *Fragmenta Historicorum Græcorum*, vol. iii, p.458.
68. Klearch, cited by Athenæus xiii from *The Mothers*, vol. i, p.401.
69. *The Golden Bough*, part iv, bk. i, ch. 4. Sacred Men and Women. Sir James Frazer.
70. Athenæus xii, 14.

REFERENCES

71. *The Cities and Cemeteries of Etruria*, vol. I, p. xiv. G. Dennis. *Etruscan Researches*, p.257. I. Taylor.
72. Cicero, *Rep.*, ii, 18, 33; Dionysus *Halicarnassus* ii, 76; Livy i, 32; Seneca, *Epistol.*, cviii; Ovid, *Fasti* vi, 627; Virgil, *Aeneid*, vi, 816 sq.
73. Plutarch, *Cato Secundus* xxv; Strabo xi, 9.
74. Athenæus I, 303.
75. Republic, v. 7.
76. Diogenes Lærtius vi, 72.
77. *ibid*: viii, 188. *Greek Morality*, p.119. W. H. G. Jones.
78. *The Natural Genesis*, vol. ii, p.169. Gerald Massey.
79. *The High History of the Holy Grail*; trans. Sebastian Evans.
80. *The Religion of the Ancient Celts*, p.73. J. A. MacCulloch.
81. Glossary to Middle English Dialogue of about 1200 A.D. in *Vices and Virtues*; ed. Fred. Hollhausen.
82. *Freemasonry and the Ancient Gods*, p.235. J. S. M. Ward.
83. *The Book of Beginnings*, vol. I, p.184, and vol. ii, p.356. Gerald Massey.
84. *The Arcana of Freemasonry*, p.190. Dr. A. Churchward.
85. *The Religion of the Ancient Celts*, p.63. J. A. MacCulloch. *Le cycle mythologie celtique*, p.155. J. D'Arbois de Jubainville. *Lecture on Celtic Heathendom*, p.89. J. Rhys.
86. Folk-love. K. O'Kearney. *Transactions of the Kilkenny Archæological Society*, ii, p.35.
87. *Zeitschrift für deutsches Alterthum und deutsche Litteratur*, xxxiii, p.284. Prof. H. Zimmer.
88. *L'Art Primitif*, fig. 62, p.110. Prof. G.-H. Luptet.
89. *Pain, Sex and Time*, pp.66 & 189. Gerald Heard.
90. *Conditions of Happiness*, p.273. Gordon Taylor.

CHAPTER 5

FREEDOM AND SLAVERY: A CONTRAST

91. *Stonehenge*, pp.296, 304. Sir Norman Lockyer.
92. *The Axe Age*. T. D. Kendrick.
93. *Ohio State Archæological and Historical Quarterly* 56, No. 2, April 1947. Paul B. Sears.
94. "Pioneer Settlement in the Asiatic Tropics," *American Geographical Society*, New York, 1945.
95. *The Corridors of Time*, vol. iii, pp.12, 13. H. Peake and H. J. Fleure.
96. *ibid*: vol. iv, p.172.
97. *Cambridge Ancient History*, vol. i, p.287.
98. *Cambridge Ancient History*, vol. ii, p.290. *History of Egypt*, vol. ii, p.815. Sir E. A. Wallis Budge.
99. *Notes of the Bacchæ of Euripides*. Sir Gilbert Murray. *Pain, Sex and Time*, ch. viii. ¶ "Greek." Gerald Heard. *Religions of the World*, p.190. Carl Clemen.

CHAPTER 6

THE GROWTH OF CIVILIZATION

100. *The Corridors of Time*, vol. iv, p.171. H. Peake and H. J. Fleure.
101. *Folklore in the Old Testament*, vol. i, p.329. Sir James Frazer.
102. *The Corridors of Time*, vol. iv, p.142. H. Peake and H. J. Fleure.
103. *Our Early Ancestors*, pp.166 & 171. M. C. Burkett.

REFERENCES

104. *Early Man in Hallamshire*, p.292. H. Armitage.
 105. *Aeneid*, bk. v, Virgil.
 106. *The Corridors of Time*, vol. vii, p.158. H. Peake and H. J. Fleure.
 107. *ibid*: vol. vi, p.82.
 108. *Our Early Ancestors*, p.183. M. C. Burkett.
 109. *The Magic Arts in Celtic Britain*, p.40. Lewis Spence.
 110. *The Corridors of Time*, vol. vii, p.32. H. Peake and H. J. Fleure.
 111. *ditto*, vol. vii., p.35.
 112. *Mabinogion*, vol. ii, p.433. Dr. Guest.
Mythology of the British Druids, p.333. Mr. Davies.
 113. *Stonehenge*, p.239. Sir Norman Lockyer.
 114. *The Chronicles of Lanercost*, bk. ii, ch. viii.
 115. *The Mysteries of Britain*, p.165. Lewis Spence.
 116. *The Sexual Life of Ancient Greece*, pp.86-90. Hans Licht.

CHAPTER 7

LIFE IN NEOLITHIC BRITAIN

117. *Early Britain*, p.15. Jacquetta Hawkes.
 118. Arnobius, quoting Varro, *Juvenal Satires*; 9, 12.
The Fairy Tradition in Britain, p.43. Lewis Spence.
 119. *I Kings* 16, v.34.
 120. *The Fairy Tradition in Britain*. Lewis Spence.
 121. cf.: Genesis 20, v. 12, and Genesis 12, vv. 13ff; and Song of Songs, 5, v. 1.
 122. *The Golden Bough*, part iv, bk. i p.31. Sir James Frazer.
 123. *Cambridge Ancient History*, vol. i, p.61.
 124. *The Religion of the Ancient Celts*, pp.222, sq. J. A. MacCulloch.
Chronicles of the Picts, etc., pp.319 sq. W. F. Skene.
La famille celtique, pp.88, sq. H. d'Arbois de Jubainville.
The Ancient Laws of Ireland, pp.208, sq. 206.
The Ancient Laws of Wales, pp.46 and 790.
 125. *The Primitive Family*, etc., p.98. J. A. Todd.
Jesuit Relations and Allied Documents, vol. v, p.220.
Smithsonian Reports, 1863-64, art. F. J. Baegert.
In the South Seas, p.38. R. L. Stevenson.
The Mothers, vol. i, p.131. Dr. Robert Briffault.
 126. *The Sexual Life of the Human Male*, p.219, and fig. 25. Dr. Alfred Kinsey.
 127. *The Life and Times of Hildebrand*. Abbé O. Delare.
 128. Henry of Huntingdon, lib. vii (Matthew, Paris ann 1125). Baronius ann. 1125 A.D. no. 12.
 129. *Epistle John Sarisberen*. 301 Wright, *Poet Songs of England*, p.9.
 130. *Sacerdotal Celibacy*, vol. i, p.319. C. D. Lea, LL.D.
 131. see note 122, p.27.
 132. *Our Early Ancestors*, p.135. M. C. Burkett.
 133. *Love Life in Nature*, p.643. Wilhelm Bölsche.
 134. *Early Man in Hallamshire*, pp.23 and 151. H. Armitage.
 135. *What Happened in History*, pp.50-53. Prof. Gordon Childe.
 136. *The Natural Genesis*, vol. ii, p.125. Gerald Massey.
 137. *Satyricon*, p.137; Petronius. *Natural History*, xv 86; Pliny.
 138. *English Social History in the Making*, p.110. R. Liddesdale.
 139. *The Complete Works of Shakespeare*, edit. Dr. E. Dowden. Index "cock." Hamlet iv, v. Taming of the Shrew iv, i. 2 Henry iv, 1. Merry Wives of Windsor i, i.
 140. I Samuel 10, vv.5-11. I Samuel 19, v.24. 2 Samuel 6, v.20. Isaiah 20, v.3. Micah I, v.8.

REFERENCES

141. *Cambridge Ancient History*, vol. iii, p.451.
 142. Zechariah 14, v.16ff.
 143. cf. Genesis 3 and Revelations 12, v.9.

CHAPTER 8

THE GREAT SANCTUARY OF THE DOMINION

144. *Astrology and Religion*, xv and xvii. Dr. Franz Cumont.
 145. *British Antiquity*, p.6. T. D. Kendrick.
 146. *ibid* : p.93.
 147. *ibid* : p.2.
 148. *The Cultus of St. Peter and St. Paul*, p.75. Rt. Rev. G. E. Browne, D.D.
 149. *Protestantism*, p.13. Rev. W. R. Inge.
 150. *Honorius of Autun. Elucidarium*, in Migne. *Patrologiæ Cursus Completus*, vol. clxxii, col. 1148.
Les épopée en France, vol. ii, pp.65 sq. L. Gautier.
Les jongleurs en France au moyen-âge, pp.24 sqq. E. F. Faral.
 151. *Five Stages in Greek Religion*, p.143. Sir Gilbert Murray.
 152. *Spielmanns-Buch*, p.317. W. Hertz.
Les épopée en France, vol. ii, p.11. L. Gautier.
 153. *The History of Music*, vol. i, p.229. Emil Naumann. Edit. by F. A. Gore-Ormesby, Bart., Mus. Doc.
 154. *ibid* : vol. i, p.221.
 155. *This Present Age*, vol. i, No. 3, p.5. Dr. W. J. Stein.
 156. *Historia Britonum*, pp.47, sqq. Nennius. Edit. by J. Stevenson.
 157. *The Arthurian Material in the Chronicles*, p.29. R. H. Fletcher.
 158. *Annales Cambriae*, in Patris, *Monumenta Historica Britannia*, p.200.
 159. *The Arthurian Material in the Chronicles*, p.101.
The Mothers, vol. iii, p.433 (note). Dr. R. Briffault.
 160. *Glastonbury's Temple of the Stars*, p.51. A. E. Maltwood, pub. John Watkins.
 161. *Air View, Temple of the Stars, Glastonbury*, intro. A. E. Maltwood.
 162. *Le Queste del Saint Graal*, ch. 6 and 8. Trans. W. W. Comfort.
The High History of the Holy Grail, trans. by Dr. S. Evans from *Perceval le Gallois ou le conte du Graal*.
 163. see note 160, p.54.
 164. *History*, ii, 43. Diodorus Siculus ed Didot, p.116.
 165. *ibid* : v.57.
 166. The Plymouth Corporation records the recutting of the Giants in 1494 and their destruction in 1671.
 167. see note 160, p.78.
 168. *Mythology and Ritual of the British Druids*, p.296. E. Davies.
 169. *ibid* : p.301.
 170. see note 161.
 171. "How Games Began," *The Listener*, Aug. 3rd, 1932. H. J. Massingham.
 172. *Mummer's Plays*. R. J. E. Tiddy.
 173. *Dictionary of Faiths and Folklore*. Hazlett. Art : "gule of August."
 174. from *Prehistoric London*, p.121. E. O. Gordon.
 175. *Everyday Book*, vol. i, p.389, from *The Natural Genesis*, vol. i, 347. Gerald Massey.
 176. *History of Oxfordshire*, p.349. Dr. Plott.
 177. *History*, bk.5. Tacitus.
 178. Didot edit of *Plutarch*, vol. 3, p.511.

REFERENCES

179. *The Golden Bough*, part iv, b. i, p.9. Sir James Frazer.
 180. *The Antecedents of Christianity*, p.23. Rev. C. P. R. Rose, B.D., R.N.
 181. *The Gods of the Egyptians*, vol. ii, p.250. Sir E. A. Wallis Budge.
 182. *Cambridge Ancient History*, vol. i, p.232.
 183. *The Gods of the Egyptians*, vol. ii, p.2. ibid.
 184. *Triads of Dynvull Möimud*, ap. Walter, p.315. *Myv; Arch.*, vol. iii. *Ancient Law of Cambria*, ap. Palgrave and Lappenberg.
 185. *Island of Mona*, p.41. A. Llwyd.
 186. *Memorials of Westminster*. Dean Stanley.

CHAPTER 9

MICHAEL'S MOUNT

187. *Encyclopædia of Religion and Ethics* 8, 621-622. R. T. Barnes.
 188. *Greek Saints and their Festivals*, p.27. Dr. M. Hamilton.
 189. *Saints and their Emblems*. M. and W. Drake.
 190. *Black's Guide to the Duchy of Cornwall*, p.37.
Murray's Handbook to Devon and Cornwall, p.102.
 191. *The Mothers*, vol. iii, p.134. Dr. Robert Briffault.
 192. *Phoenician Origins of the Scots and Britons*, pp.259 and 338, T. A. Waddell, LL.D.
 193. *Urgarel*. Notes by Prof. Claude F. A. Schaeffer. See *Illustrated London News*, 14.6.1941.
 194. *The Old Testament in the Jewish Church*, p.37. Prof. Robertson Smith.
 195. Joshua 19, v.33 (A.V.).
 196. Judges 9, v.6.
 197. Judges 9, v.37.
 198. Joshua 24, v.26.
 199. Genesis 14, v.18. cf. Mark 5, v.7 Luke II, v.35. Hebrews 7, v.I.
 200. Joshua 22, v.22.
 201. I Kings 13, v.14.
 202. I Samuel 12, v.18.
 203. I Samuel 9, vv.3 and 20.
 204. Genesis 8.
 205. Judges 13, vv.2 sqq.
 206. *The Golden Bough*, part iv., bk. i, ch. 4. ¶ The Sons of God. Sir James Frazer.
 207. Judges 21, v.21.
 208. I Samuel 13, v.1.
 209. Exodus 24, v.17. Deuteronomy 4, v. 24. Isaiah 10, v.17. Hebrews 12, v.23.
 210. *Oepidus Judiaecus*, p.250. Sir William Drummond. cf. : Elagabal, called Heliogabalus.
 211. Judges I, v.35.
 212. *Phallic Worship*, p.239. George Riley Smith.
 213. *Prospectus for a Dictionary*, p.30. Charles Vallancey, Dublin, 1802.
 214. *The Towers and Temples of Ancient Ireland*, p.334. Keane, Dublin, 1867.
 215. *Murray's Handbook to Devon and Cornwall*, p.6.
 216. *Hastings' Encyclopædia of Religion and Ethics*.
 217. *Le Culte de Priape*, p.5. Sir Richard Payne Knight.
 218. Essay by Dr. R. Biffault in *Sex in Civilization*.
 219. *The Evolution of the Dragon*, p.204. Prof. Sir George Elliott Smith.
 219a. *Sexual Life in Ancient India*, p.158. J. J. Meyer.
 220. *Vocabularia Amatoria*, priv. print, London, 1886.

REFERENCES

221. see note 192. *Phœnician Origine*, p.69.
 222. *Babylonian Writing*, no. 27. G. A. Barton, Leipzig.
 223. *Rogue Herries*, p.198. Hugh Walpole.
 224. *Personal Names of the Kassite Period*. A. T. Clay.
 225. Genesis 26, v.34.
 226. *Iliad*, bk. x, 461. Homer.
 227. *Celtic Folklore*, p.680. Sir John Rhys.
 228. *History of the Druids*. John Toland.
 229. *Britannia*, quoted from *The Book of Beginnings*, vol. i, p.499. Gerald Massey.
 230. Peter's *History of Cornwall*. cf.: *The Wheeled Cross*. R. A. Courtney.
 231. *English Cyclopædia* art : " Fire."
 232. see note 209.
 233. see Intro. *Anti-Claudiensis Alanus de Insulis* (c. 1200 A.D. reprint c. 1600 London Library).
 234. *Secret Doctrine*, vol. i, p.391.
Isis Unveiled, vol. ii, p.211.
 235. *The Book of Beginnings*, vol. i, p.157. Gerald Massey.
 236. Lenoir's *Du Dragon du Metz* from the *Secret Doctrine*, vol. ii, p.102.
 237. *The Gnostics and their Remains*, p.90. C. W. King.
 238. *The Book of Beginnings*, vol. i, p.79. Gerald Massey.
 239. see note 192.
 240. *Five Stages*, p.93. Sir Gilbert Murray.
 241. see note 237, p.44.
 242. *Republic* ii, 375 ff. Plato.
 243. Exodus 13, vv.2 and 12.
 244. Numbers 3, v.16.
 245. *Christian Myth and Ritual*, pp.27-29. Rev. E. O. James.
 246. Isaiah 20, v.3.
 247. Deuteronomy 23, vv.17-18.
 248. *In Search of the Real Bible*, p.23. A. D. Howel Smith.
 249. *ibid* : p.109.
 250. *Antiquita* viii, 13, 3. Josephus after Menander of Ephesus. see *The Mothers*, vol. iii, p.112, note i. Dr. Robert Briffault.
 251. *History*, xi 78, 4. Tacitus.
 252. *Greek Saints and their Festivals*, p.22. Dr. M. Hamilton.
 253. see note 190.
 254. see note 192, p.343 sq.
 255. Daniel 10, v.13.
 255a. *Gods of the Egyptians*, vol. ii, p.258. Sir E. A. Wallis Budge
Book of the Dead xvii, 30.
 256. *De Bello Gallico*, 5.12.6. Julius Cæsar.
 257. *Satyricon*, 136-137. Petronius.
 258. King's *Art of Cookery*.
 259. *The Witchcult of N.W. Europe* appendix IV, p.272. Dr. M. Murray.
 260. *Pat. Lat.* xxxiii, col.185.

CHAPTER 10

THE NAKED HORSEMEN

261. *Boanerges*, p.188. Dr. Rendal Harris.
 262. *Cambridge History of India*, vol. i, p.85.
 263. *Cambridge Ancient History*, vol. viii, p.425.
 264. cf. *Indian Antiquary*. Prof. Webber, trans. by Rev. D. C. Boyde : and *Was the Ramayana copied from Homer*. Kashinath Trimbak (1873).

REFERENCES

265. *Cambridge Ancient History*, vol. i, p.312.
266. *Boanerges*, p.190. Dr. Rendal Harris.
267. *The Cult of the Heavenly Twins*, p.36. Dr. Rendal Harris.
268. *The Mothers*, vol. iii, ch. Holy Matrimony. Dr. Robert Briffault.
269. Genesis 25, v.25.
270. Genesis 25, v.26.
271. *Revue Celtique* vi, pp.179 sqq., "Compert Concobuir."
272. *ibid* : xi, p.12. "La légende de la Conception de Cuchulainn."
L. Duvau.
273. *The Voyage of Bran*, vol. i, pp.44 sqq. K. Meyer and A. Nutt.
274. *The Fians*, pp.16 sqq. J. C. Campbell.
275. *Die irische Helden—und Königsage*, p.629. R. Thurneysen.
276. *Perceval le Gallois*, vol. i, pp.22 sqq. C. Potvin.
277. *Histoire poétique de Charlemagne*, p.378. G. Paris.
278. *Recueil des historiens des Gaules et de la France*, vol. ii, p.546.
M. Bouquet.
279. see note 276, pp.440 sqq.
280. see note 276, pp.227, 439 sqq. (series from *The Mothers*, vol. iii,
p.423. Dr. Robert Briffault.)
281. *Armenians, Koords and Turks*, vol. i, p.154. J. Creagh.
Manners and Customs of the Modern Egyptian, vol. i, p.345.
E. W. Lane.
The Present State of the Empire of Morocco, vol. i, p.187.
L. de Chenier.
282. *The Mystics, Ascetics and Saints of India*, vol. iii, p.138. R. V.
Russel.
Hindu Manners, Customs and Ceremonies, vol., p.118. Father
J. A. Dubois.
283. see note 2.
284. *Boanerges*, p.278. Dr. Rendal Harris.
285. *Greek Saints and their Festivals*. Dr. M. Hamilton.
286. *The Golden Bough*, part iv, bk. I, p.60. Sir James Frazer.
p.336. P. Saintyves.
287. Boniface IV. *De Donat ; Constant*, p.263-9. *Les Saints* (1907),
288. *Boanerges*, pp.201, 302, and *The Cult of the Heavenly Twins*, p.54
Dr. Rendal Harris.
289. *Freemasonry and the Ancient Gods*, p.255. J. S. M. Ward.
290. *Zehen-Jährig Ost-Indianische Reise-Beschreibung*, p.67. J. W. Vogel.
291. *Handbook of American Indians*, vol. i, pp.365 sqq. Art : "cross."
The Mothers, vol. ii, pp.750 sqq. Dr. Robert Briffault.
292. *Encyclopædia Britannica*, art "cross." J. Macall Fallow.
293. *The Mothers*, vol. ii, pp.413 sqq. : *ibid*.
294. *Nat. Hist.*, xxx, 2, 6. : xxxv, 45. Pliny.
295. *Graecia Descriptio* ii, 2, 6 : vii, 26, II : viii, 39, 6. Pausianus.
296. *Hieroglyphics* 36. F. L. Griffith (1898).
297. *Hieroglyphic Dictionary* 318b. W. E. Budge.
298. *Boanerges*, p.200. *ibid*.
299. *ibid* : pp.363 and 376.
300. *Isis and Osiris*, pp.101 sqq. Plutarch.
Fragment xv. Herakleitos.
301. *The Sexual Life of Ancient Rome*, p.114, ¶.3. Otto Kieffer.
302. see note 285.
303. Ed. Gibbon, quoted by T. A. Waddell, see note 2, p.304.

REFERENCES

CHAPTER II

ANDREW AND HIS UNICORN

304. Moor's *Hindu Pantheon*, p.259.
The Gods of India, pp.26 sqq. E. O. Martin.
305. Isaiah 13, v.2.
306. Song of Songs, 2, v.4.
307. *Sexual Life of Ancient India*, p.283. J. J. Meyer.
308. Rig Veda, 4.17.16.
309. *The Gods of India*, p.49. E. O. Martin.
310. Rig Veda, 1.18.17.
311. *The Golden Bough*, part iv, bk. I, ¶ "The Burning of Sandan."
Sir James Frazer.
312. Rig Veda, 3.34.2-4.
313. *Phoenician Origins of the Scots and Britons*, pp.315 sqq. T. A. Waddell.
314. Numbers 23, vv.22 and 24.
315. Rig Veda, 4.22.2.
316. *Boanerges*, p.16. Dr. Rendal Harris.
317. *ibid* : p.392. Evidence from Prof. Frazer of the Forestry Dept., N. Wales and Herr Hess of Giessen.
318. *Freemasonry and the Ancient Gods*, p.236. J. S. M. Ward.
319. *Hutchinson's Spirit of Freemasonry*, p.172, note 8. Ed. by C. Oliver, D.D.
320. *Freemasonry and the Ancient Gods*, p.236. J. S. M. Ward.
321. *Sculptured Stones of Scotland*. J. Stuart, Spalding Club, Aberdeen, 1856.
322. Phoenician origins *ibid* : note 359.
323. *Colloquia Mensalia*, p.232. Martin Luther.
324. *Faiths and Folklore*, p.8. W. C. Hazlett.
325. Phoenician Origins *ibid* note 359.
326. *Bhagavad Gita*, ch. ix.
327. *Cambridge Ancient History*, vol. viii, p.115.
328. *Pagan and Christian Creeds*, pp.202 and 245. Edward Carpenter.
329. *Cambridge Ancient History*, vol. viii, p.449.
330. *ibid* : vol. ix, p.225.
331. *Nat. Hist.*, xx, viii, 39. Pliny.
332. *The Cultus and SS. Peter and Paul*. Rt. Rev. G. F. Browne, D.D.
333. *Monumentia Ecclesiastica*, vol. i, p.169. Benjamin Thorpe.
334. *Folk-lore in the British Isles*, pp.99-100. E. Hull.
335. *The Past in the Present*, pp.158. Dr. Arthur Mitchell.
336. *In the Hebrides*, p.75. A. E. Gordon Cumming.
337. *The Past in the Present*, p.159.
Folk-lore in the British Isles, pp.101-102.

CHAPTER 12

BRITANNIA AND ST. PAUL'S

338. *Bretton Folk*, p.52. H. Blackburn.
339. *Breviary of Britain*. Humphry Lhyud (1570), trans. Thomas Tayne.
340. *Hymni, epigrammata et fragmenta*, Indian, 189. Callimachus.
Hyppolytus, 141. Euripides.
Fabulæ, 182. Gains Julius Hyginus.
Divinarum Institutionum, 1.22.19. Firmianus Lactantius.

REFERENCES

341. *The Mothers*, vol. iii, p.162. Dr. Robert Briffault.
Theogony 909. Hesiod.
Annali del Istituto di corrispondenza archeologica, 1839. H. G. Schültz.
342. *Sexual Life of Ancient Rome*, p.115. Otto Kieffer.
343. *Nat. Hist.* xxviii, 4. Pliny.
344. *The Book of Beginnings*, vol. i, p.469. Gerald Massey.
345. Genesis 31, v.52, and Joshua 24, v.27.
346. *Sex and Sex Worship*, illus., p.344. Dr. C. A. Wall.
The Sacred Fire, p.267. B. Z. Goldberg.
Celtic Druids, p.107. Geoffrey Higgins.
347. Genesis 24, v.2, and 40, v.29.
348. *Nork's Mythologia* i, 154.
349. *Biblical and Semitic Symbolism*, p.7. M. F. Farbridge.
350. Exodus 32, v.15.
351. *Cambridge Ancient History*, vol. ii, p.615.
352. *Gods of the Egyptians*, vol. i, p.148. Sir E. A. Wallis Budge.
353. *Midrash Tellim*, folio 21, col. 2.
354. *Tel-el-Amana a Letters* (w), 183. Berlin, bo. 106, 15 and 16,
355. *Cambridge Ancient History*, vol. i, p.61.
The Golden Bough, part vi, bk. i, p.31. Sir James Frazer.
356. *The Sexual Life of Ancient Greece*, p.125. Hans Licht.
357. *Deipnosophistæ*, xii, 53-56. Athenæus.
358. *The Town of Maiden Castle*, p.67. Eric Benfield.
359. *History in the Making*, p.98. P. Riddlesdale Palmer.
360. *Prehistoric London*, appendix "A," p.150.
361. *The Mysteries of Britain*, p.171. Lewis Spence.
362. *St. Paul's Cathedral and Old City Life*, pp.23 sqq. W. Sparrow Simpson.
363. *Ecclesiastical History*, bk. i, ch. 30. Bede.
364. *Folklore of the British Isles*, p.164. E. Hull.
365. *Faesti*, ad Fest. Roma. Ovid.
366. *History in the Making*, p.106. P. Riddlesdale Palmer.
London Letter Book "H," f.72.
367. *Ibid* : pp.127-129.
London Letter Book "H," 85, f.III.
Cal. State Papers. Venetian, 1520-1526.
368. *The Golden Bough* (opening chapt.). Sir James Frazer.
369. *Survey of London*. John Stow (1598), ed. W. J. Thomas, 1876.
- 369a. see note 2.
370. Acts 19, v.26.
371. Acts 14, v.12.
372. Acts 15, v.3.
373. Acts 15, v.40.
374. Acts 16, v.8.
375. Acts 17, v.34.
376. Acts 18, v.24.
377. Acts 27, vv.12-17.
378. Act 28, v. 11.

CHAPTER 13

THE RISE AND FALL OF TROJAN BRITAIN

379. *The Age of the Earth*, pp.9 and 13. A. Holmes.
380. *British Antiquity*, p.78. T. D. Kendrick.
381. see note 380, p.41.
382. Wriothesley's *Chronicle* sub anno. 1539, ed. W. D. Hamilton.
383. see note 380, p.108.

REFERENCES

384. see note 380, p.84.
 385. *Memorials of Westminster*, " Feb., 1550." Dean Stanley.
 386. see note 380, p.113.
 387. *Troy and Ilium*. H. Schliemann.
 388. see note 380, p.125.
 389. *The Hero*, p.75. Lord Raglan.
 390. *Phœnician Origins*, *ibid* p.147.
 391. *The Black Girl in Search of God*, p.13. G. Bernard Shaw.
 392. *The Corridors of Time*, vol. vi., p.164. H. Peake and H. J. Fleure.
 393. *Celt, Druid and Culdee*, p.48. I. Elder.
 Sharon Turner : *Hist. of Ang.-Sax*, vol. i, ch. ii, p.38.
 note 29. *Traditional Annals of the Cymri*, p.47, triad.4.
 394. see note 392, vol. vii, p.166.
 395. *Manners and Customs*, vol. i, p.244. E. O'Curry.
Diss. on Irish Hist., p.6. C. O'Connor.
 396. see note 392, vol. viii, p.146.
 397. *De Bello Gallico*, VI, 14. Julius Cæsar.
History of the Druids, p.50. John Toland.
 398. *Gibbon's Decline and Fall of the Roman Empire*, vol. i, p.91.
Claudius the God. Robert Graves.
 399. *Celt, Druid and Culdee*, p.104. I. Elder.
Councils and Eccles. Documents, vol. i, 32. Haddon and Stubbs.
Church Hist. of the British, vol. i, p.40. H. Fuller.
 400. *Mansi Conciliorum Nova et ampliss. collectio* ii, p.476 (new edi.).
 Eusebius, *On Socrates*, v.23.
Concilia Complièd (i). J. Crabbe (ii). Lubbé.
 401. *Concilia*, p.108. Sir Henry Spelman.
Laws of England, vol. iv, p.105. Sir William Blackwood.
Annales Cambriæ clvii.
 402. *Ecclesiastical Hist.*, ch. ii, 2. Bede.
Councils and Eccles. Documents, vol. iii, p.38. Haddon and Stubbs.
History of Wales (1911), p.173. Prof. J. E. Lloyd.
History of the Reformation, vol. v. J. H. M. D'Aubigné.
History of Latin Christianity, vol. ii, p.234. Dean Milman.
Annales Cambriæ, clxix.
 403. *The Mysteries of Britain*, p.62. Lewis Spence.
 404. *Prehistoric London*, p.77. E. O. Gordon.
 405. *Biblio : Historica*, bk. v. ch. 8. Diodorus Siculus.
Ancient Laws of Ireland (Senchus Mor), iv, 237.
 406. *The Wandering Scholars*, p.xii. Hellen Waddell.
 407. *Annals* vii, 37. Tacitus.
Annales xi, 10, 11. Johannes Zonara.
 408. *The Mothers*, vol. i, p.765. Dr. Robert Briffault.
 409. *Early Man in Hallamshire*, pp.288-9. Harold Armitage.
 410. *De Bello Gallico*, vi, 14. Julius Cæsar.
 411. *Celt, Druid and Culdee*, p.50. I. Elder.
Geography I, iv, p.197. Strabo.
De Bello Gallico, v. Julius Cæsar.
An Account of Ireland, p.18. E. Champion.
 412. *Histories*, v. 28, 6. Diodorus Siculus.
 413. *Vita*, Intro. 1, 5. Diogenes Laertius.
 414. *Philosophumena* I, 25. Hippolytus.
 415. *Orationes* xlix (Teut. 1919, p.12). Dion Chrysostom.
 416. *Rerum Gestarum Libri* xv, 94. Ammianus Marcellinus.
 417. *Nat. Hist.* xxi, 13. Pliny.
 418. *Memorabilia* ii, 6, 10. Valerius Maximus.
 419. *The Magic Arts in Celtic Britain*, p.11. Lewis Spence.

REFERENCES

420. *Early Greek Philosophy*, p.88. Prof. Burnett.
Legacy of India, p.8. Prof. Rawlinson.
421. *Indian and Western Religious Thought*. A. Radhakrishna.
422. *Aeneid*, bk. v, 851. Virgil.
423. *Vita Agricolae*, xxx. Tacitus.
424. *Roman Britain*. Gordon Home Benn's 6d. Edit.
425. *De Bello ciuli*. Lucan.
426. *Roman Empire*, p.1. G. G. H. Stuart Jones.
427. *Ode* lib. iii, 5. Horace.
428. *Odes* lib. v, 35. Horace.
429. *Geographicus* iv. Strabo.
430. Quoted from *St. Paul in Britain*, p.84. Rev. R. W. Morgan.
431. *Lives of the Cæsars*, Claudius 4 (letters of Augustus to Livia).
432. see note 422.
433. see note 430.
434. *Annals* v, c.28. Tacitus.
435. *Annals* xii-xxx and *Vita Agricola* 5, v.18. Tacitus.
436. *An Introduction to the History of England* (1949), pp.137 & 140.
 Douglas Jerrold.
437. *Vita Hadriani* ch. 6. Spartian.
Celt, Druid and Culdee, p.41. I. Elder.
438. *Eritica Plautina*, p.15. L. Gurlett.
439. *In Search of the Real Bible*, p.105. A. D. Howel Smith.
440. *Everybody's*, Dec. 16, 1950.
441. see breast plate for a horse, Brit. Museum.
442. found at Kylo, Northumberland, with gold sword and sword
 harness, mentioned by John Leyland (c. 1530). *British
 Antiquities*, p.55. T. D. Kendrick.
443. *ibid* : found at Harlaxton, Lincs.
444. see Witham and Battersea shields in Brit. Museum.
445. *Anglo-Saxon Art platea* 1, i, and 3, ii. T. D. Kendrick.
445. *Celt, Druid and Culdee*, p.31. I. Elder.
Xiphilinus Excerpta, bk. iv, ch. iv, 3. Dion Cassius.
446. *Martial Epigrams* lib. 1, 32, and lib. iii, 20. "British wool is
 past compare." The only existant piece in the Copenhagen
 Museum is of the quality of modern Harris tweed.
446. *History of the Britons*, prol., p.2. Nennius, trans. J. A. Giles.

CHAPTER 14

THE ORIGIN OF THE COLD WAR

447. *Fasti ad Fat*. Roma. Ovid.
448. *Early Britain*, p.39. Jacquetta Hawkes.
449. *Xiphilinus Excerpta*. Dion Cassius.
Celt, Druid and Culdee, p.36. I. Elder.
450. *Annals* xiv, 31. Tacitus.
451. *De Bello Gallico*, 6 and 3. Julius Cæsar.
452. *Panegyric Britannia*, c.ii. Eumenius.
453. *History of Architecture*, p.73. James Fergusson.
454. *History of London*, vol. 1, p.59. W. J. Loftie.
455. *ibid*.
456. *Annals* xiv, c.27-30. Tacitus.
457. *Libri* xxvii, c.8, 9. Ammanianus Marcellinus.
458. *Geographicus* iii, 175 ; and iv, 199. Strabo.
459. *ibid*, iv, 55.
460. *Ora Maritima* 110. R. Festus Avienus.

REFERENCES

461. quoted from *Anglo Saxons are Israelites*, p.36. Rev. W. H. Poole, D.D.
462. *ibid.*
463. *Did Our Lord Visit Britain ?* p.16. Rev. C. C. Dobson.
464. *Mem. de Littérature* tome vii, p.12. Abbé de Fontenu.
465. quoted from *Prehistoric London*, p.54. E. O. Gordon (reference not given).
466. *Epigram* xi, 54. Martial.
467. see 454, vol. i, p.29.
468. *Early Britain*, p.38. Jacquetta Hawkes.
469. *ibid.*, p. 36.
470. Quoted from *Magic Arts in Celtic Britain*, p.47. Lewis Spence.
471. *Celtic Researches*, p.196. Geoffrey Higgins.
472. *Histories*, bk. v. 286. Diodorus Siculus.
473. The actual Latin text says "for the game of war"; that seems like a Latin misunderstanding for it is directly contrary to Druidic teaching which did teach the duty of dying for one's country when attacked.
474. *Xiphilinus Excerpta* ad, an, 58, 59. Dion Cassius.
475. *Historia Anglorum* Lib. iii, Henry of Huntington. apud res Anglie Script, p.322. Ed. Saville.
476. *The Witch Cult in Western Europe*. Dr. M. Murray. *The God of the Witches*. Dr. M. Murray.
477. *The Fairy Tradition in Britain*. Lewis Spence.
478. *De Bello Gallico*, vi, 16. Julius Cæsar.
479. *ibid.*: vi, 13.
480. *Verres* xi, 78, 192. Cicero. *Lives of the Cæsars*, Julius lii and vlix. Suetonius. *Poems* 29 and 57. Catullus. *Poems*. Calvus Licinus.
481. *Cambridge Ancient History*, vol. ix, p.488.
482. *Verres* II, 78, 192. Cicero. *Poems*, 57. Catullus.
483. *Cambridge Ancient History*, vol. ix, pp.556-559.
484. *ibid.* : vol. ix, p.482.
485. *History of Syphillis*, pp.111 sqq. Dr. Rosebaum.
486. *Noctes Atticae*. Aulus Gellius (A.D.130).
487. *Cambridge Ancient History*, vol. ix, p.544.
488. *Witchcraft and the Black Art*. J. W. Wickwar.
489. see note 99.
490. *Peace and War*. William Browne, M.D., D.Sc.
491. *The Modern Treatment of Nervous Diseases*, pp.620 sqq. W. H. White and S. F. Jeleffe.
492. *Farewell to Revolution*. Dr. Everett Dean Martin.
493. *Cambridge Ancient History*, vol. viii, p.239.
494. *Los Angeles Times*, June 11, 1948.
495. *Sexual Life in Ancient Rome*, p.65. Otto Kieffer.
496. *ibid.* : p.67.
497. *Controversiae* ix, 10. Seneca.
498. *Libris* xxiv, 20. Livy.
499. Cornelia the Vestal Virgin, by Domitian.
500. *Annals*. Tacitus.
501. *Epistle to Corinthians I*, vi, 1, 2. Clement of Rome.
502. *Pro Roscio Amerino*, 25. Cicero.
503. *Liber Spectaculorum* 7. Martial.
504. *Memorabilia*, ii, 4, 7. Valerius Maximus. *Libri* xxiii, 30 ; xxxi, 50. Livy.

REFERENCES

505. *Lives*, "Cæsar" 5. Plutarch.
 506. *Historia Romana*, 68, 15. Dion Cassius.
 507. *Decline and Fall*, vol. i, p.514. Gibbon. Bohn's Library, 1891.
 508. *ibid* : vol. i, p.512.
 509. *Cambridge Ancient History*, vol. v, p.387.
 510. *Memorabilia* I, 3, 12, ii, 6, 28. Xenophon.
De Abstemientia, 201. Porphyrius of Tyre.
Symposium, 177, 198. Plato.
Symposium i, 9 ; iii, 27. Xenophon.
Alcibiades i. Plato.
A Problem in Greek Ethics, p.58. J. A. Symonds, Priv. print.
 511. see trans. from Plato in *Encyclopædia of Sexual Knowledge*,
 pp.449-451.
 512. *Sexual Life in Ancient Greece*, p.244. Hans Licht.
Iolaus. Edward Carpenter.
del'amour. Henry Beyle (Stendhal).
 513. *De Republica* ii, 10, 1272. Aristotle.
Laws, viii, 836. Plato.
Deipnosophistæ xiii, 602. Athenæus.
Geographicus x, 483. Strabo.
De educatione puerorum ii. Plutarch.
Müller's History and Antiquities of the Doric Race, bk. iv, ch. 4.
 ¶ 6.
 514. *De Republica Lacedæmoniorum*, 2, 13. Xenophon.
 515. *Lycurgus* 18. Plutarch.
 516. *Symposium*, 178. Plato.
Anabasis vii ; iv, 7. Xenophon.
Var. Hist., iii, 9. Aelian.
Græciæ Descriptio ix, xxiii, 1. Pausanias.
Olympia, vii, 84. Pindar.
The Greek Poets, ch. iii. J. A. Symonds.
Deipnosophistæ, bk. xiii, 12, 78. Athenæus.
Eroticus, ¶ 17. Plutarch.
Historiæ, vi, 54, 56. Thucydides.
De amicitia vinculo, iv, 7. Valerius Maximus.
 517. Athenæus. *Alexander the Great*. Arthur Weigall.
 518. *Sexual Life in Ancient Greece*, p.418. Hans Licht.
 519. *Ethics*, viii. Aristotle.
 520. *Cambridge Ancient History*, vol. iv, pp.486-7.
 521. *Religious Experiences of the Roman People*, p.287. W. Warde
 Fowler.
 522. see 520, vol. viii, p.381.
 523. *Lives of the Cæsars*. Augustus lxviii, Suetonius.
 524. *Epigrams* xi, 71. Martial.
Lives "Sulla". Plutarch.
Cambridge Ancient History, vol. ix, p.729.
 525. *Lives of the Cæsars*. Augustus, 71. Seutonius.
 526. *ibid* : 69.
 527. *Sexual Life of Ancient Rome*, p.311. Otto Keiffer.
 528. *Lives of the Cæsars*, Tiberius xlvii. Seutonius.
Hist. i, 78 ; ii, 2. Tacitus.
 529. *Satires*, iv, 122. Juvenal.
 530. *Nero*. Arthur Weigall.
 531. see 525. Otho iii.
 532. *Decline and Fall*, vol. i, p.106. Gibbon.
 533. *ibid* : vol. i, p.101.
 534. *ibid* : vol. i, p.110.

REFERENCES

535. *ibid* : vol. i, p.122.
 536. *ibid* : vol. i, p.156.
 537. *ibid* : vol. i, p.186.
 538. *Satyricon*, 156. Petronius.
 539. *Decline and Fall*, vol. i, p.186.
 540. *ibid* : vol. i, p.415.
 541. *Bury's Roman Empire*, p.592.
 542. *Five Stages in Greek Religion*, p.197. Sir Gilbert Murray.
 543. *The Gospel and the Church*, p.125. Charles Raven.
 544. Essay by Dr. R. Briffault in *Sex and Civilization*, p.49.
 545. *An Historical Introduction to the Study of the Books of the New Testament*, p.327. G. Salmon.
The Mother's, vol. iii, p.327. Dr. R. Briffault.
 546. *ibid* : pp.333,340.
 547. *Liber de Exhortatione* in Migne. *Patrologia Cursus Completus*, series prima, vol. ii, col. 924 sq.
 548. *Epistola xxii*, 2, Jerome in Migne. *ibid*: vol. xxii, col. 397.
 549. *Exhortatio virginitatis*. Ambrose in Migne. *ibid*: vol. xvi, col. 346.
 550. *The Mothers*, vol. iii, p.248. *ibid*.
 551. *Historia Ecclesiastica*, vi, 8. Eusebius.
 552. *In Matthew xvi*. Origen.
Apologia I, pro Christiana xxix in Migne, *ibid* : *Series Graeca*, vol. vi, col. 737.
 553. *De cultus faeminarum* Tertullian in Migne *ibid* : *series prima*, vol. i, col. 1305.
 554. *Stromata*, vii, 12. Clement of Alexandria, in Migne. *ibid* : vol. Graeca, vol. ix, col.497,499.
 555. *Paedagogus* ii, 2. Clement of Alexandria in Migne, *ibid* : vol. viii, col. 429.
 556. see note 548, xxii, 2.
 557. *The Mothers*, vol. iii, p.426, note 1.
 558. *Cambridge Mediaeval History*, vol. ii, p.40.
 559. *The Past and the Present of our Heresy Laws*, p.8 W. A. Hunter.
 560. *Opera*, iiii, 1. Irenaeus.
 561. *De Veris Illust.*, iii. Comment on Matthew (xii), bk. ii. Jerome.
 562. *Prologue to the Gospel of St. John*. Dr. Rendal Harris.
 563. *Nat. Hist.*, xxx, 13. Pliny.
 564. *Selected Essays*, vol. i, p.110. Max Müller.
 565. *Celtic Literature*, p.116. Matthew Arnold.
 566. *Life, an Outline of Biology*, vol. ii, p.1252. Sir Patrick Geddes and Sir Arthur Thompson.
 567. *Did Our Lord Visit Britain ?* p.31, Rev. O. C. Dobson.
 568. *Jeremiah* 6, v.14.

INDEX

A

- Abbots Bromley, II
 Aberdeen, 83, 116
 Aborigines, 8, 33, 107
 Australian, 25, 33
 Abraham, 25
 Abyssinia, church of, 136
 emperor of, 64
 Achilles tomb, 42
 Achaius, 104
Acta Sanctorum, 65, 71
 Acvina, 81
 Acvins, the, 74
 Adriatic, 38
 Agincourt, 5
 Agricola, III, 117
 Agriculture, discovery of, 2, 31
 Aji-alon, 68
 Akenaton, 90
 Al, 12, 17, 29, 30, 62
 as power, 83
 = Cronos, 62
 of the oak, 68
 Ala Cross, 20
 Al — An, 30, 66
 Alan, 12, 13, 22, 29, 62, 67, 68, 69
 = Camel, 66, 72
 = gryffin, 70
 = light, 70
 = prophet, 70
 = the river, 72
 = wolfhound, 70, 79
 Albion, 24, 59
 Alexander the Great, 42, 129, 130
 as goddess, 90
 Alexandria, library, 135
 Alfred the Great, 55, 106
 as Arthur, 56
 Al-ford, 66
 Allen, Saint, 13, 65, 66
 Allendale, fire dance, 13, 70
 Allen's Wood, 18
 All Hallow'en, 14, 40
 Allon, 13, 29
 as oak, 67, 69
 Al-stone, 22, 65
 Alyen of Baal, 66
 Ambrose, Saint, 134
 Amen-Ra, 62
 Ammanianus, 107, 118
 Ammon, Saint, 65
 Amsu, 72, 83
 An, 17, 29, 30, 66
 Anau, 37
 Andra's Cross, 83, 95
 Andrew, Saint, 74, 83
 Aneurin, 60
 Anglesea, massacre at, 105, 120
 Ani, papyrus of, 89
 Ann, saint, 30
 Annis Hill, 66
 Ann's Head, 66
 Annu, see *On*
 Annubis, 70
 Anu, 29, 30, 66
 Arthur's sister, 56
 in Ireland, 30
 Saint, 65
 Antiochus, 85, 119
 Apollo, II
 in Britain, 59
 groves of, 28, 107
Architecture, History of, 117
 Argo, 36
 Aristotle, 129
 Arles, Council of, 105
 Armada, 100
 Armageddon, 31, 80
 Armistice Day, 14
 Armitage, H., 10, 107
 Armstrong, L., 6
 Arnold, Matthew, 3, 137
 Arthira-gus, 57
 Arthur, 53, 56, 57, 80
 bastard, 76
 buried, 87
 court of, 56
 Geoffrey's king, 54, 106
 God-King, 55
 Grove of, 18
 killed, 66, 72
 son of Uther, 56
 Arthur's Resurrection, 56
 Round Table, 45
 Seat, 28
 Twelve battles, 56
 Arviragus, 57
 Ascetic movement, 133, 134
 Athens, 27
 Academy, 135
 Assembly, 129
 Astrology, 53, 59
 Atlantis, 6, 7
 Augustine the Great, 73
 of Canterbury, 56
 Augustine's Oak, 105
 of Canterbury, 46
 Augustus Caesar, 28, 68, 109, 112,
 130, 131
 Aulus Hirstus, 131
 Aulus Plautius, 110
 Aurignacians, 5
 Avalon, 13, 28, 57

INDEX

- Avebury, 39, 42
 Circle, 14, 63
 Lord, 39, 118
 Azillians, 6, 7
 Azores, 6
- B
- Baal, II, 12, 19, 66, 90
 = Bael, 67, 72
 of Israel, 82
 prophets of, 72
 = Yahweh, 62
 Babylon, 34, 74, 86
 Bacchus = Michael, 80
 = Pluto, 80, 87, 95
 saint, 65
 Bal & vars, 12, 62
 Old, 21
 = Horned God, 51
 Tor, 68
 Bael, 12, 67
 Balan, 12, 13, 62, 65, 72
 of Dinsul, 69
Balane, 69
 Balearic Isles, 38
 Baltic, 7, 8
 Balton, 65
 Bakaire Indians, 47
 Bambi, 24
 Bangor, 105, 114
 library, 105, 135
 Banner, Indra's, 81, 85
 Barate = Britannia, 96
 Barber's Pole, 78
 Bardus, 24
 Baring-Gould, Rev. S., 65
 Basque language, 7
 Bastard, 15, 46, 47, 76
 Battle-axe Invasion, 63
 Beakerfolk Invasion, 39, 40
 Beal, 13, 69
 Be-alan, 13, 69, 72
 Bede, the Ven, 54
 Bel, 19, 62
 as Giant, 59
 as Horned God, 51
 as Indara, 83
 fire, 50
 Gate, 20
 groves of, 17, 21
 Mount, 17, 18, 22, 69
 Old, 21
 Stone, 68
 the Creator, 137
 Bellinus, Saint, 65, 69
 Belin Gate, 21, 88
 Belinda, Saint, 65
- Belpoor, 68
 Beltaine, 69
 Benedict, xiv, 77
 Bercius, the black traitor, 108
 Bermomondsey, 20
 Beth-el, 68
 Bible, the, 99, 103
 gaps in, 24
 reform of, 102
 Bibulus Curio, 123
 Billingsgate, 20
 Bosse, 88
 Birrel Augustine, 21
 Blackfriars, 16
 Blake, W., 120, 137, 139
 Bleasdale (woodhenge), 40
 Boadicea, 116, 117, 120
 speech of, 121
 treasure of, 114
 Boanerges, 81, 84
 Boaz, 90
 Bohemia, 38
 Bolsche, W., 47
Book of the Dead, 53
 Bosphorus, 77
 Botha, 16
 Bragg, Sir L., 2
 Brahma, Goose God, 84
 Brazil, 47
 Briaterus, a giant, 61
 Bride, 30, 38
 Heavenly, 49
 Bride's Fields, 66
 Port, 66
 Well, 30
 Bridge, London. Martial on, 119
 Bridget, Goddess, 19, 30, 38
 Order of, 19
 Saint, 65, 66
 Briffault, Dr. R., 25, 26, 75, 107,
 134
 Brigantium, 38
 Bridegroom Heavenly, 62
 Bristol. Bishop of, 54, 85
 Brit & variations, 87, 106
 Britain, Mother country, 31
 new *History of*, 112, 117
 Star Temples of, 14, 36
British History, Eclipse Of, 103
 Britannicus, 57
 Britomart, 87
 Britany, 7, 87
 Britannia, 30, 74, 87, 118
 daughter of Phoenix, 96
 as Great Mother, 97
 Broad Sanctuary, 63
 Brut, 87, 106
 the Trojan, 100, 104
 Bu-Anu, 29

INDEX

Budge, Sir A. E. W., 14
 Bull the White, 50, 104
 Bund, Sir W. le, 93
 Burkett, M. C., 39

C

Caer-Sidi, 59
 Caesar, Julius, 107, 108, 109, 110,
 112, 122, 125, 128, 130, 131
 Blake on, 120
 as "queen," 123
 cruelty of, 124
 lampoon on, 109
 treachery of, 123
 Caius Decius, 116, 120
 Caligula, 109, 132
 Callan, Mount, 13
 Calvus, Licinus, 123
 Camden's hist., 70
 Camel, 66, 72
 Camelot, 72
 Camulodunum, 116
 Candlemas, 13, 14, 30, 40, 45
 Cannibalism, ritual, 34, 125
 Canterbury, antiquarians of, 100
 bishop of, 105
 Canute, king, 80, 86
 Capadocia, 77, 96
 Capitol, thatched, 115
 Capri, 131, 132
 Capua, 127
 Caracalla, emperor, 132
 Caradoc, the, 106, 107, 110, 116,
 119
 speech of, 106, 107
 saint, 70
 Caractacus, 57
 Carinus, emperor, 133
 Carmel, Our Lady of, 77
 mount, 72
 Carpenter, Ed., 85
 Carthage, 64, 118
 sack of, 63, 109
 Caspian Sea, 32
 Castor & Pollux, 74, 75, 77, 97
 ship of, 97
 Cato, 27
 Cauldron of Wisdom, 58, 60
 Cavan, Co., 19
 Cave of three brothers, 10
 of the devil, II
 Celibacy, 46
 Cerne Giant, II, 59, 66, 81
Cernunnos, II
 shrine of, 80
 Chalons, Council of, 105
 Chancellor, 133

Charlماغne, 54
 bastard, 76
 Charles II, 86
 Charles Martel, 76
 Charing X, 88
 Chaucer, 85
 Childe, Prof. G., 48
 Christ, 83
 Christos, 85
 Christians, 1st cent., 134, 136
 Christmas, 17, 40, 52, 84
 Father, II, 84
 Chronicles, British, 84, 99, 102
 of Lanercost, 41
 Churchill, Rt. Hon. W. S., 23
 Churchward, Dr., 83
 Cicero, 123, 127
 Clach Dearg, 86
 Clare, Saint, 19
 Claudius, Emperor, 27, 108, 132,
 139
 half-witted, 110
 Cleander, 132
 Clement of Alexander, 108, 135
 Clotwig, 76
 Cock for God, 51
 thunder-bird, 89
 Colchester, 116
 Cologne, 56
 Commodus, Emperor, 132
 Common Law, 34
 Comus, 12
 Conaire, 76
 Conchiobar, 76
 Constance, Lake, 38
Constantine, Donation of, 54, 71
 Constantinople, 103
 library of, 135
 Cook, Dr. A. B., 82
 Corinth, founded, 37
 sacked, 109
 Cormac, Archbishop, 60
 Cornhill, 8, 85
 Coronation, 86
 Cosmos, Saint, 69, 77, 78
 Crassus, 123
 Crecy, 16
 Crete, 26, 32, 33, 36, 37, 38, 41, 42,
 63, 74, 87, 97, 104
 Diana in, 97
 Paul in, 97
 Cronos, 75, 79, 82, 84
 = El, 62
 = Indra, etc., 62
 in chains, 61
 Sanctuary of, 63

INDEX

Cross, the, 78
 Andra's, 94
 Broken, 92
 Dancing, 66
 Paul's, 94
 Red, 66, 74, 77, 78, 79, 90
 Stone Age, 48, 83
 Sun, 96
 death on, 127
 Crosses, London the, 17, 20
 Crucifix Lane, 127
 Crucifixion, the, 131
 Cuchilean, 76
 Cul Cross, 20
 Culdee Church, II, 105
 Cummont, Dr. F., 53
 Cuno Belin, 70
 Cup of H. Grail, 58
 Curse of God, 45, 61
 Cynddelw, 59
 Cymri, the, 103
 Cynics, the, 28

D

Dalan, the Druid, 69
 Damien, Saint, 77
 Danube, 37, 38
 David, 90
 Princesses of, 63
 Davies, E., 59
 Dawkins, Prof. B., 119
 Dealande, 70
 Dead, Feast of, 21, 52, 92
 Decretals, the False, 71
 Democracy, Mother of, 113
 Diana, 87, 90, 91, 97
 lamps of, 95
 of Ephesus, 97
 temple of, 93, 94
Dinsul, 69, 70, 72
 Dioclitian, Emperor, 105
 Diodorus Siculus, 58, 106, 107,
 108, 121
 Diogenes, 70
 Diogenes Laertius, 107
 Dion Cassius, 121
 Dion Chrysostom, 107
 Dionysus, converted, 97
 eaten, 125
 into Pluto, 87
 red, 78
 Saint, 65
 Dioscuri, the, 74, 79
 Dog, domesticated, 9
 as prophet, 81

Dog—
 sacred, 70, 89
 scribe, 70
 sodomite, 71
 Star, 70
 of Zeus, 70
 Dolabella, 123
 Dolon, the Trojan, 69
 Door of Heaven, 69
 Dorking, play at, 60
 Dowden, Dr., 51
 Dove, the, 36
 Dragon, Alan slays, 70
 rue du, 80
 of Chester, 61
 of Darkness, 60, 82, 83
 Michael slays, 72
 of Uffington, 59
 Uther, 56
 Durham, phoenix at, 90
 sanctuary, 64

E

Ea, 66
 Easter, 40, 49
 Eden, garden of, 29, 31
 grove, 17
 Park, 20
 the British, 29, 45, 52, 61
 Edict of Donation, 54
 Edinburgh, 28
 Edmund Ironside, 92
 Edward the Confessor, 80, 92, 106
 Edward IV, 86, 92
 Education, Roman, 107, 127
 Egypt, 26, 32, 34, 36, 37, 109
 Eiden, Rampart of, 28
 El, 17, 68
 = Cronos, etc., 17, 62
 = Sun, 68
 El Elohim, 62
 chief of dancers, 67
 El Elyon, 67
 Eleanor Crosses, 88
 Eldon Grove, 17
 Elon, the Hittite, 69
 Elijah, 72
 Elias, fire of, 19
 mount, 72
 Saint, 65
 Elizabeth I., 17, 88, 93, 100
 Elmo's Fire, 19
 Enchantments of Britain, 58
 English Channel, 77
 Epicureans, 28

INDEX

Erech, 36
 Esau, 82
 the Red, 69, 75, 76
 Esh-Baal, 85
 Essex sinks, 38
 Etruscans, 27
 Euripides, 125
 Evans, Sir A., 33
 Sir J., 39
 Eve, the British, 29
 Evolution, wrong turning, 31
 Exodus, 71
 Ezra, 69

F

Fal, Stone of, 86
 Fairies, The, 45
 Farrar, Dr., 7
 Father-God, 29, 62
 Fechuan, Abbot, 63
 Fenchurch, 17
 Fergusson, J., 117
 Fertility, God of, 72, 81
 Goddess of, 30
 Fion, 76
 Fire Dance, 10, 13, 70
 Goddess of, 30
 Firth of Forth, 117
 Fleet, the, 8, 16
 street, 16
 Flogging, Roman, 127
 Flood, The, 24
Forneau du diable, II.
 Fontenu, Abbe, 39, 118
 Foutin, Saint, 69
 Frazer, Sir James, 14, 62
 on Candlemas, 30
 on Chrestos, 85
 on Hannah, 68
 on St. George, 77
 on the vine, 81
 Friar's Heel, 68
 Ful-ford, 22, 65, 127
 -gate, 21
 -river, 8, 22
 -well, 20

G

Games, Roman, 124
 Gannymede, 129
 Gaskell, Mrs., 9
 Garter, The, 10, 80
 Gate of Hell (women), 135
 Gauthin, Saint, 46
 Geddes, Sir P., 137
 Genesis, Book of, 53
 Geta, 110

Geoffrey of Monmouth, 53, 54, 56,
 104, 105, 106
 George, 79, 96
 Mad Saint, 77, 80
 Acts of, 65
 Mintage, 79
 George V, 2
 VI, 35
 Geur, 76
 Giant, Briareus a, 61
 Bell as, 59
 canvas, 51, 95
 Cerne, II, 59, 66, 81
 the Willmington, 59
 Giants, land of, 59
 Gog and Magog, 59
 Gibbon, Edward, 128, 133
 Gildas, 54, 106
 Giza, pyramids of, 37
 Glastonbury, 13, 38, 65, 66, 88,
 105
 Joseph at, 64
 paradise, 61
 zodiac, 53, 57, 58
 Goat-God = Indra, 81, 82
 God-Emperor, 28, 105, 109, 123
 Gog and Magog, 59, 79
 Goose, The, 78
 Brahma, 84
 Michael's, 72, 73, 79
 of Priapus, 72
 Seb, 79
 slain, 72, 73
 turns to Swan, 79, 96
 Gordon, E. O., 91
 Gorgos, 76
 Gospel, original lost, 136
 St. Matthew's, 136
 Gospels, The, 84
 Grail, the Holy, 56, 135
 Cup of, 58
 Gregory the Great, 93
 Greece, 12, 26, 27, 34, 36, 38, 62,
 63, 74, 118
 Green's Farm, 21
 Griffith, Rev. J., 15, 60, 92, 104
 Grimes Graves, 26
 Groves, the London, 17
 Gryffin, the, 70
 Guildhall, 79, 94
 Guinivere, Queen, 57
 Gurlett, L., 111

H

Haddon and Stubbs, 101
 Hadrian, 111, 117
Hagia Tridia, 26, 89
 Haldane, J. B., 3

INDEX

- Hallow'en, 14, 40, 45
 Hallow-mass, 17
 Ham Common, 20
 Hamilton, Dr. M., 65, 72
 Hammurabi, 35
 Hannah, 68
 Hannibal, 119
 Hanno, 118
 Harris, Dr. R., 74, 75, 136
 Harwicke, Lord, 135
 Hate, spiral of, 31, 47
 Hawkes, Jacquetta, 44, 116, 120
 Heard, Gerald, 30
 Hecataeus, 58
 Heel, Friar's, 68, 69
 phallus, 68
 Hele Stone, 68
 Helen, 75
 Gardens, 20
 Helena, 19, 75
 Helios, 72
 sons of, 59
 Heliogabalus, 132
 Hell Fire, 134
 Henry V., 19
 VIII, 18, 19, 63, 92, 100
 of Huntingdon, 121
 Hercules, 24, 90
 Heres, Mount, 68
 Hermes = dog, 70
 = ithyphallic, 42
 Rod, 78
 Saint, 65
 Herne, the Hunter, 11, 12
 Hill, 66
 Hephaeston, 129, 130
 Hesus, 101
 Het-Ben-Ben, 89
 Hierocles, 132
 Higgins, Geoffrey, 121
 Hindu Kush, 74
 Hol, river, 8, 16, 21
 ford, 65
 Holderness, 38
 Holy Grail, Order of, 56, 135
 Cup of, 58
 Holy Oak, 20, 69, 88
 Well, 22, 49, 65
 Home, Gordon, 108
 Homer, 69, 75, 101
 Homosexuality, Greek, 129
 Roman, 130
 Horace, 109
 Horn of Unicorn, 82
 Horned Dancer, 11
 1620, 12
 as God, 19, 29, 49, 50, 51, 81
 into Pluto, 87, 95
 Hornie, Old, 11, 29, 34, 70
 Horus-Egyptians, 36
 Host Heavenly, 82
 Howel-Smith, A. D., 71, 111
 Hu, the Mighty, 60, 92, 103
 Hull, E., 93
 Human sacrifice, 33, 44, 121, 125
 Hungary, plains of, 36
 Hunter, Dr., 136
 Hyrcanus, John, 71
 Hyppolytus, 107, 108
- I
- Ia, 70
 Ice Age, 5, 6
 Icini, the, 116
 Iliad, the, 75
 Indara, 83, 84
 Indra, 62, 75, 81, 82, 83
 Banner, of, 81
 and Brahma, 84
 in chains, 84
 India, 62, 69, 76, 83
 Indo-Europeans, 74, 96
 Infanticide, Christian, 128
 Inge, Rev. W. R., 3, 54
 Insula-av-Allon, 13, 65, 87
 Intui, smashing of, 33
 Inverkeithy, 41
 Irenaeus, Bishop, 136
 Ireland, 64, 86, 104, 105
 First king of, 104
 Isaac, 76
 Island Sacred, 28
 Israel, ancient, 71, 72
 lost, 72
 mantel of, 72
 Old, 52
 prophets of, 51, 71, 82
 Unicorn of, 82
 Italy, 69, 74, 128
- J
- Jachim and Boaz, 90
 Jacob, 75, 76, 80, 82
 James I, 92
 Japhet, 24
 Jehovah, 62
 Jeremiah, 63
 Jericho, fall of, 63
 Jerome, Saint, 134, 135
 on lost gospel, 136
 Jerusalem, 63
 sack of, 109
 Jephtha's daughter, 14
 Jesus, 84

INDEX

Joan of Arc, 73
 John and James, 84
 Joseph of Arimethea, 64
 Josephus, 72
 Joshua's Oak, 67
 Jowett, Dr., 7
 Judah, 71
 Lion of, 82
 Jupiter, 62
 red, 78
 phallus of, 85
 Justinian, Emperor, 136

K

Karm festival, 81
 K.D.S.H., 71
 Keiffer, Otto, 127
 Kendrick, T. D., 53, 54, 100, 101,
 103
 Kingfisher Pond, 18
 King's Knot, 41
 King, C. W., 70
 Kish, 36
 Knossos, double axe of, 83
 fall of, 63, 104

L

Lake-dwellings, 38
 Lammas, 13, 14, 17, 19, 40
 Road, 20
 Lanercost, Chronicles of, 41
 Lars, the, 44
 Law, Roman, 126, 127
 Lea, Dr., 46
 Lea Stone, 86
 Leda and Swan, 79
 Lewis, Sir G., 118
 Lhyud, Humphrey, 87
 Liber, the, 80
 Life, Tree of, 29, 50
 Lily, George, 100
 Lindsay, Dr., 134
 Lingam, Christos, 85
 Lion of Judah, 82
 Livingstone, Sir R., 1
 Lockyer, Sir N., 14, 15, 44, 60,
 92, 104
 Loftie, W. J., 119
 Logres, Kingdom of, 58
 London, 15, 16, 77, 110, 116, 118
 age of, 14
 Bridge, 119
 Crosses, 17, 20, 88
 History of, 119
 Roads, 119, 120
 sack of, Danish, 94
 sack of, Roman, 118

London—
 site of, 8, 9, 27
 Stone, 91, 92
 Lourdes, prehistoric shrine, 10
 modern shrine, 49
 Love, British, 135, 138
 Greek, 128, 129
 Platonic, 128
 Roman, 130
 Lovelace Green, 18
 Louis xviii, 64
 Lucius, King, 63, 100, 101
 Ludgate Hill, 8, 30
 Lud's Hill, 88

M

Macdonald of the Isles, 86
 Mage, 10
 Magna Mater, 85
 Makh, 78
 Maiden Castle, 39, 48, 91
 Malta, 5
 Maltwood, A. E., 57, 58
 Man, Isle of, 14
 Manoa's wife, 68
 Marcus Aurelius, 27, 132
 Marcus Brutus, 123
 Mari Llwyd, 10
 Margaret, Saint, 95
 Mars, 11
 Marylebone fields, 9
 Mary Magdalene, Bridget, 66
 Marriage, customs, 9
 denounced, 134, 135
 economic union, 45
 grossly immoral, 46
 Plato on, 28
 Martial, on bridges, 119
 Martin, Saint, 92, 94
 Massingham, H. J., 60
 Matthew, 136
 May Day, 13, 14, 17, 18, 30, 34, 40,
 55, 60, 72, 77
 Labour Day, 13, 21
 Mayfair, 17, 18, 19
 May Pole, the, 18, 50, 81, 85
 May, Queen of, 49, 51
 Megalithic culture, 42
 Memory, daughters of, 139
 Meru, Mount, 81
 Mesopotamia, 37, 61, 72
 Messalina, 132
 Michael, 31, 61, 65, 94, 95
 apparation of, 77
 = Bacchus, 80
 = Divine Twin, 66, 76
 = Door of Heaven, 69
 = God of Fertility, 72, 79

INDEX

- Michael
 goose of, 72, 73, 79
 mintage, 79
 Midsummer at, 65
 Mount, 13, 65, 68, 70, 73, 77
 naked, 31, 71, 73, 79
 Sun God, 60
- Michel, Boulevard de St., 80
- Midsummer Day, 17, 40, 60, 76,
 87
 Watch, 17, 50, 94, 95
- Mi-Ki-Gal, 72, 76
- Mile End, 17, 18
- Miletus, Bishop, 93, 94
- Milton, 12, 139
- Minos, 97
- Minotaur, 104
- Mithra, 85, 86
- Montparnasse, 80
- Moorgate, 16
- Morals, European, 46, 133, 135
 Greek, 128, 129
 Roman, 130
- Morgan, Prof. Lloyd, 14
- Mosaics, Roman, 115
- Moses, 71
- Mosso, Dr., 26
- Mother, the Great, 19, 24, 27, 29,
 49, 62, 88, 89, 90, 91
 altar, 50
 = Bridget, 19, 30, 38
 = Britannia, 30, 31, 97
 earth, 26, 30
 fire of, 49
 phallus of, 26, 49, 51, 88
 titles of, 30, 87
- Mount Sacred, 28, 49, 71, 76
 of Beth-el, 68
 of Stone, 19
 the Golden, 81
 Syon, 19
- Muluy, 86
- Murray, Sir Gilbert
 on asceticism, 133, 134
 on books destroyed, 55
 on Spring Dance, 11
- Murray, Dr. Margaret, 122
- Music, Old English, 55
- Mussolini, 102, 125, 138
- Mycean Greece, 27, 63
- Natasy Twins, 75
- Nemi, 94
- Nennius, 54, 56, 104, 114
- Neolithic Age, 32, 38, 44, 47
- Nero, 94, 116, 118, 120, 132
- Neptune, captive, 110
- Newcastle, 86
- New Testament, 31, 84
- Nick, Old, 11, 12
 of Barnet, 22
 Canonised, 65
- Nicholas, fire of, 19
 Saint, 11, 65
- Nietzsche, 3
- Nile, the, 7, 32, 70
- Ninth Legion, 120
- Noah, 24
- Noah's Ark, 36
- Norfolk sinks, 38
- Northumberland, Dukes of, 19
- Notting Hill Gate, 20, 21
- Nuts, sacred, 50
- O
- Olan's Stone, 68
- Oak = Allon, 67
 Augustine's, 105
 Hill, 18
 Holy, 20, 69, 88
 Joshua's, 67
 and lightning, 82
 of the pillar, 67
- Oath, 89
- Old Testament, 31, 68, 82, 89
 euphemisms in, 69
 gaps in, 24
- On, 32
 temple of, 89, 90
- Origen, castrated, 135
- Orkneys, 44, 45
- Orpheus and Eurydice*, 128
- Osiris, death of, 14
- Otho, Emperor, 132
- Otto, Emperor, 56
- P
- Pal, Old, 22
- Palmer, R. L., 95
- Paradise, 28
 Hill, 13, 29, 49, 61, 65
 Lost, 29, 61
 Old, 20, 21, 61, 127
 Prince of, 60
 regained, 29, 31
 street, 20
- N
- Naked Horsemen, 73, 74, 94
- Napoleon, 3, 16, 138
- Narcissus, Eunuch, 110
- Narmer-Menes, 33

INDEX

- Paranoia, 126, 133
 Paris, Council of, 46
 Parthenoi, 27
 Parthenos, 96, 97
 Parliament Hill, 15, 92
 Paul = Mercury (Hermes) 97
 Paul's Cathedral, 15, 79, 88, 91,
 92, 94
 deer in, 88, 93
 Cross, 92, 94
 Stump, 88, 91
 voyages, 97
 Paulus, Old, 22, 94
 Pawlie Old, 30
 Peake and Fleure, 33, 39, 104
 Pepin, 54
 Persea Tree, 89
 Persia, 74, 85
 Peter = Mithra, 86
 the rock, 84, 85
 Peter's pence, 100
 Phallus, Allah's, 89
 Belin's, 88, 94
 Jupiter's, 85
 garlanded, 50
 Mother's, 26, 49, 51, 88
 into tombstone, 80
 red and white, 78
 on Roman chariots, 88
 violets on, 49
 = Chrestos, 85
 = Friar's Heel, 68
 = Hermes' Rod, 78
 = Liber, 80
 = lingam, 85
 = thigh, etc., 69, 89
 = vine, 81
 Phillip of Macedon, 129
 Phoenicia, 63, 96
 Phoenix, 89
 daughter of, 96
 at Durham, 90
Pimpernell, Scarlet The, 53, 102
 Pinhole Cave, 11
 Plato, 128, 129
 on Atlantis, 6, 7
 on marriage, 28
 virgin-born, 27
 Plato's Academy, 135
 Platonic love, 128
 Pliny, 107, 118, 136
 Plutarch, on Alexander, 129
 on Cronos, 61
 Pluto, 80, 87
 the London, 95
 Pol, Old, 30, 91
 Pole, Cardinal, 100
 Polybius, 27
 Polycarp, 136
 Polydore Virgil, 100, 106
 Pomponius Mela, 121
 Pompey, 123
 Pool, Dr., 118
 Portugal, 39
 Priapus, canonised, 69
 geese of, 78
 nuts of, 50
 rites of, 41
 = Sun (*Helios*), 68
 Primrose Hill, 92
Prometheus Bound, 127
 Prydain, 87
 Ptolomy, 117
 Pyramids, the, 33, 37
 Pythagoras, 108, 121
 Pythias, 118
- Q
- Queen's Camel, 66, 72
 Quest, the, 58
 Quintus Hortentius, 27
- R
- Ra, 62
 blood-bath to, 33
 Rabelais, 69
 Raglan, Lord, 102
 Ramayama Epic, 75
 Raven, Canon C., 134
 Red, 78
 Cross, 66, 74, 77, 78, 79, 90
 robes, 84
 Sea, 82
 Stone, 86
 Twin, 76
 Red Indians, 78, 101
 rutting season, 13
 Rhine frozen, 116
 pile dwellings, 38, 39
 Rhys, Sir John, 14
 Rig Veda, 74, 81
 Riley Smith G., 68
 Road, the British, 119
 Robertsons, the, 86
 Roland, 76
 Rolin, 118
 Rome, 26, 27, 28, 34, 88, 110, 115
 Romulus and Remus, 30, 79
 Round Table, 45, 135
 Order of, 56
- S
- Sacred Hill, 19
 Mount, 28, 49, 65, 72, 76
 Stone, 22

INDEX

- Sacred
 Tree, 22, 29, 30, 48, 82, 89, 91
 Wedding, 29, 51
 Saints, Lives of, 65
 Salisbury, 115
 Down, 40, 41
 Samuel, birth of, 68
 buried, 44
 and Saul, 23
 Sanctuary, 63
 St. Martin's, 92, 94
 Westminster, 63, 92
 Sand, for weddings, 9
 Santanda, 5
 Sardinia, 38
 Sargon, 35, 37
 Sarah, 68
 Satan, tool of (women), 135
 Saturn, 62
 = El, Cronos, etc., 62, 84
 Saint, 65
 Satyrus, Saint, 65
 Saturnalia (Xmas), 28, 84
 Saul, naked, 51
 Savasrate, 84
 Saxony, 38
 Schliemann, H., 101
 Scriptures, Messianic, 24, 69
 Scone, Stone of, 86
 Seb, the Cackler (goose), 79
 Seneca, 116, 120
 Septimus Severus, 132
 Set = Cronos, etc., 62
 Shakespeare, 12, 17, 18, 51, 127, 139
 Shaw, G. B., 102, 124
 Shetland, 118
 Shooter's Hill, 18
 Sicily, 5, 59
 Sidin, circle of, 59
 Silures, Clan of, 110
 Simpson, Canon, 93
 Sirius, Dog Star, 70
 Skara Brae, 44
 Smithfield Market, 46
 Snefru, 37
 Slave chain, 120, 121
 Socrates, 28, 128
 seduced, 129
 Solomon's Temple, 90
 Solutreans, the, 5, 7
 Sons of God, 29, 76
 of Thunder, 84
 Spain, 6, 39
 Sparta, 27, 68
 Spence, Lewis, 40, 58, 122
 on Atlantis, 7
 Spring Dance, 11
 Festival, 12, 28, 48
 Sporus, 132
 Stafford, horn dance, 10
 Stanley's Africa, 107
 Star Temples, 14, 36, 40, 53
 Stephen, the martyr, 64
 Stinnes, 45
 Stirling, 41
 Stone Age, 36, 42, 47, 48, 49, 95,
 festivals, 17
 New, 32, 44, 45
 Old, 5, 8, 10, 15, 18, 22
 Stone of Fal, 86
 of London, 88, 91, 92
 of Scone, 86
 of the standard, 86, 90
 Stonehenge, 40, 41, 42, 58, 59, 68,
 91, 115
 Storm God, 81, 82, 84, 94
 Strabo, 118
 Stuarts, the, 43
 Stow, John, 95
 Strubbe, Judge Stanley, 126
 Suetonius, 123, 130, 131
 Suetonius Paulinus, 110, 117, 120
 Sulla, 130, 132
 Sumeria, 26, 34, 74, 97
 Surya, 75
 Swan into goose, 79, 96
 knight, 56, 79
 Swithin, Saint, 91, 92
 Syon, 19

T

 Table of Holy Grail, 58
 Tacitus, 106, 116, 118, 131
 Taliesen, 59
 Tara, Hill of, 68, 86
 Taran, 137
 Tardenosians, 6
 Tarpeian Rock, 127
 Taylor, Gordon, 31
 Hugh, 3, 99
 Tem, 78
 Tents, meadow of the, 66
 Terra del Fuego, 33
 Tertullian, 134
 Thames, 8
 Thigh = phallus, 69, 89
Theos, 85
 Theseus, 104
 Thompson, Sir A., 137
 Thunder Bird, 90
 Bolt (Jove's), 85
 Sons of, 81, 84
 Stone, 82, 84, 85, 86
 Tiberius, Emperor, 131
 Timagenes, 108
Times, The, 46
 Titus, Emperor, 111

INDEX

- Tohill, 15
 Trajan, Emperor, 128
 Transfiguration, The, 84
 Treachery of the Long Knives, 41
 Tree of Life, 29, 50, 70, 84, 90, 95
 love-provoking, 69
 and pillar cult, 23, 89
 Sacred, 49, 82, 89, 90
 Trent, Council of, 135
 Triads, the, 137
 Trojan descent, 100
 Troy, 39, 75, 101
 I, 37
 II, 38, 103
 VI, 27, 74
 fall of, 63, 104
 Indara at, 84
 New, 77, 106
 Paul at, 97
 Tudor, House of, 100
 Twelfth Night, 14
 Twin Cult, 84
 Twins, the Heavenly, 74, 75, 76, 77,
 78, 81, 90, 94, 97
 Tyre, 90
 Tyburn, 8
- U
- Unas, cannibal king, 34
 Uffingham dragon, 59
 Unicorn, 10, 81
 chained, 82
 of Israel, 82
 v. lion, 81
 Ur, 36
 Uther, Arthur's father, 56
- V
- Valerius Maximus, 107, 108
 Vedic hymns, 74, 81
 Venere, saint, 65
 Venice, 38
 Vespasian, Emperor, 72, 111
 Vestal virgins, 85
 Victoria, Queen, 45
 tower, 9
 Vine = phallus, 81
 Vineyards, dance of, 68
 Virgil, on Rome, 108
 on Troy, 38
 Virgile Polydore, 100, 101
 Virgin-born, 27
 queen, 49
 Mother-An, 29
 Violets sacred, 49, 51
- Virility, colour of, 49
 Vitellus, Emperor, 132
 von Humbert, 118
- W
- Waddell, Helen, 106
 T.A., 3, 83, 102
 Ward, J. S. M., 83
 Wedding, Sacred, 29, 51
 Sand for, 9, 10
 Weigall, A., 132
 Well, Holy, 49
 Wells, H. G., 3, 99, 112
 Westminster, 8, 63, 86, 92
 abbot of, 101
 White Lady, 56
 Mount, 15
 Wilde, Lady, 14
 Wilde, Oscar, 123
 Wilmington, giant, 59
 Will-to-power, 127
 William the Bastard, 76
 the Conqueror, 92, 105
 the Devil, 76
 Wincobank Hill, 6, 39
 Windmill Hill, 39
 Windsor Forest, 11, 12
 Merry Wives of, 12
 Witness, pillar of, 89
 Woodhenge, 40
 Wolf of Death, 82
 of Rome, 30, 79
 Wolfhound = Alan, 70, 79
 Wren, Sir Christopher, 93, 94
 Wright, Edmund, 12
- Y
- Yahweh = Baal, 62
 Yesu, 137
 Yogi and virgins, 76
 Yorkshire, 5, 6, 11, 38, 110
 Youth, greatest of, 11
- Z
- Zachariah, 52
 Zeus replaces Cronos, 61, 62, 75, 79
 dancer as, 11
 dog of, 70
 and Ganymede, 129
 Zion, Protocols of, 117
 Zodiac, Glastonbury, 57, 58, 59, 66
 Druidic, 59
 Zoso, 37

