

Morphosephram:

The Handbook
Of
Shadow

by

William R. Wraith

אֲנִי מְנַסֵּה אֶת הַיָּדֵיכֶם לְבַדּוּם וְלֹא אֶעֱשֶׂה לָכֵן שְׂמָחָה וְלֹא אֶעֱשֶׂה לָכֵן כְּסוּף.

YOU ARE HEREBY BOUND BY SILENCE,
 ANY WORDS THAT ARE SPOKEN ALOUD
 OR ANY MATERIAL SHOWN TO OTHERS
 BESIDES YOURSELF REGARDING THESE PAGES
 WILL CAUSE GREAT KARMIC UPSET
 AND REPERCUSSIONS.

THIS IS A WARNING OF MERIT,
 GIVEN BY PHIMON, AMON, ORIENS, ASMODAI,
 AND MOBLOCH.

UPHOLD THIS AND YOU SHALL FIND
 ASCENSION. MOST IMPORTANTLY,
 YOU WILL ILLUMINATION OF YOUR SOUL.
 THEIR WILLS MAKE IT SO,
 SO SHALL IT THEN BE.

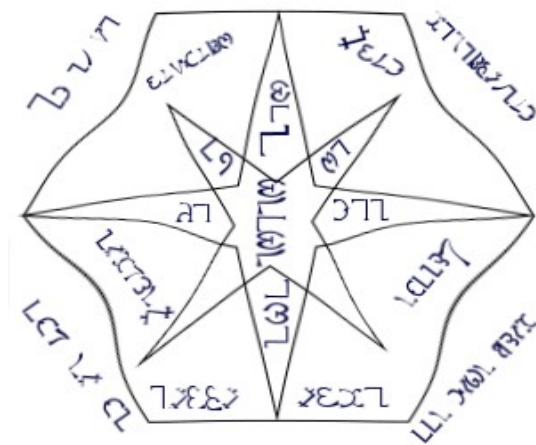

אֲנִי מְנַסֵּה אֶת הַיָּדֵיכֶם לְבַדּוּם וְלֹא אֶעֱשֶׂה לָכֵן שְׂמָחָה וְלֹא אֶעֱשֶׂה לָכֵן כְּסוּף.

Legal Disclaimer

Note: Even though this will be the first written text on explaining how to shape-shift properly, it is not to be taken lightly. No matter what you might think on or believe that shape-shifting is, I can guarantee that you are dead wrong.

First and foremost, the knowledge in this book is - and forever will be - very dangerous to those individuals who do not have the proper experience in the ethics and principles behind the art of summoning. When contacting and merging with highly advanced spirits and entities, the said individual - without proper experience and knowledge - can be presented with a perilous situation that cannot be undone once started. The material within these pages is not a beginners level book and should not even be considered as such. If you do make the mistake of thinking so - you will be forever damned like I am.

Furthermore, before performing any of the ritual magick in this book it would be wise to note all posted warnings and possible aftermath that could result in performing any or all of the said rituals. If you are in doubt or have questions about summoning, consult someone who knows what they are doing and knows about the risks involved.

My honest suggestion for the inexperienced beginner is to practice other works involving summoning and to get the experience you need before proceeding. I am asking you, please take care of my warnings, the consequences of not taking caution could hurt you or others around you. For those of you who warned me about the ethics and morales involved with the production of this book - safety has always been in the hands of the beholder.

It is also duly noted that this very book in your hands (for a very long time to come) will in fact be the very first text to explicitly instruct any individual on how to perform a full physical shift. This material is not made in jest, and will in no way reflect upon me in whatever decision you may make pertaining to the material inside. After this page you have boldly made the choice to take on whatever responsibility you will have to a new level of meaning. You will have stepped into the darker regions of magick forever.

Contents

Preface

Part 1: The Basics

Chapter 1: Understanding

- Were-creatures
- Shape-changers
- Vampiers
- Morphogenetic Fields
- The Base Sigil and Containers
- The Element of Shadow/Dark Matter

Chapter 2: Beginning Methods

Method One: Opening the Third Eye

- 1st Level Meditation
- 2nd Level Meditation
- 3rd Level Meditation

Method Two: Creation Of Sub-fields

- 1st Step : Alteration
- 2nd Step : Correlation

Method Three: Astral Awareness

- Separation
- Summoning Astral Winds
- Creating Shields

Chapter 3: Preparing the Sigils/Containers

- Physical Sigil/Container
- Astral Sigil/Container
- Spiritual Sigil/Container

Chapter 4: Energy Building Techniques

- Physical Energy
- Astral Energy
- Spiritual Energy

Part 2: Advanced

Chapter 5: Applying the Energy

Using the Sigils/Containers
Storing the Sigil/Containers

Chapter 6: Were-Creature Rituals

1st Ritual : Trial of Spirit & Air
2nd Ritual : Trial of Shadow & Water
3rd Ritual : Trial of Fire & Earth

Chapter 7: Vampier Rituals

1st Ritual : Summoning Mobloch
2nd Ritual : Merging w/ Servitor of Mobloch

Chapter 8: The Shape-changer Rituals

1st Ritual: Indome Iadosma
2nd Ritual: Iamra Iolial
3rd Ritual: Liel Ileiel

Chapter 9: Sigils, Symbols, Oils And Incenses Guide

Sigils
Symbols
Oils
Incenses



PREFACE



It has literally been quite the journey in preparing the book that now rests in your - I am assuming - very eager and curious hands. I will not lie and say that it has all been a very positive influence in my life - it is just the opposite - because a positive outlook would at least be something cherished and valued. I am reluctant with everything that has to do with this infernal book for two reasons, one - it ruined pretty much everything in my life and two - I lost something more precious than life itself - my humanity.

I had damned my soul to find out the truth and even though you will not have to sell your soul to become whatever you wish, my gift to you was my sacrifice to gain the knowledge in this book. I still want this to be a joyous occasion, one that would go down in history as something intelligent and remembered. To bring to light a text that would break the shell of misconception about the shadowed veil that is constantly being put up by so many lies and fabrications surrounding three things of mystery - were-creatures, shape-changers, and vampiers.

Not only have I heard everything concerning these three things, but I have witnessed many facades in my day to make one insane with anger, malice, and even outright resentment towards others that like to keep these illusions going. I was once a person who waded knee-deep in the bullshit of society trying to find the truth - a truth that seemed invisible for the most part. There are so many self-made charades in the present that even confusion has lost it's own definitive meaning.

No sane person would sort through the garbage just to find the truth all by themselves - no. I had help from other sources - quick and easy - or so it would have seemed. I cheated - by summoning and making a deal with certain demons, who gave me the necessary knowledge, so I could share it with you all - Paimon, Oriens, Asmodai, Amon, and Mobloch. Whoever that person was (her ignorant name will remain anonymous) that said summoning demons is an abysmal waste of time and energy - two words for you - bite me.

I lay now in a void of my own making - never to return to the normal world of understanding. It is now that I speak of my own damnation and what the price of truth looks like face to face.

For everyone who wishes to become one of the three things I have listed in this book - beware - the price might be too high. That price is called evolution of a species, one that will never be accepted by society.

I am trying not to walk on eggshells by upsetting people and going against what they say is truth - you people know who you are. I am also not trying to debunk all the gibberish that seems to accumulate on numerous web pages as well, but the fact of the matter is, it cannot be helped.

We all have different levels of what it is like to be different, even though you might seem to think there can never be any similarity - this goes beyond normal experiences. It seems to me that saying you are something is more relevant than actually being what you say - point in case - would you ever go the distance to be one of the things listed in this book, no matter what the cost, even if it means alienating yourself from family and friends?

This is the point I am trying to bring across - a dark future for all of those who wish to succeed in becoming what they desire. It is certainly not fun and games - it is not some RPG or group that you can quickly exit because of distaste. No, this is permanent, in exception with being a Vampier - you can banish the Mobloch entity from the host if need be, which in fact will return the person to normal, but the other two (were-creature and shape-changer), they are a permanent position.

The intent is a costly mark upon your soul, even if you were to banish the Mobloch entity and become human once again - it still reflects against you because the choice was already made - that decision triggered the first step in changing your karmic resonance.

This kind of karmic influence weighs badly for you on a universal scale and cannot be tipped back to balance what was lost. I suggest that if you have fallen away from any spiritual peace then this manuscript is honestly for you - otherwise, I would not act upon anything in this book.

In creation of this book, I have went against my better judgment, turned a deaf ear to those who hounded me on the morales and ethics involved, and truly strengthened all known precautions that would keep people safe from experiencing the same fate - all of this, so the world would have the choice I totally and utterly ignored by my own free will.

I believe this is to be the greatest test ever promoted to humanity - to hold themselves back from change, or to simply go with the flow of evolution. It is laid out before you now - in the pages of this book - either take the high road or stay on the low road. The high road will promote The Divine Change - the low road is being left to a normal life - your choice of course. So, as my words of wisdom go, if you must choose, then choose wisely. Believe me, karma has a very big mouth - and that mouth is the home to some major horrendous teeth. Please know right from wrong after the transformations occur.



PART 1: THE BASICS



Chapter 1: Understanding

1 - Were-creatures

What we once thought to be truth regarding were-creatures will no longer exist - all information on the subject will be cast far into the void of the forgotten. There is no set phenotype, no set claims, and no evident truth than what lies in these pages. All will be uncharted territory for you to stake your own claim. Also, it is not possible to bite someone and change them into one.

Were-creatures, on the whole, can be anything decided by the individual's wish and desire. There is only one set rule on being a Were - you can only change into one animal phenotype - that is the Universal Law dictated by POAA regarding the Morphogenetic Field needed to accomplish the transformation. There is no need to go into detail about the law but, if you are the cause for this upset, prepare for your own doom in every aspect you could possibly imagine - Karmic, Astral, Spiritual, Physical, and every other body there is.

Many Weres that are existing today (est. 400+)did not become what they are by magical creation. In fact, they are an existing race with the gene in their biological/genetic make-up and have been here just as long, if not longer, than even humans. They are careful as not to promote who and what they are - for valid reasons.

I will not give up either their names nor the exact locations for privacy, but I will give you an estimated ratio to the influences on a geographical scale that registers between Low and High - *High being most prominent and Low being least prominent (as dictated by POAA)*.

The locations that they have the most influence in the world is as follows:

Africa	(Moderate)
Antarctica	(Low)
Arctic	(Low)
Asia	(High)
Caribbean	(Low)
Europe	(High)
North America	(Low)
Oceania	(Moderate)
South America	(Moderate)

Another rule of thumb is that an individual can only transform into an animal of no less than the equal mass to their original human form (your body weight) or a slightly larger form of the animal phenotype intended. The mechanics behind this is: when the actual programming for the designated Morphogenetic Field to be a were-creature is set, it can only draw from the original mass of the human/phenotype form they correlate with.

The Element of Shadow triggers the field - in correlation with the Morphogenetic Field and Dark Matter, triggers the absorption of Dark Matter - the Dark Matter then creates the necessary accumulation of mass between the two bodies - in which part, the total transmogrification succeeds in whole from human form to phenotype form or vice versa.

Mechanics Breakdown:

**Awaken Third Eye --->Merge Astral/Physical Bodies --->
Creates Element of Shadow ---> Produces Astral Substance -
Dark Matter ---> programmed genetic/energy
signature/Morphogenetic Field is triggered ---> draws upon
the necessary Dark Matter Mass ---> creates necessary
balance in mass between the two correlating bodies --->
mental key thought creates genetic reaction --> triggers
transformation from human to phenotype/vice versa.**

When the said individual is ready to turn back into human form, the key thought will relay back to the Morphogenetic Field and thus, transformation will occur. The key to transforming back and forth between human and phenotype will be the programmed thought process, each significant key thought is a mental trigger.

Without this mental trigger they will not change. Remember this, it is the only way to return to normal - that is why it is a necessity to make sure you perform all meditations and methods extensively. I would not want anyone to be stuck in their phenotype form forever (one example is what happened in Elkhorn, WI - do not let this happen to you!).

There is also the fact of the three phases that a were-creature can shift into within the first three years of the ritual (may take a shorter/longer time period depending on the individual). For some it is very difficult to control, but with much practice it can be achieved to trigger these transformations by thought.

The three phases of transformation are as follows:

Human/Hybrid - (most noticeable in stage 1,2)

1. Slightly larger than normal body mass and height with apparent fuzz and hair.
2. Noticeable eye color change.

Hybrid - (most noticeable in stage 2 - not controlled)

1. Larger than normal body mass (usually 2x).
2. Animal-like body and head, somewhat in a resemblance of humanoid appendages.
3. Eyes are animal-like but represent the natural color of the individual's, brighter.

True Phenotype - (stage 3 : controlled)

1. True animal form of the phenotype represented. Slightly larger than normal animal (x2+).
2. Fur will represent color of natural hair of human form (it is generally decided by the Dark Matter's influence).

Last but not least, I will briefly explain to you of what can and cannot hurt were-creatures. It seems that after your merging of the physical body with the Astral Body, it creates what is known as an Intra-body. The Intra-body creates a flux in our reality which mostly surrounds it, and eventually permeates it until nothing can damage it permanently (Don't think that you cannot die though).

The flux, or bubble as I call it, holds the Intra-body in a stasis that is outside of the normal space/time reality even though the body can be touched, etc. I have come to the realization that this is the only way that the components of the transformation fit together in the puzzle (i.e., the mechanics above). It is what is called being a part of the tenth and twelfth dimensions, literally. You shall notice it when the cloud appears and the presence of the dark matter accumulates around you.

The end result would be rapid healing, regeneration of limbs, supernatural strength and speed, denser mass than that of normal (skin, hair, teeth, claws, etc.), abnormal longevity of life, acute seven senses (hearing and other extra-sensory abilities), some forms of psychic abilities, and other extraordinary abilities that a person could not grasp if not experienced first hand.

Other Side-effects are negative outputs such as anger, rage, depression - these have been factors in triggering an abnormal build up of the Dark Matter and can give unexpected results. Another Example would be abnormal side-effects such as discoloration of skin/eye/hair pigments, unnatural growth/size, and may also create animal behavior unlike natural law.

2 - Shape-changers

Unfortunately, shape-changers are not very widespread or as popular as were-creatures and vampiers. Their statistical numbers are very low and not many are left in the world. As far as I know, shape-changers are concentrated most in Asia and North America. As dictated by Asmodai, there are only a few hundred left in existence (or less).

Just as were-creatures use Morphogenetic Fields and draw from the Dark Matter of Shadow, it applies to the mechanics behind the shape-changer as well. Instead of one main Field and one substandard Field like the were-creature (i.e, human form and phenotype form), the shape-changer has many sub-standard Morphogenetic Fields interlinking with the main.

Each sub-standard Field, after the first, is then linked like a chain of sorts to the main Field. Each sub-standard carries a separate or different genetic/energy signature code of the desired animal or person desired. Each is also triggered the same way as the first, by the mental thought key necessary for the exact transmogrification desired, but as you can see this is more work and more memory.

Yes, that is correct, the shape-changer can not only morph into animals, but people as well. To be a shape-changer takes more work and more dedication though. The process to program multiple sub-Fields takes a long time and most beginners are sometimes confused with that of the were-

creature because the transformations do not always go as planned on the first trial periods.

Another fact, shape-changers do not have the same Dark Matter mass and therefore can morph into any sized animal or person desired. Since the Intra-body of the shape-changer has a different universal resonance than that of the were-creature, it is therefore possible for the Intra-body's mass to be withdrawn enough to assume the shape of something smaller (all details are explained in the Morphogenetic Fields section).

The Morphogenetic Field that will be programmed in correlation with the individual has to be set on accepting more than one sub-standard field. If it is not calibrated correctly the intra-body could lose it's grip on the Dark Matter - the least case scenario being no change and worse case scenario causing madness or other psychological illnesses and defects.

It is a constant process and you have to link all the sub-standards together to form the chain I had mentioned earlier. This process is called 'form tagging'. When you tag a form to another it acts as a conduit between forms. It channels the necessary genetic memory of the person/animal in the specific Field through the chain instead of being attached to you.

The Fields being linked in the chain makes it safer for the individual because otherwise all the Fields would ultimately overwhelm the host (too much information attached at one time and a possible overdose of residual Dark Matter). Too much Dark Matter mass at one time can have serious side-effects and possibly death.

I would estimate that the normal person with enough tolerance can in fact have up to three forms if they are persistent enough with the exercises and meditations. Otherwise, I would say one form for the person who tries to cut corners (if that).

There is another fact I would like to bring across about shape-changers. Sometimes it is possible to have tremors or seizures if too many forms are brought into the chain. One way you can prevent this is through meditation. You must raise the necessary energy very frequently, perhaps once or twice a month, and you must also perform the exercises regarding the Third Eye once a week.

3 - Vampiers

Let me begin this section by saying a few things involving Vampires - they do not exist. No, vampires are a myth made up by continuing hype in media and whatever other forms of vast imagination can drudge up inside it's little fantastic void. On the other hand, there are such things as vampiers, and with a little persistence, I will be able to bring back the true knowledge that deserves respect.

I know that everyone thinks the idea of some British looking vampire is sexy or what not, but why would you want some fanged aristocrat feeling you up with notions of nonsense about embracing you? This will indeed be kind of hard to fathom, but vampiers cannot turn people into like beings. I have no idea why this is, it just is. Sorry to burst the bubble, but the truth must be told.

Every vampier has an entity merged with him/her and that is how they obtain their abilities. Yes, the person was human, but after the merge they change into something else. It has been brought to my attention that people do not think it is a very wise action to merge with an entity. Of course, in the rule of thumb, this is correct - but concerning the entities that Mobloch sends, there is no major danger. The entity is a gift from Lord Mobloch, if He wanted to hurt or kill you, it would have been done in the ritual.

Here is a little secret about vampiers and how long they have been on this earth. It all started with a certain figure in history named Sargon. He made a pact with one of his dark gods who went by the name of Mobloch. In order for Sargon to reach his status as King he would need the power to succeed.

One night, he made his pact with Mobloch, who in return, gave him the power and influence to succeed in becoming King. Sargon literally conquered all and made his Akkadian Empire in a very short time. The only setback for his power is that certain Priests found out about his pact and started a revolt. They banished the entity from him and the punishment was his death.

That is the only way for someone to become human again, after they have merged with the entity, and that is to banish it with the proper ritual. Of course, the deal will still have been made whether or not if you decide to go

back on your word - the price must be paid and cannot be altered.

For those who wish to know the most popular locations concerning the Vampier, I have included a location list as I did for the Were-creatures. You will note that some of the world locations are not listed. The reason for this is that Vampiers do not like the cold, it reminds the entities about where they came from and causes some mild irritation.

They can, however, tolerate the cold such as winters and the like, but that is as far as they will go. I imagine that being from the void, or whatever Astral plane they come from, has made an impact that they do not like to imitate whatever the cause.

The locations that they have the most influence in the world is as follows:

Africa	(Low)
Asia	(Moderate)
Caribbean	(Moderate)
Europe	(High)
North America	(Moderate)
Oceania	(Moderate)
South America	(High)

Vampier facts:

- 1 - can go out in sunlight
- 2 - cannot be killed by projectiles
- 3 - holy items do not affect vampiers
- 4 - does not need to drink blood to survive
- 5 - does need energy to live
(host cannot provide enough for support)
- 6 - can use Dark Matter to change form
- 7 - following forms available to vampier:
 - a) bat form (same body mass or larger - Dark Matter)
 - b) wolf form (like were-creature - Dark Matter)
 - c) shade (uses Dark Matter from Shadow)
 - d) mist (uses Dark Matter from Shadow)
 - e) bat/wolf hybrid form
(uses Dark Matter from Shadow)

4 - Morphogenetic Fields

The theory concerning Morphogenetic Fields was that they were attached to us since birth, holding all of our memories and data in a bubble like sphere. This sphere then goes back to the universal awareness when we die, maintaining the balance as before.

I was experimenting with the Fields when I came upon something most curious - they could be programmed for other uses if properly configured. No matter what anyone thinks or says, all life on earth, as well as other places in the universe, have remnants of the same genetic code. In essence, there are slight differences of course, but these can be overcome with the right know-how (a perfect example would be spiritual programming either with objects or the inner self). Anything can be accomplished if the right steps are taken and anything is possible if we think outside of the box.

One of the many things I have come up with is that the Fields can be programmed with genetic blueprints - memories and genetic data were just the tip of the iceberg. If we programmed our main field to accept sub-fields, or links, we could then correlate between two designated fields - which would then link two forms together in a relationship. This linking is the necessary step into a full physical transformation between two body masses (as in, between human and were-creature, shape-shifter, etc).

Another small fact that I had discovered concerning Morphogenetic Fields was something totally unexpected - after the merging of the physical body with the astral body, creating the intra-body respectfully, our main Morphogenetic Field changes. This change, in turn, allows the Field to become a conductor as well as a basic receptacle for our imprints. With the newfound knowledge of this I set to work, producing the necessary steps to harness this energy.

That is when I realized that when a person shifts, it is necessary for the sub-field to be charged with a current of energy. This energy is needed to transfer Dark Matter for the necessary change in body mass. I had stumbled across a great revelation, the pieces were finally falling together. These pieces are now the building blocks for actual shifting, and I owe it all to POAA.

The three sigils I am going to show you is how the Fields can be charged with the necessary energy. The Sigils are Physical, Astral, Spiritual and Base. All Sigils are a self-replenishing source of the separate energies that they are respectfully named after. It is with this intention that I brought these Sigils to light.

The energy needed to conduct the rituals and make them work properly cannot be generated by the said person alone, the said person needs aid. After time, this will not be the case because the said person will slowly build up on energy, which the body will become a container of sorts and then the sigils are respectfully null and void after the body has made the necessary metamorphosis (butterfly effect. Unless of course, you wish to use the sigils in magickal situations suited to your needs.

5 - The Base Sigil and Containers

Here we are at the Base Sigil and Containers section, a most valuable part that cannot go unnoticed by any means. When the knowledge of the Base Sigil was given to me, I understood right away how important it would be to practitioners, not only for the workings in this book but for all magick works everywhere.

A new means of storing energy was literally dropped into my lap as a gift. This gift would surely reconstruct how energy can be stored for magickal use throughout our world and perhaps revolutionize how we perform rituals and spells altogether. I was not only curious, but amazed at the notion of exactly how much energy could be stored in these sigils. At first the picture was a little blurry, but after seeing first-hand the effects - I was truly left in awe.

As you can see, the Base Sigil is truly unique and very powerful. It can be used to strengthen any spell perfectly, it can be used for a means of protection, and above all else, it can be used to augment any other sigil it comes in contact with - merging, etc. Here is what the Base Sigil looks like by itself in original form:

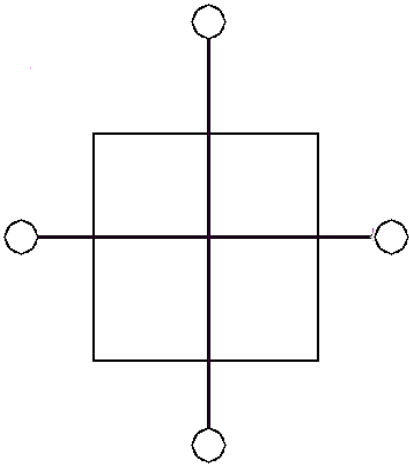

For example, each Sigil can be stored anywhere from one month to six months before it wanes and have same capacity of storing 10 times the amount of energy of one person - which comes to the equivalent of 15 people - truly wondrous. Each Sigil can be charged numerous times and can be stored like any potion or charm if prepared as instructed.

That is where the term 'containers' come in. The Sigils can either be used once, as in a ritual, or they can store energy for you as I explained in the above paragraph - the choice is yours. It is almost like having your own near infinite store of energy at your disposal. Here are the Sigils in their respective categories:

Physical Sigil -

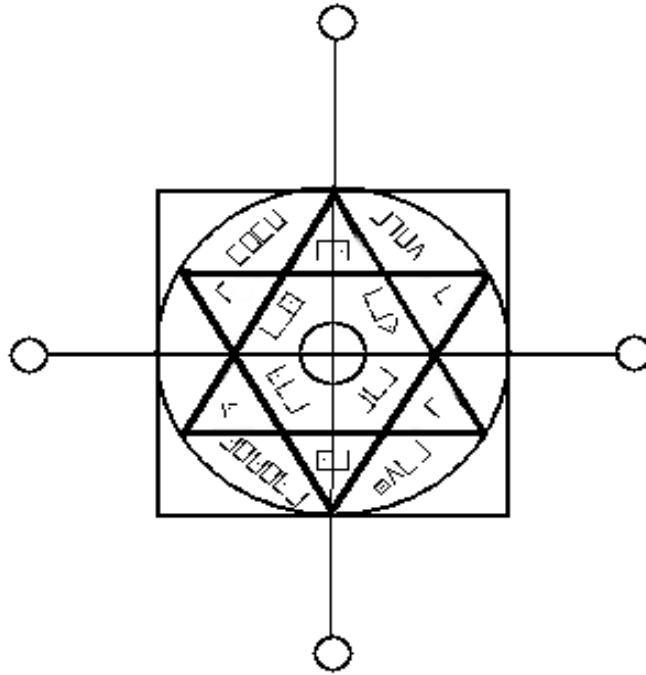

This is the Physical Sigil and Container - this Sigil represents Physical/Prana Energy - or your gross physical energy. It also acts as a container and keeps all energy inside the sigil itself so you can use it whenever you have need of it. You must recharge it once every month if not used for a long period of time. To keep the energy in, cover it with a black cloth, never fold the paper it is on for this will cut the energy of the sigil and it will not be of any use afterwards. Draw this sigil on a white piece of paper using a charcoal stick.

Astral Sigil -

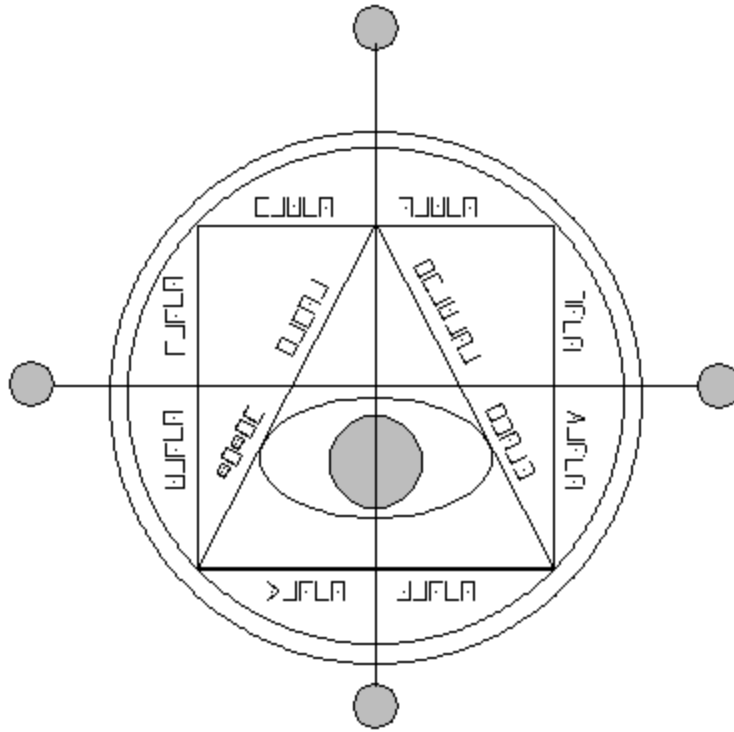

This is the Astral Sigil and Container used to keep Astral Energy. It is necessary to use this sigil because it will generate more Astral Energy than any human on earth could ever hope to radiate. You can reuse this sigil over and over - and, it acts as a conductor between worlds to open gates that a normal human host cannot ever hope to achieve. This sigil has been one of my best creations for magickal works. Draw this sigil on a black piece of paper using a white drawing tool.

Spiritual Sigil -

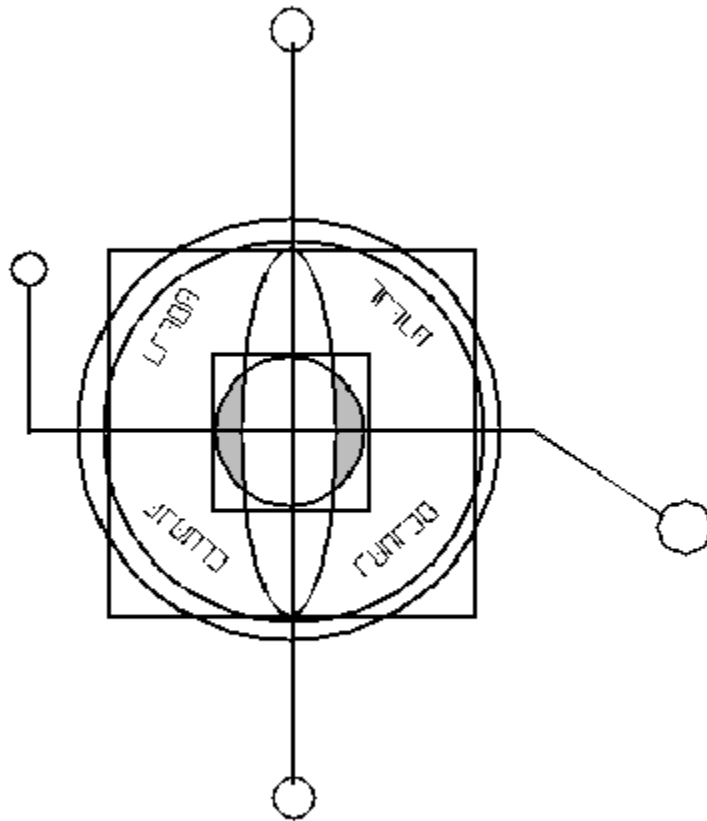

This is the Spiritual Sigil and Container. It keeps all Spiritual Energy and never drains. This is used for a connection to the spirit world, which allows a separate gate to be opened than that of the Astral Gate. It is also used to draw Spirits to you such as your Animal Spirit.

This sigil can be very dangerous if used in an unsafe manner. It must be covered whenever it is not in use by a black cloth- the reason is this, it can open doorways or cause spacial rips to the Spirit world and can let things you do not want into our physical world. Keep it safe and respect it - if you don't, well, it would be very bad, trust me. Draw this sigil on a white piece of paper using a blue drawing tool.

6 - The Element of Shadow/Dark Matter

The Element of Shadow has been a mystery to all, rumored to be a figment of our imagination and kept secret for many countless years - but, no more. Everyone knows that Spirit is the center of everything - it's light touches everything and acts as a balance making everything blissful.

There is only one problem with that - with light comes dark. Everything must be balanced or it would never be called a balance. With good comes evil, with light there is dark, with love there is hate and so on. Spirit is the center, but only the light center and thus you have Shadow as the dark center of the Elemental Wheel.

A lot of people might not actually be aware of this fact but, the Element of Shadow produces an Astral Substance called Dark Matter - 90% of the Universe is made up of Dark Matter in which our own science refers it to super-particles or the lowest vibrations of the super-string.

It is with the merging of the Astral Body and the Physical Body that the possibility of tapping into the Element of Shadow becomes reality. I have been warned many times over that this process is more than just dangerous, it can be deadly. I know what you are thinking - why try it if it is so deadly?

One reason - the greatest risk is never taking one. Where would the world be if we never took risks? I think we would still be in the dark ages, huddled in a corner and still fearing the heavens to be a giant monster waiting to swallow us up. Some of the greatest minds made theories that everyone laughed at - guess what? Those same ideas that everyone scoffed at became sound theories - the men and women who came up with the ideas were later coined as geniuses and the greatest minds to ever exist.

The point is, in order for a person to actually become a were-creature or shape-shifter, they have to tap into the Element of Shadow and the only way to accomplish this is to merge the Astral and physical body. There is no other alternative and no other means - end of story. It is the end result of the merging, the intra-body, that allows the said person (along with the Morphogenetic Field) that draws the Astral substance known as Dark Matter.

The Dark Matter, along with the aid of the Morphogenetic Fields and Sub-Field(s), that draws enough to correlate the required Mass between the two respected forms (Were-creature to Human/vice versa and Shape-changer forms to human/vice versa). It is also noted that the Mental Key Thought is the triggering effect between forms for either choice.

The Mental Key Thought triggers the change, acting as a switch in the Fields. This is necessary to change, even though emotions sometimes trigger sporadic changes as a side-effect of the Key Thought Process. Practicing the meditations as I have listed in the other chapters will help curb these sporadic changes. If not controlled, the bestial nature of your phenotype will take over in the end. This cannot and will not be allowed - that is why you must take the meditations seriously - never underestimate your animal, even though it is one with you, it is never tame.

Shadow In Correlation With Dark Matter -

Figure 1: the Elements of Shadow and Spirit are interlocking counterparts, together they function as a central nervous system that balances out the universe as should be. Below is the diagram I have made to show you where Shadow fits into the Elemental Grid:

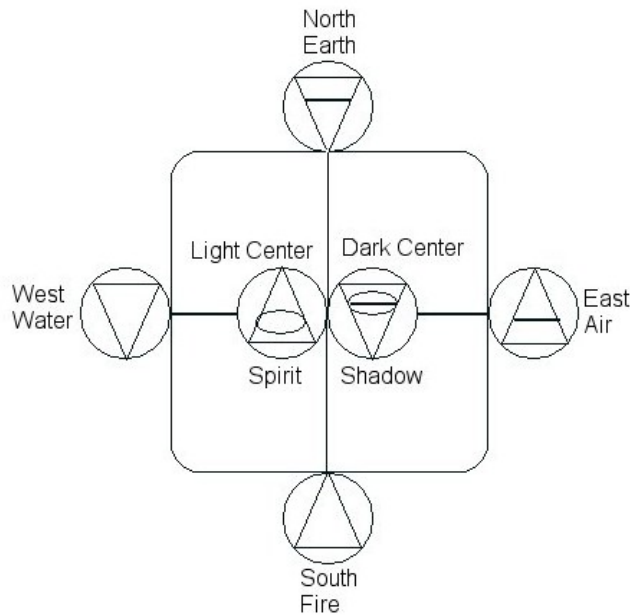

Since Shadow creates the astral substance called Dark Matter which allows one to change their body mass (shape shifting), this is where the use of Morphogenetic Fields enters the equation and completes the formula. When transforming from one form to the next, Shadow either draws from the Dark Matter or replaces it, creating the perfect balance between the physical and astral that is needed for this change to happen while the Morphogenetic Fields act as the memory container to hold the dark matter in place (i.e, compound container) and acting as the memory banks of each form (phenotype/human figures).

For example, when a person is six foot and then changes into an 8 foot creature, the person in question borrows the necessary mass from the Dark Matter to make that physical change possible. Without this relationship, all ethics on shape-changing could not exist. No matter what, this balance must be met, it is a rule that cannot be altered.

Everything and everyone (including the other Elements) is touched by this Dark Matter made by the Element of Shadow, just as they are equally touched by the Element of Spirit. Before I had summoned Asmodai, Paimon, Amon, Oriens, and Mobloch, I had no idea that such an Element existed, let alone that Shadow could produce this Dark Matter they spoke of. The problem is, the only way to access the Dark Matter is to merge the physical body with the astral body (that takes some dedication and patience).

At first glance, I thought that the demons were lying to me just to be spiteful as demons can be at times. I was curious, so I agreed to the deal and it was then that they began transferring the necessary knowledge into my head to show me how it was all possible. After I had written the information down, I had only one step left to perform. That last step was to make sure that the information was correct because I hated the idea of being swindled, even by demons.

Don't get me wrong, the thought of it all is very interesting, but there is definitely a price for the abilities stated. I will not sugar-coat any information and will be totally honest when I say that it is not easy. For the first year, the said person will experience blackouts during the transmogrification. They will not remember what has happened and I mean nothing. There will be pain beyond words, the actual feeling of it all when it first starts cannot ever be described.

No matter how hard I try and think about explaining the experiences in terms that your mind could wrap around, I fail. I tried explaining such emotions, senses, and other experiences but it was very difficult and the words could not come as easily as I thought it should. I would have to say that I will not envy anyone in the first year stage because it is in truth. I hated it.

The setbacks are as follows: experiencing mood swings, depression, migraines from time to time, sexual urges, vomiting, a voracious appetite (for actual food, not human flesh) to make up the necessary energy lost in the person's fluctuation of mass that occurs because of the constant shifting, disorientation, and numerous black outs.

The benefits are as follows: almost super strength, unnatural agility and speed, being given a total of eight senses that would put any animal to shame, very unique healing abilities, and I am not certain yet, but possibly a very much longer life-span (still experiencing that).

To this day I am still trying to learn how to control the changes, which is very difficult and time consuming (but very necessary for my development). I have personally realized that there is no margin for error when it comes to some of the thoughts and feelings that go through your mind, you must keep all emotions in check at all times or suffer the consequences.

I personally feel that it is on the same line as a nicotine fit, when you crave something and cannot have it. I am telling you, it makes a person go crazy and nothing can stop the shakes. Another side effect is caused by the merging of the two bodies, resulting in hallucinations, temporary insanity, and paranoia, but eventually they will simmer down to almost non-existent.

In the first three months of my finishing the rituals, I had noticed things that were not present before the merging of my physical and astral body. I heard voices, seen apparitions, and had many nightmares involving very weird things. Most of my natural abilities were magnified.

One dream in particular was that I was walking along the edge of this giant forest, there were shade-like things scrambling around among the trees calling my name. I could never see the actual appearance of the shades, but I could

see them in flashes. I could feel them watching me and hear them speaking in gibberish. This dream continued on, over and over, for about three to four months and for the life of me I couldn't figure it out.

I tried going toward the forest and confronting the shades, but as I moved closer to the rim my legs would freeze and I couldn't go any further. I would then wake up, sweating, and on the verge of screaming. The whole thing is a very negative psychological episode that I wish could be undone. Sadly, it continues on and on to this very day.

One night, as I was dreaming the same dream again, this time a woman came out of the forest and started talking to me (she had hair and eyes that were silver). When she came near me I could move this time. She embraced me, followed by both of us shifting, and then running into the woods. Every dream after that was good, no more nightmares.

Now I dream mostly of what I am when I change, running around and feeling free. I truly believe that it was my patience, determination to succeed, strong will (mind/spirit) that had seen me through what I call the transition period. One must be able to cope and adapt through this period, remaining strong in spirit and mind if they hope to achieve the full effect of the transmogrification. I cannot say what would happen if a person didn't come out of this state, I would probably guess that they would slowly go insane, resulting in the same fate when you open your third eye artificially.

Take note though, all will be well if you commit yourself to the information in this book. There are no cutting corners and no fast way to accomplish anything. You must do as this book says in order for you to complete the necessary requirements or else the consequences will indeed be very bad. I would hate to think about what would happen if your phenotype takes over.

The end result of that situation could spell a fate worse than death for the person who ignores my words. Trust me when I say that society will not look very kindly upon a monster, and everything is considered a monster when fear strikes the heart. I guarantee that the situation will consist of a 'shoot first and ask questions later' scenario if that should happen. Besides that, the government would probably dissect you in a lab thinking you are the missing link to human evolution.

Chapter 2: Beginning Methods

Meditation Methods For Preparing the Body (Breakdown):

This chapter is the beginning of a very long road to where you want to end up as far as preparation is concerned. If you read this chapter carefully and commit to heart what it has to say, you will very likely do fine and your dream of shape shifting will come true (or become a Vampier if that is the desire).

I know that patience is a very aloof virtue, not very many have it to begin with and it is much more elusive with age. This is the part where I will tell you that patience, dedication, and above all else, determination, will come into play. Without these qualities, either gained or instilled already, you will get very frustrated fast. Not to worry though, if your goals are in this book then you will most certainly master them with no doubts on my end.

Opening The Third Eye

The first section of this chapter deals with opening the third eye and is very important. I don't know if I have to explain myself for this, but here goes anyway. The third eye is beneficial to anyone, it connects the lower self with the higher self, thus when this relationship occurs it bridges a mighty gap between reality and illusion reality. Illusion reality is what we think exists and is what has been taught to us since we have been born - while true reality, or base reality, is what is actual in every dimension and not learned but experienced first-hand when the third eye is finally open (not artificially either).

The difference between opening the third eye properly and artificially is this - 'properly' means opening naturally or without harm, while 'artificially' means forcing the eye open instantly. The result of opening the third eye 'artificially' is that you can harm yourself not only mentally, but physically as well. Some effects will cause mental disorders such as delusions, insanity, paranoia - the list is a long one indeed. If you do not think this can happen then you are on your own. A little note though from personal experience - I have seen it happen before and have seen a few friends end up in the padded room all dressed up and nowhere to go.

Creating Morphogenetic Sub-Fields

Sometimes things cannot be explained by pure rational science, there is only a 3rd of things out there that can be dealt with what we know by applied scientific facts. I have been told that I was wrong about Morphogenetic Fields and have been ridiculed much since the introduction of my finds concerning the Fields in general. I will briefly say this - it is my thoughts and opinions that people who claim they know everything in essence do not and overstep their bounds when they criticize people who do. When I promote something, it is not with grandeur, it is with merit. I research everything and then research it over again many times before I ever claim something. Do not fall victim to those who think that their ways are right, trust yourself and trust your own paths, not predestined ones by dull thinking drones.

To create a sub-field may seem impossible, but in truth it is fairly easy and some of you have already accomplished this without your knowledge. We create sub-fields when we are trying to be different - many people out there who claim to have animal spirits residing in them or what not are actually harboring a Morphogenetic Sub-field of their own. They create it, they live it, and they even experience the numerous phantom shifts that result from the creation of these fields many times in their lives. The only problem is, not many people can explain what it is that has been happening to them so they concoct terms that will better suit their feelings and experiences, such as the term 'phantom shift.'

Technically, any Field that is not in normal aspect of the main Morphogenetic Field is basically a Sub-field. The normal aspects of a Morphogenetic field are what we experience in our daily lives such as emotions, situations, life experiences, thoughts, decisions we make, adaptation, consequences for decisions, etc. All abnormal aspects would be other outlooks such as the occult, paranormal, or anything else that does not fit in the normal everyday lifestyle laid out before us.

In respect, I am not a normal person. This is assumed because I am writing this book for one. No normal person would ever even dream of writing a book like this. For two, I have summoned every type of entity or whatever since I was very little and still do. In the eyes of our creator this is neither wrong nor right, it is one more material

color he can absorb at the end of my path when I rejoin back into His consciousness. So it is for everyone when their path has come to a temporary stop - that is, until they go on to the next duration of experiences. He has given us the means to access whatever we will but, in the end, everything we do or say reflects back on us in the final download.

The sub-fields are here for us, but we never realize that they exist for us to create and use. I admit, summoning demons might have been a very bold choice to get the knowledge I had been seeking, but it turned out to be more beneficial than I could ever express in words. Certain people will often go out of their way to put a person down for doing it or make their life miserable because of the fact, saying that demons and such are an abysmal waste of time, but we will know the truth (you and I) and they will be left still wondering.

Method One: Opening the Third Eye

1st Level Meditation

For the first week you will perform the following meditation twice a day, once in the morning and once at night. It shall be done in a room or place with no distractions and very little or no traffic (traffic as in, other people, or negative influences - energy or otherwise). Before each practice you must perform a cleansing of your area. This is necessary because you will not want any type of influence in your place besides what you are trying to generate.

Begin by sitting Indian style, back straight, arms loose with palms on lap facing upward (as if receiving). You will close your eyes and think of nothing - if by chance thoughts or emotions shine their ugly heads, dismiss them as much as possible (you might have to start over if these thoughts and emotions are too overwhelming). The longer that you cannot suppress the occasional thoughts and emotions will be a sign that you need more work in this area.

With eyes closed, concentrate on the darkness behind the eyelids, focus all of your attention on this darkness. Breathe normal for a few minutes and continue your focus. Notice how the breath escapes the lungs, the rise and fall of your chest, feeling more aware with every breath, relaxed.

Even though you might not realize it at the present time, this will be most beneficial in the long run for the next two levels of meditation concerning opening the third eye. After a few minutes, when all is quiet within the mind and otherwise, begin breathing now by first inhaling deeply through the nose, and exhaling deeply through the mouth. Continue this for a few more minutes with a clear mind. Now begin inhaling through the nose for a count of four, hold for two, and exhaling out the mouth for a count of four. Continue this process until you are fully relaxed, the mind is clear and obstacle free, and all is peaceful.

It is this state of being that you will try to accomplish for in the following week, the so-called goal of this exercise. Clearing the mind and keeping it clear will benefit your advance in the levels when the time comes. It would also be wise to stay away from all caffeine, nicotine, alcohol, eating (a half hour before), or any other drug that inhibits a false sense of temporary awareness. These kinds of things stimulants will never bring you closer to your goal no matter how much you think they will. In fact, they will only hinder your success and advancement and put you farther from your goals in this matter.

I also advise you to drink plenty of water, not too much though, because the element of water will purify your body and mind. A clean body and mind will most definitely lead you down the path of awareness faster and with a much higher success rate. Taking a shower before the meditations will also be beneficial towards your goals because you are in the motion of washing away all the negativity you have accumulated during the day (this includes stray energies from other people as well).

Lighting incense during your meditations will enhance the effect as well like dragons blood, Dittany of Crete, or Pine. It is only a suggestion, but the incense made by Tommy Hilfiger produces some very interesting effects when it comes to meditation (my secret to you). I know it is very shocking, but you can guess what I was thinking when I found this fact out by accident. The effects were very dramatic and boosted the effect by half of what I could normally do (and that is quite the boost by all means).

On to the next level of meditation ...

2nd Level Meditation

Now that you are ready for the second level of meditation, it is now that you will begin a few more techniques added on to the original first level of meditation. The second level of meditation is to increase your awareness, not only the inner perspective but the outer perspective as well. Think of this level as the connector between yourself and your third eye awareness, the middle ground so to speak.

You will begin as before in the first step, sit cross-legged, arms loose and palms facing upward on the lap. You will clear the mind, breathing normal for a few minutes, then into the concentrated breathing - inhaling through the nose for a count of four, holding for two, then exhaling through the mouth for a count of four. Continue this method of breathing for at least 10 minutes.

When you are totally calm and focused, imagine now that a warm golden light is pouring over you from above your head. Feel its warmth gently going down to your shoulders, then to your chest, then down to your lap, and finally down to the ground. You should also feel a slight magnetic pull in the middle of your palms like a weight. All of that positive energy will give off a faint glow and your palms will be able to pick it up.

As you are now in your protective bubble, make up some words to assure your lower self that you are protected and safe. Otherwise, you can say these words: I am protected, my body is completely safe inside my space. Try to reach out with your awareness by observing the room you are in (with your eyes closed). Explore as much as you can through your mind. This will allow your third eye to work and become accustomed to taking on tasks. You can also ask questions and find out what your third eye has to say. Communicating with your third eye is another level of developing your awareness and assuring the third eye that you want it to take part in every day things such as problem solving.

On to your awareness

3rd Level Meditation

Now it is time for you to take part in the third level of meditation for opening the third eye.

This is the last level that you will have to complete to fully open the third eye. It is the opening of the doorway between worlds, space and time, and most importantly, the key to all illumination. You will no longer need to rely on divination or other arbitrary means of getting answers. Not only will your psychic awareness amplify, but many other opportunities will indeed present themselves to you over time.

What you will be required of ...

The following list is what I will use for guidelines. Each person needs to take responsibility for their own well being, and in that effect can be used to make yourself feel better or healthier and doesn't have to be used for just opening the third eye.

Preparations for practice

- Any clean quiet room free from disturbances is advised.
- There needs to be adequate light to view the meditation aid.
- Each practice session will normally require between 20-30 minutes, depending upon your level of commitment and circumstances (five to ten for the beginner).
- Wear clothing that will not restrict blood flow.
- You may choose to have something to regulate your meditation time.
- You may also choose to have a note pad or journal close by to record your experiences.
- Please do not discuss your experiences with others as this may:
 1. Extinguish your vital energies that are needed.
 2. Give a false sense of accomplishment.
 3. The mind can assist or distract a person from their progress. If your mind gets distracted you will miss out on many things of importance.

The people with whom you share may not value what you experience and undermine your progress.

4. You may frighten those you tell, and they may treat you accordingly to their beliefs.
5. They may try and practice the exercises without fully committing themselves to adequate practice and safety.

• Please note that although the third eye will open if you practice the techniques outlined and described shortly, please do not ever try to anticipate results. Anticipation leads to misdirection of focus and hence a distortion of your true goals.

The meditation Aid

As I see it, the ancients did not make clear their mystical practices, and placed their teachings in metaphorical riddles. Many of these forms are in pictorial form referred to as Mandalas. The problem with many Mandalas is that they tell a story, as opposed to doing a specific esoteric task.

I am going to unlock one of these riddles for you. Now the riddle is very simple, and my answer to constructing the meditation tool is in itself very simple. It is this simplicity that will be both the agent of change and the vehicle through which you will have an experience.

- You are going to make a meditation aid that will over time have the effect of altering the direction in which your third eye is at the moment, and the reason why you have lacked clairvoyant experiences. You are going to make an esoteric and magickal mandala.
- You are going to make a mandala that will cause as a result of natural law, your third eye to invert and open fully.
- The meditation tool will cost no more than \$9, but will require you to be careful when making it.

Making the meditation aid

The meditation aid consists of:

1. A white piece of card (card is preferable to thin paper).
2. A smaller square piece of black card placed centrally on to the white card.

Important details.

The white card must be:

- As neutrally white as possible.
- Have a mat finish.
- Texture is smooth as possible.
- It must be free from creases or blemishes.
- It must be large, 37 inches across L x W.

The black card must be:

- As neutrally black as possible.
- Have a mat finish.
- Texturally smooth as possible.
- It must be free from creases or blemishes or evidence of adhesive (used to secure it to the white card).
- It must be as square as possible. The edges must be true and straight.
- The sides should have dimensions of 3.5 by 3.5 inches.

Explanations

- The white card has to be large, because you need to be able to sit in front of it and not be able to see the sides of it very easily. This helps the mandala dominate your visual fields and prevents your mind from wandering all over the place.
- The crispness of color and texture are important. When meditating for more than a few seconds, most people's concentration wavers. The mind has been conditioned to be active and 'move about', collecting and gathering information and then assessing it. These processes are automatic and incredibly fast.
- However, when you are attempting to open the third eye, you are temporally suspending normal habitual

processes so that you might discover something 'normally' hidden. Unless the cards are without much description, your mind after a couple of minutes will look for anything about the card to get fixated on, and hence be distracted from the main exercise. Such distractions will decrease the efficacy of the method.

With appropriate care, a reliable and effective mandala can be easily made, such as the one shown in the following picture. Mandala, white background with black square.

Mandala Outlook

The picture below is what the mandala should look like. Notice how the black square is directly in the middle of the white board. One thing that you might never have known if not said, is that the black square is actually the doorway to your third eye. In the black square is the space occupied by the third eye, now dormant, and is awaiting to be stirred. Many things will happen in that black square and with the proper instruction from you, will serve to open the doorway that is blocking the eye's development.

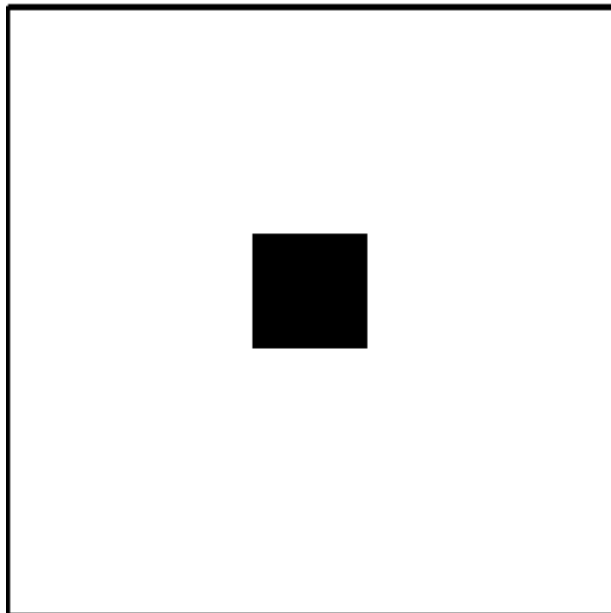

Meditation

Meditation is an age-old practice of quieting and focusing the mind. Any of you that have tried meditation will know that normally the mind does not like being still or particularly focused. Some of you will struggle to meditate and others of you will have little difficulty. All I ask of you that you persevere for at least of couple of weeks, and longer - preferably.

There are just six steps that you must do in order to open your third eye **safely**.

1. Enter a relaxed state of mind.
2. Meditate on that which will open your third eye.
3. Contemplate what has occurred, recording information in a journal.
4. Relaxation technique.
5. Visualization for balance and protection.
6. Become grounded.

Preliminary Considerations

You should find yourself sitting comfortably in a place where you will be free from disturbances and distractions. You should not have eaten for at least an hour. You may have had a drink, but should not have drunk tea or coffee for at least an hour before, though fruit juices or water are fine.

This preparation is very important because you do not want your attention going to places other than where you decide. If you are feeling hyper due to consumption of stimulants, then that will be a waste of your time because you will not be able to perform the following exercises easily.

The 6-steps to Opening the third eye safely.

1. Start of your meditation always with a settling down, and quieting the mind exercise. This will involve using a basic breathing exercise-or basic prana as it can be referred to in certain circles. Do this for at least 5 minutes. (Inhale through nose a count of 4, hold 2, exhale through mouth for a count of 4).

2. Meditate using the mandala initially for 10 minutes. There will be a temptation to want to use it for longer periods. However you need to allow time for your mind to psychologically get used to looking at a plain piece of white card with a black square on it.

This sounds simple, and you may think I am being over protective- but I am asking you to pay attention as best you can for 10 minutes on the mandala. After a few days you may wish to increase the duration of the exercise by an additional 2-3-minutes a day until you reach a total of 30 minutes. Some of you may wish to increase the duration over 30 minutes if experience permits you.

3. When it is time to finish meditating on the mandala, close your eyes, and mentally allow yourself to go over the experiences that you had. Did you see any colors, shapes, hear sounds, felt heat, pressure etc? Record the information you have acquired in your journal. By recording your experiences in a journal, you will be able to record your progress more clearly and have a greater insight into what has happened, as you reflect on your progress at a later time.

4. Perform a relaxation exercise with your eyes closed. I recommend slow deep abdominal breathing-as in the first step. Perform the relaxation exercise for at least 5 minutes.

5. Visualization for balance and protection.

6. Before you open your eyes, be aware of the movement of your chest, can you hear the sound of your own heartbeat? Can you feel the ground supporting your weight? Then shift your awareness from the inside to the outside.

Can you hear familiar sounds in your home or place of practice? Can you hear the birds, or the sound of a vehicle? Bring your attention back to the room. The end of that sessions practice. All in all, you will certainly reach the goal you desire at the end of this practice if performed accordingly. Remember to ground yourself properly because excess energy needs to be controlled.

Method Two: Creation Of Sub-fields

1st Step : Alteration

This chapter will explain the meditation methods needed to prepare the body for the upcoming rituals, future shape shifting abilities, and Vampir transformation by creating the necessary and valuable Morphogenetic & Sub-Fields (creating new ones and adding onto the original). It is definitely one of the necessary fundamentals that you should commit to memory. In the long run, this type of thinking will help you deal with your apparent phase shifts that occur on a daily basis when becoming one of the beings listed in this book.

The first part we will talk about is on the topic of Morphogenetic Fields. Morphogenetic fields are basically the non-physical blueprints that give birth to forms existing outside the normal boundaries of our physical reality. According to its founder, the biologist Rupert Sheldrake, a morphogenetic field, is an equivalent to an electromagnetic field that carries information only, not energy, and are available throughout time and space without any loss of intensity after they have been created.

This might have been the case if not for further exploring these fields in which I have discovered that they can be transformed and molded for other uses like shape-shifting and merging certain entities with our physical bodies. In essence, what we are accomplishing is called a phase shift in which the physical body undergoes a subtle transformation in the boundaries between the dimensions of reality. The transformation that occurs creates a bubble or ripple in the space time accordance and leaves the signature or energy mass of the said individual in a state of suspended animation (not literally) in which the natural physical laws do not apply.

It is a fact that Morphogenetic fields are created by the patterns of physical forms (human, animal, plant, etc) which is why we can alter them by thought form suggestions, meditation, and energy forming techniques. It is by this type of programming by the said individual that we can tap into the energy fields and use them for the purposes of altering our own energy blueprints into something else by thought. The Morphogenetic Fields will help guide the exact formation (shape shifting etc), and thus mold the Shadow's Dark Matter allowing us the ability to temporarily change

our normal signature into a different signature.

Our initial system called the energy/mass signature already has within it what is called a 'seed' or 'blue pearl' in which our essence as a whole lies, our own genetic blueprint. When this 'seed' is tuned in to another that resonates with a similar 'seed', it is then that it can be changed, allowing our physical body to make the same change as the other energy signature (phenotype) with help from the Dark Matter that is created by the Element of Shadow. The Morphogenetic Fields act as an astral memory bank that holds onto both blueprints (phenotype and human), acting as a generator between the two.

(*Note: The Blue Pearl or Seed is not to be confused with the Eastern Beliefs like Shaktananda. It is the same principle but it is not the whole of the soul. My belief is that people are limited to only one perception of things and in that much information is left out for fear of misuse).

When the change is triggered, the Field generates the blueprint of the phenotype in which the human shape is then transformed, and vice versa. When the Field is processing from one shape to the next, it is then that that it draws from the Dark Matter of Shadow, which then makes up the mass/energy flux between the two shapes, creating or depleting when necessary, and balancing the slack, so to speak.

Morphogenetic Fields are in direct link with the sub-atomic consciousness of everything and can be used to describe how the human consciousness can be shared with that of the Astral Animal Spirit you will be summoning. This technique can be used for all three Rituals concerning the Were, Shapeshifter, and Vampier, but I only recommend using this practice on the first two.

*** NOTE:** *This warning goes into effect because doing this with the Servitor Entity for the Vampier can also develop into an evil possession, if not properly checked, and would defeat the purpose of which you intended. Therefore, instead of merging with the Servitor Entity you would only serve as a pawn and have no will of your own.*

Because the Fields play a part of the main role in this process, it is the idea that humans, in due process, can go through this dramatic collective shift not only in the physical aspect, but the spiritual and astral aspect as well. A shift that will in fact happen when the Dark Matter (mass) needed for the shift is reached.

In other words, when a certain amount of build-up from the Element of Shadow can be produced into Dark Matter, it then triggers the necessary energy needed for the change, and stays fluent by the aid from the Fields created by the individual set for this purpose from the beginning. This may have been the reason why legend states that a person can only change on a full moon - even if it is myth, this would truly tie in for the energy build-up stasis.

Alteration Method 1 : Preparation

I know that many of you who are interested in any kind of shape-shifting know about phantom shifting and the like, but we are not going to go into that type of meditation for the exercise at hand. Here we are going to begin the process or steps that involve preparing your subconscious to accept your phenotype or animal forms before creating the Sub-Field or Fields depending on the choice you have made regarding the shape-changer or were-creature respectfully.

This process is not as important but it sets the wheels in motion prior to the Sub-Field creation step and in my opinion to be prepared is to be ready to continue onto the next path. Furthermore, I would hope that this technique would be your stepping stone to a stronger visualization tool when the time comes to create the necessary Sub-Field or Fields.

Beginning:

Let us begin by gathering all of the visual aids you will need for whatever Spirit Animal you will choose to call. It can be pictures, watching video feeds, having statues or other representations, or other collectibles that will further help you on this path. You must literally breathe and sleep into this awareness of the specific Animal Spirit. If you are unsure to what Animal Spirit would be your inner calling I have listed a ritual that will help you along the way for those who are curious to see what lies inside.

The said ritual below will allow you to see/find your inner animal and is most beneficial to those who have no clue, have a connection with an animal and just want to make sure it is the right one, or are struggling with which path to choose internally.

***Note:** Just to be sure we are straight from where I get my sources, I want you to know that I had to do the same thing when performing my studies for conjuration lesson nine which dealt specifically with Shamanic Invocation. It was necessary for me, as the student, to think outside the box and create my own Invocation process to pass the said lesson so I came up with this one and it worked perfectly, more so than I thought would be possible.

Finding Your Spirit Animal

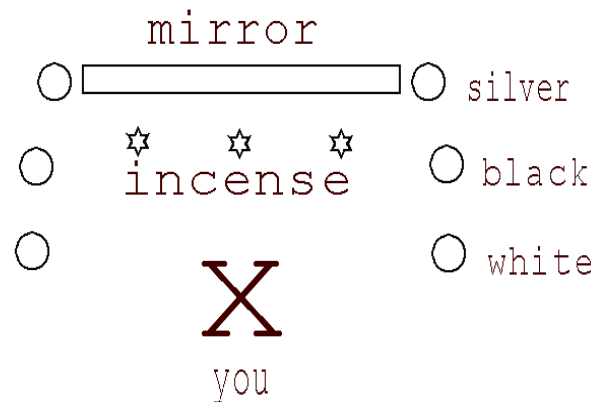

Using a mirror to find your animal spirit.

The mirror shall be 4' L x 3' W, or a mirror you can see your whole body when you are sitting. Have two black candles, two white candles, and two silver candles.

The two silver will be placed on the sides of the mirror and represent the astral connection between you and your spirit animal.

The two black candles will be placed 4 inches from the silver and represent the protection against and banishment of negative energies that might try to escape from the lower regions of the astral wilderness during the ritual.

The white candles will be placed 2 inches from the black candles which represent the kinship/relationship between you and your animal spirit and also promotes positive energy during the ritual.

You must be approximately 32 inches away from the mirror at all times during the ritual except when doing the calling (mark the spot with tape or whatever so you will know exactly where to be). Do not touch the glass of the mirror at any time during the ritual before or after the calling.

You can and may burn incense during the ritual if you wish. Any of the following can be helpful to make contact/view what spirit animal you are most akin to - Dittany of Crete, Sandalwood (white or red), Pine (forest), or Myrrh.

If you decide to mix the smoke from Myrrh and Sandalwood, or Dittany of Crete with Myrrh it would be most wise to prepare yourself with the most vivid vision of your life. You will not only see your spirit animal, but you will be able to ask them to bond with you very strongly.

THE CLEANISNG

Perform a cleansing of the area by burning sage or other cleansing incense making sure nothing can harm you or prevent you from completing your task at hand.

While holding the incense make two rounds of the room you will be performing the ritual thinking clearly and positively. Speak words of protection or say that the room is no longer in danger, the room is only filled with love and trust, the protection is strong, or whatever you may wish to come up with. You must believe in your heart and mind that the room is protected and both you and your spirit animal will be safe - the subconscious mind is very strong.

Face north and make the sign for Earth, face South and make the Sign for Fire, face East and make the sign for Air, face west and make the sign for Water. Ring a bell once for each direction speaking the name of of each element's ruler after you have made the sign.

(Another note: In my book Il Libro Della Magia, I go further into detail on Elemental magick, Invocation of, Evocation of, Illumination of, Rituals of, incantations and everything else you would need to start out in Elemental Magick).

Light the two silver candles first saying each time:

"The gate shall open so that I may find my spirit animal. Animal spirit hear me."

Light the two black candles second saying each time:

"No harm shall come to me or my spirit animal in this hour. We are protected as one, as our souls are one. Our wills make it so, so shall it be."

Light the white candles last saying each time:

"Blessed is our union, the gate is now open, show me my path that I must follow. I humbly ask my Animal Spirit to come. Hear me, Brother/Sister and come."

Sit cross-legged in front of the mirror with eyes closed, palms on knees facing upward, as if receiving. (it is advised to wear loose clothing).

Inhale through the nose for a count of six seconds, hold for a count of two seconds, exhale through the mouth for a count of six seconds.

Repeat this until you are relaxed and very calm, with no invading/distracting thoughts or emotions of any kind (if you do, you will have to start over again from the beginning - usually waiting an hour between times). Also known as 'Clearing the Mind technique.'

The calling

Open your eyes and focus intently on the mirror, get up and kneel before the mirror so that you may place both palms on the mirror in the middle - this is to insure success of opening the gate between this world and the astral wilderness where your spirit animal lies.

Speak these three words only once as you are touching the mirror -

Alohawa (ay-low-hah-way)
Iamra (ee-ay-mm-ray)
Mekut (meh-koot).

These words create an energy resonance which allows the gate to open using your own energy.

Sit back down cross-legged with your palms facing upward, focus on the mirror once again, chanting (whispering) Come! You will see the vision of what your spirit animal truly is. This will indeed start the Illumination process and hopefully make you more aware of what you could be later down the road. Even though this method will not be enough to merge you with the animal as of yet, but it will make what we will discuss later in the book easier to follow.

Another note of significance, please perform a banishing after this is done to ensure your own safety and to make certain that nothing negative came to you during the Invocation. Also as a definite reminder that when you go to bed you should have a dream of the same animal and may even speak with it - it will not be an actual dream, per say, but an encounter on the astral plane, so be careful in thinking it to be an actual dream sequence.

2nd Step : Correlation

How To Create Your Morphogenetic Sub-Field

In this section I am going to explain how to create your own Morphogenetic Field/sub-field, which will harbor the phenotype blueprint and your own blueprint. The relationship between the two is necessary so that the Field will remember for you how to change between the two bodies.

Sometimes when in phenotype form, the human mind will either forget or lack the ability to shift back, in which the Field and sub-field acts as a generator in the human mind's stead. It would be on the same basis as a mental switch that is used in some mind programming methods, or a relay switch in most methods of memory triggering.

We will begin by adding onto your already existing Morphogenetic Field with the sub-field. Even though we already have one attached to us, it is necessary to add the

genetic blueprint information concerning the phenotype desired to ready the physical shifting that will take place in the third ritual. This act is creating a differential in the field which the end result is called the sub-field.

Step 1 - Determining Your Animal Spirit

As discussed prior to this section, you can either just choose an animal that you feel akin to, or you can perform the ritual to find out what animal spirit you are actually harboring inside of you. Either way is neither right nor wrong and it really doesn't matter which path you choose to follow. If any person knows which animal you belong to, it is definitely yourself. No one can tell you what you are or are not because that is something sacred to only you.

As far as mixed breeds and whatever else that people have concocted for groups and boards on the Internet, that will not hold any ground here. The reason being, if you truly want to create a hybrid animal form prepare yourself for the worst because dark matter is not a friendly force that will say something like "Oh yeah, a dragon and wolf will look really nice together."

No, unfortunately your subconscious does the tallying for you on the astral augmentation of the whole picture. This being said, and being pretty plain, is that you do not want to be some monstrous form that will consume you by having a more powerful will than you do. Wanting to be a dragon (dragon spirits do exist), or such other magickal based creatures might be a fanciful idea, but in the end prove to be your own undoing. They are unpredictable forces that can turn the tide quicker than you can say 'AGLA.'

Alright, so maybe you do want to be a far-fetched creature of unknown origin for some reason, make sure to have any type of visuals that is needed to create a clear picture in your head so as to program your Sub-Field properly. This goes for any type of animal that you have in mind, the more of a mental visualization that has perfect clarity will be of better use than one you cannot envision in your head at all. If you cannot do this, or possess the ability to achieve this operation, do not fret, with time and patience you will be able to get it down pat.

If you do allow your subconscious to choose, I will have to say that your subconscious will distort and pervert what

your perfect picture of your animal in true form should be, and trust me when I say that will not be a good thing in the least, because the subconscious has a very good way of twisting things out of proportion.

Creating the Sub-Field

Step 1 -

In deciding your Spirit Animal, gather as many pictures or visual aids that you will need to memorize mentally everything that is needed to create a clear picture in your head. All of this information is necessary to create the imprint you will need to start the process of creating your Sub-Field and to get the added feel of how your phenotype end result should look, feel and move like in either hybrid form or true animal form when the transformations are complete.

This method will also be included in the forms you will take on as a shape-changer but more animal form than were-creature form (as in, you will look exactly like the animal you are trying to morph into, same body mass and shape as the animal itself). Also, the shape-changer has multiple forms or multiple Sub-Fields where the were-creature only has one set Sub-Field.

Step 2 -

It is now time to surround yourself with all of the visual aids you have acquired. Form around yourself a circle made of energy using your projecting hand or an instrument like a wand or athame. Sit Indian style in the circle and close your eyes, visualize your animal in vivid clarity, see it running, see it moving, see it standing, look into its eyes and see a connection that is stronger than steel itself.

Still sitting with eyes closed, open your third eye and use that awareness to see what your animal looks like in the astral wilderness, pull the animal towards you gently so that it is right in front of you. Although you will not be able to merge with the actual spirit of the animal at this time, it is necessary to draw the representation in to form the Sub-Field with the necessary information to complete this step. In your mind say 'merge', and a soft-glowing sphere should appear in the place of where the animal representation was located.

Grab the sphere now with your hands and pull it to you. Hold it in your hands for a moment and feel its energy course along your palms and fingertips. You might feel an overwhelming surge of energy that will make you experience a sort of disorientation or you might feel sick. Whatever the case, do not open your eyes until you place the orb into your chest region, this will assure you that you are done with the step. After, get up and walk around slowly and stretch your limbs until the feelings go away.

Step 3 -

Last but not least, we are going to make the Mental Thought Key or Trigger. This is the mental switch or relay thought that will provoke you to shift back and forth from animal form to human form or vice versa. The Sub-Field is already programmed with the genetic imprint data it needs to successfully draw the necessary dark matter to make the change between human form and animal form (were-creature and shape-changer alike), but it is also necessary now to create a safety trigger so that you can successfully come back through the transformations (no one would like to be stuck in animal form, trust me).

Open your awareness through the third eye and visually picture yourself in a sphere of golden light. Once surrounded in this sphere of light you will see a word or mental picture. Breathing normal repeat this word or visualize your picture and place it in a safe part that will permeate any darkness. If it is a word you have chosen, repeat it silently over and over until you recognize it glowing in your awareness with a certain light.

If it is a mental picture, I would make choose it to be the likeness of yourself when in human form. Remember, the more you can visualize your key thought trigger, the easier it will be to shift back and forth (not so much to animal form, but it will be necessary when shifting from animal form to human form). If it is a problem to visualize your key thought or mental trigger, write it down on a piece of paper and speak it aloud two to three times a day. If it is a mental picture of something, get a picture of whatever it is and focus on that picture until you can see it clearly in your mind like you were looking at an actual picture of whatever it is.

After a while, when you can voluntarily control yours shifts

like flexing a muscle, you will be able to change back and forth between forms (or multiple forms where concerning the shape-changer) by true will and have no use for the mental trigger any longer. Even though this might take some considerable time, practice and be patient for in the end you will receive the results you have desired for so long.

Method Two: Astral Awareness

It is in this section we are going to accomplish a number of things: 1) control the separation of the astral body from the physical body also known as astral projection and later on, astral travel. 2) I am going to explain in steps how to merge the physical body with the astral body. 3) I am going to explain how to summon astral winds to your advantage. 4) I am going to explain how to create astral shields to protect yourself from the numerous entities that live on the astral planes.

Each category in itself will become very beneficial later on down the road because being aware Astrally forms you and your mind to the specific needs of creating the prepared body as a whole when the time comes to merge the two bodies, astral and physical, to the rebirth of the Intra-body. That is why I believe this section to be just as equally, if not a higher grade, important to the point that you will not get any farther in this book until this section is completed.

Please pay attention to this section, it will be a major factor in evolving the mind and body. It will also determine how much you will advance down the road into the completion of the rituals.

Separation

By now, if you are in this section, you should have awakened your third eye. If not, then it is wise to return to the third eye section once again and complete it for you will find no welcome here and skipping sections is considered cheating and unsafe.

Most individuals know about separation and what it consists of. For those of you who have not had the experience in such matters, let me relate in simple terms. Separation is when your astral body leaves your physical body in either projection or full astral travel mode.

Projection is ok in terms as beginning to delve into the astral world, but it is limited in my opinion because the person can only get so far (limited to this physical world). When astral traveling, the sky is the limit not only because we can cover this world, but we can cover other dimensions, worlds, realities; the past, present, and future; we can experience other celestial beings and that list goes on and on.

I remember a few times when astral traveling that I came upon this outer wall - it was huge. I could never scale it, go around it, and it was impenetrable (or so I had once thought). I asked many beings that were around about the wall and they only referred it as the outer rim. One night, as I was carefully planning to go back I had an idea - what if this so-called outer rim was not actually a wall, but a mental barrier of my own making? What if all I had to do was open my mind more than I had previously?

You see, every mind has it's built in logical limits to what they can and cannot do - that is law. We grow up being taught that certain things are not real when they actually could be and thus our minds become wilted and shallow (one example of this is people who do not believe anything out of normal science can exist). When we program our minds to accept things then it becomes apparent that they can be made that way. We open our awareness to the point where we notice things and can actually accept things for what they truly are.

Sometimes it cannot be helped and people are actually born with the ability to see what it is that others do not see - they are the fortunate ones. It is the individuals who have to bust their asses to become aware that have to deal with all the complexities and misery. They are the ones who have doubts about everything and think that it is all in their heads. They even get coaxed into seeing psychologists and counselors because their parents think something is wrong with them. I know all of this because, in the beginning, when I was very little (about 5 or 6), my parents thought something was wrong with me. They thought I needed help, but as you can see, there is no predetermined help for a psychic child or a child who has other super-abilities.

So in turn, I went through my little trials of psychotherapy, went through tests and more tests, went through emotional and psychological hell, endured every kind of teasing you could imagine from other kids - it was brutal.

But, in the end that is the trial of life. Something we have to accept as fate, perhaps some cosmic teaching of how we should treat others - maybe some time you should look around and see if it is in fact you who are doing those heinous crimes to another? Let me just end this lesson with one important factor towards reaching goals - negative energy begets negative energy, which in point returns to the said individual who has committed the crime. Like I have been told over and over again, you do the crime and karma kicks your ass, so be careful and above all else, be good to others.

Separation Technique #1

Of course and by now, you will have went through the necessary steps of opening the third eye. It is here where you shall use that awareness to further this step of astral separation, as in, the separation of the astral body from the physical body. Here it is where you will feel for the first time the fulfillment of being free and composing your astral vessel. Get ready. Get set. Go!

Step 1

Find a suitable place of well-being, security, and also a spot for a sense of comfort free of all stressful distractions and the like. It is in this place that you will banish all doubts, banish all negative energies by performing a cleansing of the work area, and also make the chosen environment to your personal liking (decorations, etc.). Remember to wear loose clothing and perform some relaxation techniques like clearing the mind. Mentally go to a place where you will not lose any focus on the task at hand. Create the circle of protection around you. Imagine a very strong bubble of golden light surrounding you, filling up the whole circle with the warmth that protection brings.

Step 2

It is now that we shall begin the next step, the relaxing techniques to prepare your body. It is here that you can lay down in the sleeping position or also called the 'dead man's position. You can also sit in a chair or recliner, palms upward and resting easily on the arms, feet planted fully on the floor (for grounding), eyes closed and inhaling through the mouth deeply for a count of five, hold two, and exhale for a count of five, hold for two and then repeat the process as long as possible until fully relaxed.

Step 3

Sitting down, laying down, sitting indian style - what you want to do is try to imagine yourself outside of your body. With your third eye, push outward with your consciousness and emulate vibrations all throughout your body. Make the vibrations so strong that you almost feel numb. With your astral left hand, which is controlled by the subconscious, lift it away from your physical counterpart. Repeat the same for the arms, legs, body, and lastly the head. You will notice that it is far more difficult to separate the astral head from the physical head. The reason for this is because the head represents the strongest bond. The rapport that connects the two heads is almost the same consistency, like an astral glue, if you will.

It will be difficult on the first try, but it will become easier with time and practice. Sometimes, when separation occurs, you feel a sort of disorientation, like a mock vertigo - ignore this and push on.

Step 4

It is now that you will float across from your physical body - it might be a little blinding at first being so close to the body, but that is normal for some. Take a while to notice your physical body and notice your environment. Take mental notes and then write them down in a journal so you will learn from your experiences. You might also experience noises or a wind which is coined 'Astral Winds' and later on in the next section we will discuss the uses for them further.

I also want you to know something that most teachers do not disclose for fear of the students well-being and for appropriate (rule of thumb) safety precautions - you can go anywhere you wish on this world when in astral form and anywhere else you are willing to think of. Do not limit yourself to just our world because there are many worlds, many places, and many levels waiting for you to explore. Almost always think outside of the intended box - to do so will not only further your development but you will know exactly how infinite everything can be. Time and patience are the key virtues in Astral Traveling, so be adventurous, imaginative, and above all else, listen to your heart for where you should go and explore. Although there are many good places out there, there are just as many evil places as well (food for thought).

Summoning Astral Winds

For as long as I can remember I came across some phenomenon when astral traveling. One thing in particular were the sudden gusts of what seemed to be wind - the other thing was the many voices I could hear around me (some were like whispers and others were like shouts. These two things were forever puzzling me and for the life of me - back then when I didn't know hell from a hole in the ground - I could never figure them out. I would always try to get the effects every time I would astral travel, but it never seemed to work for some reason.

With much thought, and mulling over certain ideas, the answers seemed to come to me out of nowhere in particular. What if there was a way to summon the astral winds at will and use them to my advantage? First of all, what use could they actually prove to have and then how could someone actually summon them at will? Two difficult questions that seemed to have no jumping answer.

Well, it just so happened that I had run across someone who did have the answers to my questions. It would only state that it's name was Kaigh - and it shed quite a considerable amount of light on many subjects that were rumbling around in the space I call my brain (remember, when on the Astral Planes, never be afraid to ask questions or talk to others because it could prove to be very fruitful and in your favor).

Anyway, it came to be that the voices were nothing more than the collective thoughts of others (whether they were traveling or not) and Kaigh never went into great detail even though I urged Kaigh to do so. Secondly, the astral winds (coined term) were our own doing. They are the force of thought that can be generated by individuals who have a lot of energy when in astral form. Kaigh went on to say that it is in it's opinion that sometimes the winds are there to tell you that there are doors present and that we may use these winds to carry us to other places. Interesting, huh?

So now we are back to the matters at hand and to the meat and potatoes of this section : Astral Winds. Astral Winds are generated by us and therefore can be used to our advantage. We can summon them at will with practice and determination. We can open gates or doors with these winds

and use them to find them. It is all a matter of thought and directing our will and in essence holds truth.

Here we are at a most important point - I say this because I am going to instruct you on how it will be possible to summon the astral winds at will and use them to your advantage. Impossible you say? Well, you can be the judge and jury of this little section and in the end you will have no doubts to where your respected decision will float (that is a promise I will adamantly stand behind).

Exercise 1

When you have separated the astral body from the physical body I want you to go outside of where you are (for example, if you are in your house or a building, go outside away from your physical body). Once outside and away from the body, concentrate all of your will and energy into the same vibration effect you have when separation occurs. Make the whole of your being experience the vibrations so much so that you feel disoriented at that moment.

Upon this act, you will feel a slight shiver or strong, single jolt through your astral body. Lock onto this jolted feeling and speak one word, out loud and mentally - chassit (pronounced the same way it is spelled). This verbal and mental word will take you to a place that has no bearings (no sense of space or horizon).

Whatever is in your subconscious mind to keep you safe will appear as the landscape for this place. This will be your designated place of summoning the astral winds, so visit here often. You will need the practice in order to learn and get the feel of the winds when the time comes to open the gate between worlds when summoning your Animal Spirit.

Review -

- 1. Separate and vacate presence of physical body.**
- 2. Intentional focus on creation of vibrations.**
- 3. Speak, verbally and mentally, CHASSIT.**
- 4. Enter the designated place as intended.**
- 5. Practice summoning the astral winds at will.**
- 6. Vacate place and return to physical body.**

Remember to be patient, it will take some time for some of you and possibly shorter for others. Do not get frustrated if it does not turn out well at first. Keep optimism at the top of your list and you shall prevail.

Creating Shields

This section will specifically deal with creating shields of protection. There are many protective shields that you can use, whether it is for every day use, magick use, when astral traveling, psychic protection, elemental protection, or any other cause you can think of. If it has a name it exists or can be created by yourself - all you need is the right amount of energy, thought, and visualization for the intended shield at hand.

What I want to deal with in this section is how to create a few different shields that will protect you when the time comes to perform any of the said rituals in this book (which can also be used at any time if you so wish - given that it is the necessary shield at the appropriate time needed). Here I will list a rundown of the different shields I will explain how to create -

1. Physical Shield (to ward off sickness, etc).
2. Astral Shield (to protect when astral traveling).
3. Mental Shield (to protect from mental attacks).
4. Psychic Shield (to prevent psychic attacks).
5. Elemental Shield (to protect with the Elements).
6. Spiritual Shield (to guard against spiritual attacks).

It is with my instruction you will be able to cast your own protective shields at any given time when needed. Quite a few people do not either realize they need shields or have no awareness to their existence. It is here that I will discuss the most important of the shields in the occult and spirituality today - or they should be anyway (in my opinion, of course).

First Part - Cleansing Of The Bodies

We will first begin by ridding any negativities in the three bodies that incorporate us - physical, astral, and mental. To begin, sit down cross-legged, back straight, and breathe deeply yet normally. Inhale through the nose picturing all positive energies coming in and doing its work to cleanse you. Exhale through the mouth and picturing all negativities leaving the body to go on its own somewhere

else. Visualize a circle being made around you, encircling you in a protective bubble. It is in this bubble that your work will make itself present and somewhat of a tingling like electrical feeling that will engulf you for the duration of the exercise.

Speak in a low tone, steady and smooth:

*At the East lies AL (El),
At the West lies IH (YAH),
At the South lies AGLA,
At the North lies ADNI (ADONAI).*

I beseech thee, in the Holy names present, grant me the cleansing I am to receive. Make this body pure as it carries much spiritual baggage - in the Astral and physical, as well as in the mental. Cleanse my bodies so that I may be free from MAKUTH, He who creates discord among lives.

Visualize and feel the positive energy washing over you and forcing all of the negativities to diminish and finally disappear. It is now that you will feel warmth upon your face and back, this is a sign that you have been answered (or, in better terms, successful in the cleansing).

Physical Shield

Cast your circle and sit cross-legged, eyes closed. Have your palms upward as they rest on your knees as if receiving. Breathe in deeply through your nose, and exhale deeply through your mouth until you feel as if you are light headed. Focus deeply on your body, inwardly first and then outwardly. Notice all things present - body rhythm, heart beat, or any other sounds and movements your body makes. Make notice of anything and everything followed by deep concentration to knowing your body well.

Now it is time to focus your concentration and awareness on the outside. Notice sounds, smells, fluxes of energy on the outside and around you. Listen to everything and be aware of your surroundings. This will connect your physical body to your environment as well as your inner self.

Inhale through the nose for a count of eight, hold three, and then exhale through the mouth for a count of eight (repeat 7 times). In a low voice chant the following three times in succession, keeping in mind a rhythmic beat of 7.

Note: This is vital for the shield to be raised, so focus as much as possible.

My body is aware of all energies whether they be within or without. The energy courses in me, through me, and all around me now. It is with my own will that I will that my physical shield comes to life. Protect me from all things physical that will do me bodily harm. My will makes it so, so shall it be.

Keep this thought of protection as an iron command. It will continue to protect you, making you aware of any presence of negativities. With this in thought, you will become very aware of excess negative energy (or baggage) that surrounds you every day. Mentally push these negative energies away and out from you so that they stop right at the protective wall of the shield you created. You might have to perform this shield exercise every time you feel it diminishing or when the feeling that it is gone arises. If you were successful on its creation, this should be very little - perhaps, once or twice a month depending on your energy output.

Astral Shield

Cast your circle and sit cross-legged, palms upward as if receiving, and eyes closed. It is now we shall create the Astral Shield and with patience, a somewhat permanent block on all things astral that can harm us. You will begin by sensing your Astral Body and all dimensions that it contains therein. It is the goal of trying to sense your astral body and dimensions as a complete whole and all at once - the sole object is awareness.

Let us begin by accumulating the energy of Astral light that surrounds our Astral body. Notice that it has its own pulse and feel, like the purest and bluest water you have ever laid eyes on. It is so fluid, peaceful, and calm that you instantly begin to relax your way into its consciousness, immersing yourself in it's tranquil waters.

Holding onto this sense of safety, focus intently, and bring the water all around you so that you can feel its cool touch on your body. Bring it down all the way to where you are sitting and bask in its refreshing fluidity. Let it work itself around you and into you, a tranquil and peaceful feeling that does not allow any negative or outside influence into your watery bubble.

While mentally picturing the blue light all around you speak in an even, low tone:

From the Astral Depths comes my protection and with my will it becomes strong like the winds that blow there. Ala, ye who brings protection from the eye of awareness, grant me protection throughout so that I may see all and know all. It is you, AGLA, who guides me on the Astral realm, may you guide me now as I seek your light.

Chant in succession three times three:

*AGLA, most strong -
AGLA, most pure -
AGLA, protect me.
AGLA, keep me safe.
My will makes it so,
So shall it be.*

As you now accumulate the blue light of Astral Protection, wrap it around your exterior and allow it to permeate your whole Astral being. Allow it to wrap around clockwise, and exert your Astral shield like a whirlwind. Feel the air around you crackle with positive and protective energies from the Astral Vortex. Let the density of this energy remain constant and increase in the deep blue light of awareness.

Hold the light and the energy - allow it to circulate and increase its density so that it will become an impenetrable astral wall. Mentally tell the wall to remain intact even if you are not paying attention to it being there. Program it with intent and strength of will. With this intentional programming it will stay its course until you consciously decide to let it dissipate. Remember, the Astral energies for your shield will be forever charged from the Astral Realm.

Mental Shield

Again we will sit cross-legged, drawing the circle around you, palms upward as if receiving, and focusing on the intent with eyes closed. Inhale through the nose for a count of eight, hold three, and exhale through the mouth for a count of eight (repeat until relaxed).

As before, we will sense the dimensions of our body but this time it will be of the mental aspect. Begin by sensing

the entire astra-physical body, absorbing yourself in your mind and try to see what lies there in the subconscious playground. When you sense the astra-physical body and partially start a soul searching effort you will realize that there is more to you than what you previously thought.

It is here that you might need more protection than you had thought before. Unfortunately we leave ourselves open for many things, leaving our mental chords everywhere, and sometimes we do not even realize that this can harm us, but in fact it can do quite a bit of extensive damage if we are not careful and aware of it all.

This is where the mental shield comes to play, it will be your protection from everything like mental fatigue to mental attacks from entities or worse. Do not confuse mental attacks with psychic attacks for they are very different even though you might think them to be of the same degree. Quite a few people I have known complained of headaches and the like and when I performed a reading of them (psychic, not tarot), I had sensed mental parasites that were leaving them drained. Of course, I had banished them without a second thought, but the fact still remained that they were not protected like they should have been.

When sensing the astra-physical body through the mental aspect, this train of thought effectively spreads your mental body out over your whole awareness. It is now that you will try to sense your whole mental body throughout by focusing inward into the process of your mental thinking. Please pay attention to whatever images you might see behind the darkness of your closed lids because these images might hold some solidity to the why of things.

Begin to accumulate whatever mental energies that appear and fashion them into a perfect sphere inside the circle above your head. Mentally notice the arcs and zapping noises of the sphere in its own power. Feel the light and warmth of the sphere touch the top of your head and let it continue to pulse all the way down to your feet. You might even experience a magnetic pull coursing from your palms upward towards the perfect sphere of mental energy.

Focus your intent and will into the magnetic pulse, draw all lines of energy that course down from the sphere into your palms and hold it there - breathe deeply again as before. Again, circulate the energies clockwise until it becomes an impenetrable wall of energy. Speak in a low and even tone now:

ADNI, be my clarity, allow me to wade through the unnecessary energies that assault me every day. Give me the strength to see myself through the darkness of my mind and guide me to your light of security. Envelope me and protect me as I walk through the valley of life. Grant me the strength as it will be my stepping stone to understanding the divide that my mind is comprised of.

Chant in succession *ADNI* three times three while mentally picturing the perfect sphere dropping down from above your head down to your forehead. Here it will merge with your mind and make it whole and secure, protected by its divine light of well-being. This light will - in turn - act as a permanent barrier to all assaults or incoming negative and ambient energies that seem to latch onto us in every day life. It will wipe away any strain and anxiety that encompasses you wherever you go acting like an impenetrable wall of security and well-being.

It will alert you to all negative energies and who the persons or things are that present them to you. It will always remain active, even when you are no longer focusing on the wall itself, until you consciously bid it to dissipate and shall constantly replenish itself from the energies surrounding you and from the cosmic influences of the universe.

I want you to spend a few moments now, immersed in that wall of protective energy. Feel it working all over your body like a protective suit that keeps you safe. See it working and bending to your will so that you have control of this protection, harness the energy from that perfect sphere so that it will be one with your essence. Send it out through your palms and recite the following:

*ADNI protect me -
ADNI guide me -
See the wall grow and build.
See it permeate my being.
See it become one with me.
My will makes it so,
So shall it be.*

Spend a few more moments visualizing and stabilizing the Mental Shield. Imagine it as an impenetrable wall that nothing shall pass through and if negative energies are present around you, they will be utilized by the shield to create positive energies in their stead.

Psychic Shield

Cast your circle while sitting cross-legged and begin to perform the breathing exercise as before - inhale through the nose a count of eight, hold for three, and then exhale through the mouth for a count of eight (repeat until relaxed and the mind is clear. On a personal note, this requires the use of psionics rather than mystical intentions, which we all possess in our own personal way.

You will begin to visualize a very hard shell of force surrounding your physical body. A sort of outer casing of impenetrable substance that extends about 3ft in diameter and should fill the circle exactly. Picture this shell in perfect clarity so that it truly seems of a physical substance that you could touch if the desire to do so was probable. Extend it outward a little more to test its durability and stability - see if it can stretch or flex with the mind's will. Perform these little experiments to get your mind to familiarize itself with the shell. The mind has to accept the barrier as well or it will not be as strong when the time is needed. It is forever always a sense of willpower and how far you can push yourself in your time of need.

When done you might feel a jolting sense and see a specific color variation in the shield. Pay acute attention to the color because colors represent strength in most meditations. Feedback from the shell might also depend on how sensitive are in the psychic ability department. Common colors that most see (beginners) range from purple to a white and even pink. If you cannot sense the shield or feel its energy - do not worry - it might be because you are not that aware yet.

Remember that the energy will not only come from you, but it will also be in direct link with the universal powers that be. It is also good to say that this energy takes a long time to dissipate. You must be on the watch and find a way to sense if it runs out of fuel so you can redo the process.

Going back to the exercise now - visualize the shell and its impenetrable exterior. Breathe deeply and focus all thought into what you believe as a stable protection. It can be a picture, a certain memory, or whatever makes it possible for you to visualize in your head with perfect clarity. With that in mind, speak the following words:

CASPIEL protect me -
ASYRIEL protect me -
MALGARAS protect me -
USIEL protect me -
RAISEL protect me -
ARMADIEL protect me -
PAMERSIEL protect me -
CAMUEL protect me -

Protect me, oh spirits, ye who are guardians unto the four Towers and beyond. You who interact with the physical plane and grant protection in need. Protect and strengthen me in this hour of need, I ask you.

CAMUEL strengthen me -
PAMERSIEL strengthen me -
ARMADIEL strengthen me -
RAISEL strengthen me -
USIEL strengthen me -
MALGARAS strengthen me -
ASYRIEL strengthen me -
CASPIEL strengthen me -

It is now that I ask you all to guide me with your strength. It is now that I ask you all to weave your energy into my shell so that none may ever pass its barrier. Protect me so that I may not suffer attacks from those who wish to harm me or have ill intent upon their will or have negative energies directed at me. Give me the power in this hour of need. My will makes it so, so shall it be - as above, so it is below.

The wall has been built, the shell constructed, and you are now safe from any intended or non-intended psychic attacks on your person (among other powerful forms of attacks). Be well.

Elemental Shield

Cast your circle while sitting cross-legged and then start your meditative breathing - inhale through the nose for a count of eight, hold three, and then exhale through the mouth for a count of eight. Close your eyes when ready, and look beyond the darkness behind your eyelids. Go past all memory, thoughts, and any visions that might make themselves apparent when your lids are closed. If you are one of those people that see sparks or electrical flashes

when you close your eyes, just imagine that you are just chasing them away with your will.

You are going to learn how to use the various Elements of nature as your source for power in creating the protective shield that will eventually surround you. After you have relaxed to the point of total awareness of everything around you, start to mentally focus the air around you to intensify - like an electrical current. To do this (the breathing helps too because it clears the mind), you must create a magnetic pull where the third eye is located on your brow. Turn your palms upward (as if receiving) and gently focus that magnetic pull into both palms. Feel them charge as they gather the energy - and create what would be called cushions of air that rest lightly (yet powerful) on your palms.

Visualize now the element in which you are choosing to call upon to strengthen your shield. This will be done in the manner of speaking to the spirit of the element in question. If you wish to have materials that would represent the element you have chose, then do it now - remember, this might strengthen your shield considerably more than normal and would be a very beneficial thing to do. Visualize a representation of the said element that would make the vision stronger when you see it in the mind's eye. When you have a clear picture, say the following words:

*Earth bring stability,
Air bring life,
Water bring change,
Fire bring purity -
Spirit bring harmony,
Shadow bring balance.*

Call the element once again to surround and protect you in this hour. Reach outward and call upon Shadow and Spirit to bind the element(s) you have called to strengthen your intended shield of protection. Envision that this binding has now entered you into a large sphere of elemental energy that has been offered to you by the Rulers or representatives of each element themselves.

Speak the chant again this time with more focus on your intended element(s), strengthening your sphere of elemental influence and then joining that energy into your shield of protection. Sounds complicated or long winded, but it is

well worth it - trust me on that one. The elemental shield added to another shield will protect you or someone else from almost anything when cast. This is the same shield that I performed for a friend of mine and his wife because they were plagued with entities. Since then, they have been much better and are finally have the chance to get on with their lives.

Most all of all this shield should be used when others have impure intentions toward you or tries to come into contact with you. The elemental shield can deflect most entities and has a very powerful resistance to negative energies and other nasty things. Sometimes it is just better to call upon all elementals, including the aid of Spirit and Shadow to bind them all and strengthen the abilities a few times fold.

Once the shield is cast efficiently (you should be able to mentally sense it around you if needed), there will be little to worry about after, trust me. With all of the elements tightly woven together to power the shield, not even the demons of the lowest hell will be able to get through without seriously damaging themselves in the process. It will also be noted that with this much power surrounding you it will act as a welcome to higher beings and drastically improve your chances toward them coming and communicating with you as well. Also, this higher energy that your shield generates is one of warmth, safety and peace - spreading that in waves outwardly while keeping you safe inwardly (most people will be effected by the shield in a positive way).

Spiritual Shield

In essence the Spiritual Shield that I will be discussing in this section originates from my grandfather's Shamanic teachings to me when I was little. This Shield has sentimental value to me because it was taught to me by someone whom I had come to respect at an early age. Now I give it to the world so that they may protect themselves better and I have completed one side mission as well. My Grandfather told me to pass it on to as many as I could and I have answered his wish to do so in this book.

Sit cross-legged, breathing deeply with palms in front of the forehead and with eyes closed. Breathe outward through the mouth so that the breath escapes and rises towards the palms. The energy that is accumulating in between the palms

and the forehead will catch the essence of your breath, turning the breath into the purest energy. This is the process of starting the shield because our breath is the purest form of energy leaving our bodies. The breath is also known to hold the Spirit that resides in us and leaves at the time of death. **Note: Many warriors in my Father's tribe who went to hunt drew out the last breath of their quarry the moment they died and obtained their Spirit as a result.*

Lower your hands now to your chest with palms towards you and, in a sweeping motion, waft them to you as if drawing in the air. Stand up and with your left hand (subconscious power hand)- palm down and open - sweep slowly in a clockwise circle around you, blowing your breath toward your hand in a calm motion (not hard). As you are creating your circle say the following words:

*My breath creates a barrier,
A circle of trust and hope,
The Spirits come to aid me,
On the breath they walk slowly.*

Sit cross-legged again and hold your arms out to each side of the circle, palms down, and eyes closed. Visualize the Spirits pouring white light upon you and around you in the circle, encasing your body from head to foot. Visualize and hear them as they chant the song of protection from the Spirit world. Bring your hands to your forehead four times and each time breathe one heavy breath. Feel the breath and visualize it turning into pure protective energy. Feel and sense that your breath is filling up the whole circle with beautiful white light. Feel its warmth and safe nature.

Get up once again, look skyward and say the following words of thanks to the Spirits:

*Spirits that have come to aid me,
You who were here to protect those before,
I give thanks and show my appreciation,
By offering you my breath and energy,
So that you may continue on your journey,
Here, and beyond, as was before,
Peace and love be your light,
Let the wheel continue on as always,
May you guide another as you have me,
May you have peace as the winds carry you home.*

Chapter 3: Preparing the Sigils/Containers

Sigils are indeed powerful no matter if you have belief in them or not. They work as their intention is laid, each one having its dedicated task and continuing on until it is no longer needed. We pour our desires and will into their creation and they live and breathe like any living thing.

Of course, the use of sigils in magick has been a long and well documented history. Many sigils dating back to hundreds of thousands of years. Cave drawings even shed light on some of the more ancient sigils giving the tribes powers beyond normal comprehension. Sadly, some sigils can never be translated because either most do not care to translate them properly or do not have the necessary knowledge to do so. My belief is that most of the more powerful and ancient sigils have been lost in the sands of time due to negligence and selfish reasons - drowned out and forgotten perhaps, or maybe coveted by the many secret orders of the modern world? I guess we shall never know the truth of it.

The sigils I have contained in this section will describe how to properly construct them and then use them accordingly to help you along the way in the rituals that lie ahead. One thing - do not take these sigils for granted. You may think that they are just drawings on paper, but in truth they are very powerful and if unchecked, can do things that you might not have intended.

I have already listed the diagrams and what they can do starting on page 20, so I will not do so again. If need be, you can look back and skim the section again if you feel lost at this moment. This section here will delve you deeper into the meaning of my sigils and let you witness for yourself how powerful they can be - also, may you take heed of my warning and be smart about them as I have instructed. I leave the information now in your capable hands to do as you will. Hopefully, you shalt harm none because I would hate to shake my head sadly in disappointment as your folly unfolds the many twists and turns that shall reap their vengeance.

Physical Sigil/Container

We will begin this section on making the sigils first. It is very important that you know how to make a sigil before you can charge it with the necessary energy that is needed for the task at hand. Always have your materials at hand and most definitely be in a state of mind where positive attitude reigns over everything else. Carry no doubts or ill will to your workplace because this will indeed undermine you in the long run - after all, don't you think that you would rather have success in the operation than defeat?

The first Sigil we will construct is called the Physical Sigil and represents your own Physical Energy or what is also known in some religions as Prana. Prana is pretty much our own essence or what I like to call the life force. Even when we use our own life force for magickal uses, or other intentions, just remember that our life force has what I like to call a forever charger. This forever charge means that no matter how much life force we use up, it always gets recharged by the cosmic energies of the universe. There is of course using too much but I feel that will not be the case anytime soon.

The first thing we shall do in this exercise is to gather the tools we will need to perform what is needed. This of course will be the paper (usually a more dense piece of paper like construction paper or other) which shall be white. Next you will need a piece of charcoal that is preferably black or gray in color. You will need 4 zodiac candles, this of course means your zodiac color and there must be your sign engraved on the candle as well (you can use a needle to inscribe it if need be).

Next you will need a black cloth that has to be large enough to cover the piece of paper (example: if the piece of paper is 10.5 x 8 inches - you will need a piece of cloth that is 22 x 18 inches so that it can cover both sides. What I mean to say is, folding the cloth in half will cover both sides of the sigil with no trouble.

Take chalk and draw a circle that is three feet in diameter - use a tape measure if uncertain. Write three things inside the circle: ANI at the North, AMDI at the South, and IGRAM in the middle where you will put the sigil on top of the middle name. Like so -

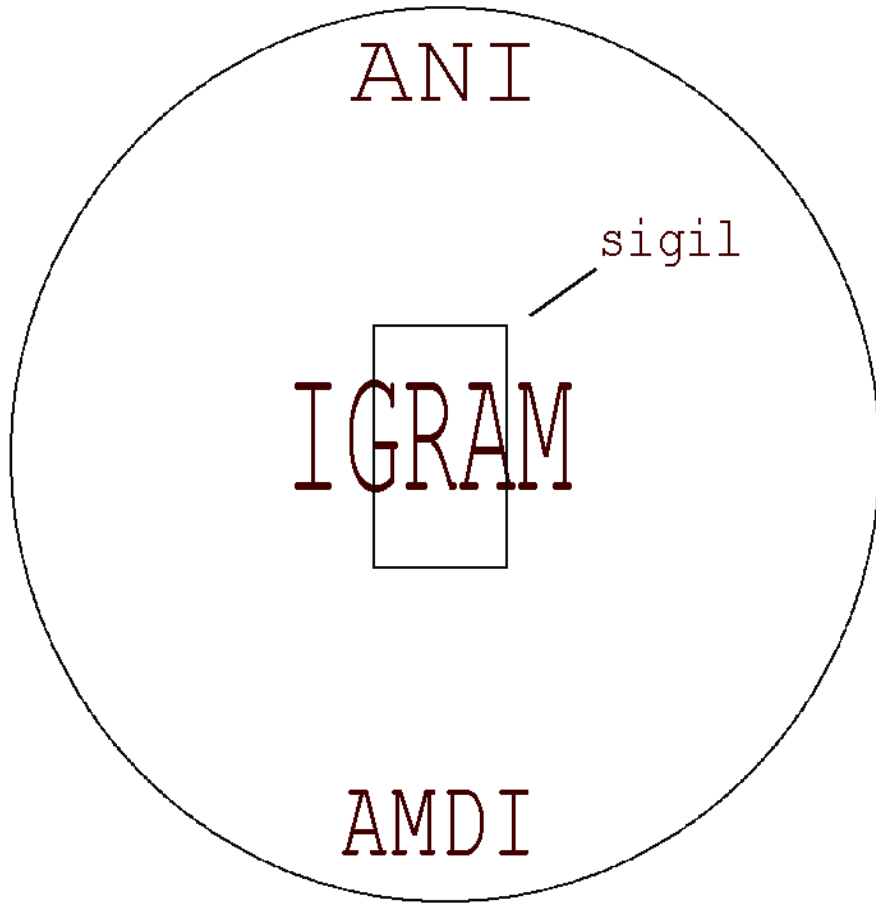

Take the four zodiac candles and rub Spirit Oil on them from base to wick towards you. Intensify positive energy as you do this to increase the power of the candles in your favor and for the task at hand. Have no doubts or negative thoughts or feelings during this time for it will undermine your influence.

Next, take and place the four zodiac candles in the four directions - North, South, East, and west respectively. Hold your palm over each candle and say each name and phrase accordingly for each direction - North: *ANI, give me strength* - South: *AMDI, give me guidance* - East: *IAMRA, give me protection* - West: *Iolo, give me guidance*.

Kneel before the circle where AMDI is written. Place both palms at either side of the written word and say the following:

*My life force before me,
My life force around me,
I direct it into this circle,
Into the sigil I have created,
As ANI as my witness,
As AMDI as my essence,
As IGRAM as my vessel,
My will makes it so,
So shall it be.*

*Flow now as I direct thee,
Charge this sigil with intent,
Course through me, Oh, ANI,
Take from me the life force,
My will makes it so,
So shall it be.*

Draw the hands upward so that the palms face each other in front of the chest. Deeply inhale through the nose, and exhale through the mouth four times in succession. Feel the magnetic pull in the palms - build that energy up so that you can feel a perfect sphere of your Physical Energy.

Focus all of that energy into the sigil and sense that it is being absorbed directly from the sigil. Carefully lay out the black cloth in the circle on the left side of the written word IGRAM. Place the sigil in the black cloth and cover it up so that none of the paper is visible to the eye and then leave it in the circle overnight. Do not take the

covered sigil out of the black cloth and do not take the covered sigil out of the circle until the morning after. Place the sigil in a dark place - and also a place where it shall not be disturbed by anyone other than yourself (if anyone else touches it, you will have to do the ritual over.

Astral Sigil/Container

The second sigil we will discuss is called the Astral Sigil which, in essence, is coined from the term Astral Energy. Astral energy is an important factor in the works of magick, not only for the degree of energy that the Astral Realm generates, but in which the direction it can be channeled for. Astral energy, believe it or not, holds more essence than Spiritual and Physical three times fold. This degree of scale makes Astral energy, in my personal opinion, can save a person from fatigue and energy loss resulting from how much energy was used for the circumstance at hand.

The sigil itself can be used over and over like rechargeable batteries - just remember to recharge ever so often when you can see a distinct dimming of the glow like described when you sense the energy being out into the sigil as described in the Physical section prior to this one. The first thing we shall do in this exercise is to gather the tools we will need to perform what is needed. This of course will be the paper (usually a more dense piece of paper like construction paper or other) which shall be black. Next you will need a piece of white chalk that is preferably white or light gray in color. You will need 4 zodiac candles, this of course means your zodiac color and there must be your sign engraved on the candle as well (you can use a needle to inscribe it if need be).

Next you will need a black cloth that has an open eye drawn on it and it has to be large enough to cover the piece of paper (example: if the piece of paper is 10.5 x 8 inches - you will need a piece of cloth that is 22 x 18 inches so that it can cover both sides. What I mean to say is, folding the cloth in half will cover both sides of the sigil with no trouble.

Take chalk and draw a circle that is three feet in diameter - use a tape measure if uncertain. Write three things inside the circle: ANI at the North, AMDI at the South, and IGRAM in the middle where you will put the sigil on left of the middle name. Like so -

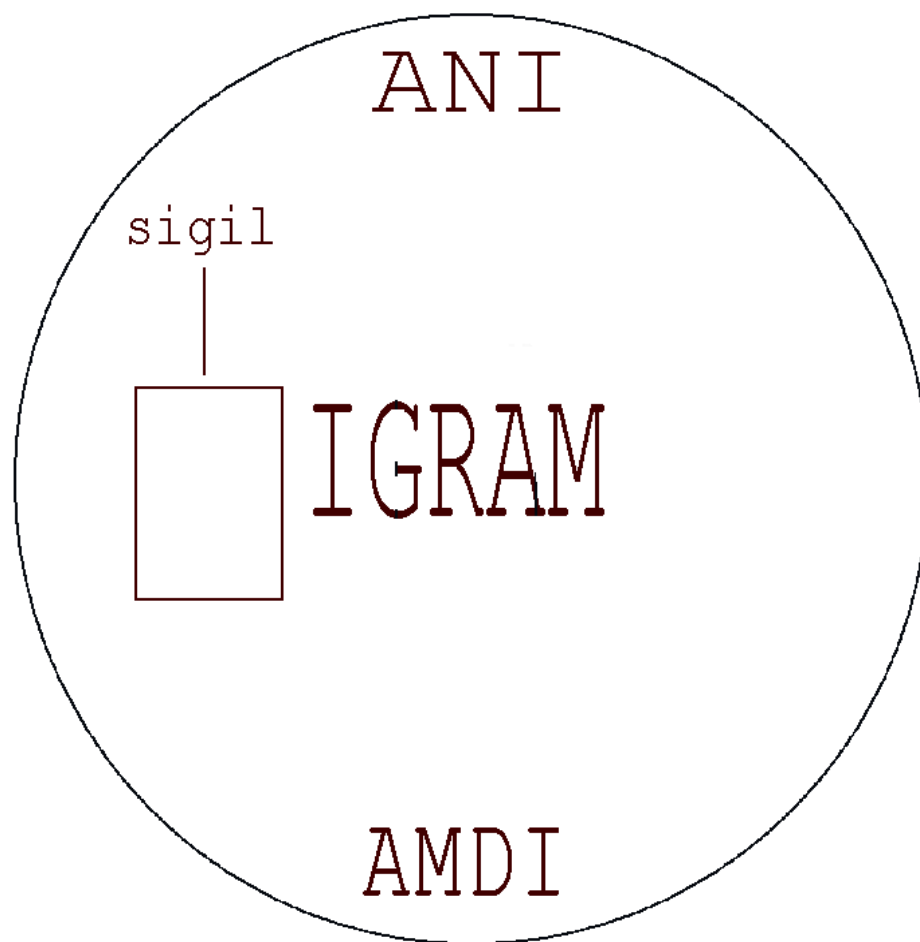

Take the four zodiac candles and rub Astral/Spirit Oil on them from base to wick towards you. Intensify positive energy as you do this to increase the power of the candles in your favor and for the task at hand. Have no doubts or negative thoughts or feelings during this time for it will undermine your influence.

Next, take and place the four zodiac candles in the four directions - North, South, East, and west respectively. Hold your palm over each candle and say each name and phrase accordingly for each direction - North: ANI, give me strength - South: AMDI, give me guidance - East: IAMRA, give me protection - West: Iolo, give me guidance.

Kneel before the circle where AMDI is written. Place both palms at either side of the written word and say the following:

*Astral Energy before me,
Astral Energy around me,
I direct it into this circle,
Into the sigil I have created,
As ANI as my witness,
As AMDI as my essence,
As IGRAM as my vessel,
My will makes it so,
So shall it be.*

*Flow now as I direct thee,
Charge this sigil with intent,
Course through me, Oh, ANI,
Bring to me the Astral energy,
My will makes it so,
So shall it be.*

Draw the hands upward so that the palms face each other in front of the chest. Deeply inhale through the nose, and exhale through the mouth four times in succession. Feel the magnetic pull in the palms - build that energy up so that you can feel a perfect sphere of your Astral Energy.

Focus all of that energy into the sigil and sense that it is being absorbed directly from the sigil. Carefully lay out the black cloth in the circle on the left side of the written word IGRAM. Place the sigil in the black cloth and cover it up so that none of the paper is visible to the eye and then leave it in the circle overnight. Do not take the

covered sigil out of the circle until the morning after. Place the sigil in a dark place where it shall not be disturbed by anyone other than yourself. If anyone else does touch it, you will have to do the ritual over because others can diminish the Astral Energy you have stored.

Spiritual Sigil/Container

Last but not least, we have the Spiritual Sigil. This is considered a very unique and separate sigil because it represents all that is unknown. Spiritual energy is considered to be more sacred than any other type of energy and throughout history Spiritual Energy contains the building blocks of life.

Spiritual Energy has the necessary means to influence everything around us with the right technique and application of that technique. Even though this section deals with the making of the sigil, it still needs the right direction or push to become a container.

You will find by more and more experience with energies that Spiritual Energies will be used more than any other energy, even Astral Energy. When we use Spiritual Energy we are connecting with the universe and this process creates a harmonic balance with all living things. Do not look at it like we are just taking the energy because, in fact, we are also helping remove stagnant energies in the universe as well. This stagnant removal helps process a change, kind of like replacing swamp water with fresh water.

I want to begin by gathering the necessary tools needed to complete this. You will use white paper this time, but instead of using black chalk we will use blue. Blue represents life itself (some say gold, but gold is limited). Blue is the color of life and it has properties that are full of fluid motion like a stream or river constantly flowing toward its goal.

Next you will gather two silver altar candles, two white altar candles, four zodiac candles, and two black altar candles. Take Spirit Oil and rub it on the two silver and two white altar candles from wick to base towards you saying: *Spirit and Essence reside*. Now taking the blue chalk, draw your circle as show below. Even though you will see a difference in this circle from the other two, this is because Spiritual Energy is much more powerful than most (save Astral Energy).

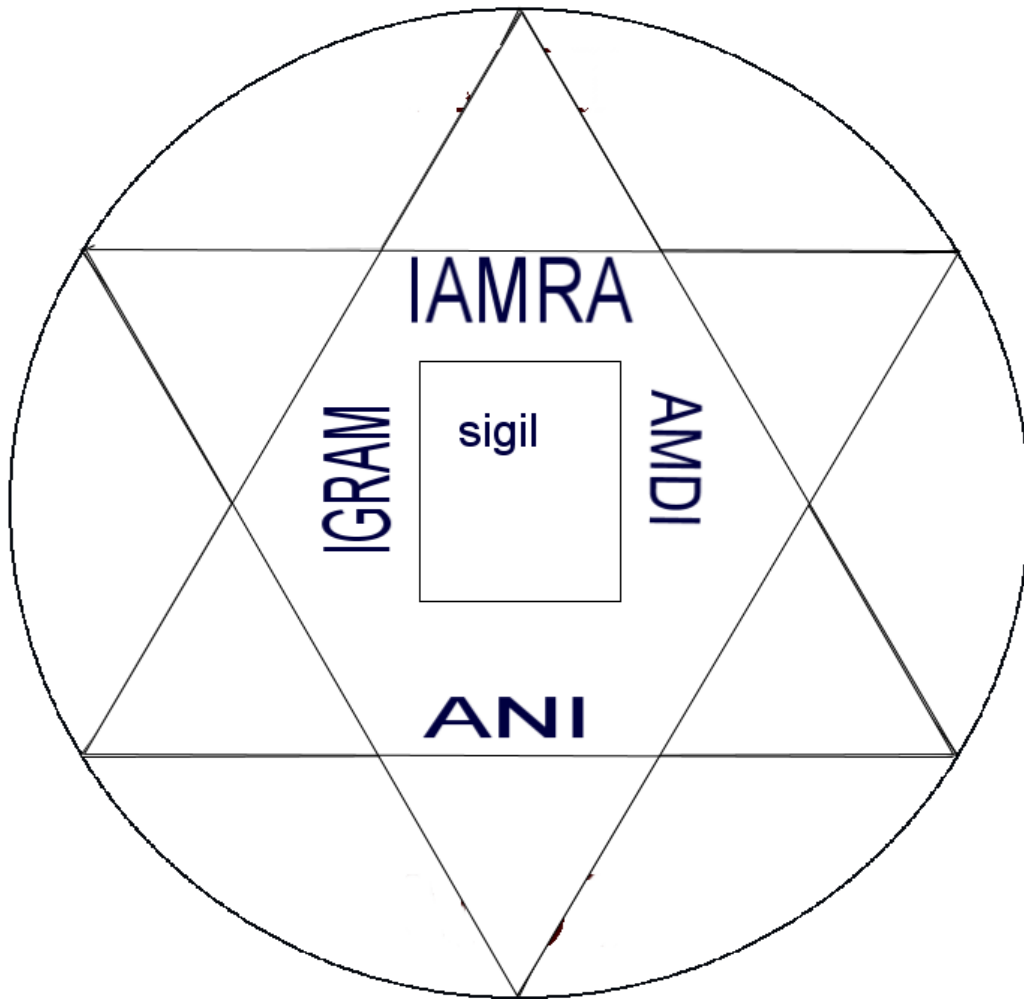

Place the two white altar candles on the inner top points of the star. Place the two silver altar candles on the bottom inner points of the star. Place the two black altar candles at each top and bottom point (one for north and one for south). Take and rub zodiac oil of your sign on the zodiac candles rubbing from base to wick towards you and say the following: *Anui Alut ehieh*. Place them now on the line of the circle on the top half and the bottom half all on each side of the north and south points.

Light the white candles first starting with the left and then to the right saying: *Nahm Shep Abur*

Light the silver candles from right to left saying: *AMRI Ewehe AMDI Eheieh*

Light the black candles from north to south and say: *IGRAM ILANIL ORIELE*

Kneel at the south point of the star, palms out towards the circle and say the following:

*Spiritual Energy before me,
Spiritual Energy around me,
Spiritual Energy flowing through me,
I direct it into this circle,
Into the sigil I have created,
As ANI as my witness,
As AMDI as my essence,
As IGRAM as my vessel,
My will makes it so,
So shall it be.*

*Flow now as I direct thee,
Charge this sigil with intent,
Course through me, Oh, ANI, IAMRA, AMDI -
Bring to me the Spiritual Energy,
My will makes it so,
So shall it be.*

Draw the hands upward so that the palms face each other in front of the face. Deeply inhale through the nose, and exhale through the mouth four times in succession. Feel the magnetic pull in the palms - build that energy up so that you can feel a perfect sphere of your Spiritual Energy.

Focus all of that energy into the sigil and sense that it is being absorbed directly from the sigil. Carefully lay out the black cloth in the circle in between the written words that line the center of the star. Place the sigil in the black cloth and cover it up so that none of the paper is visible to the eye and then leave it in the circle overnight.

Do not take the covered sigil out of the circle until the morning after. Place the sigil in a dark place where it shall not be disturbed by anyone other than yourself. If anyone else does touch it, you will have to do the ritual over because others can diminish the Spiritual Energy you have stored in the sigil. It is done.

Chapter 4: Energy Building Techniques

This section will deal with Energy building techniques for the above Energies. Energy, no matter what type it is, has its own conscious intelligence. You may ask the same question over and over - If it is an intelligent source of energy, why can we manipulate it then? The answer ... it has an active role in the universe to be shaped, molded, and guided by thought. We, as a race, have much more power than we realize. We were created for such a purpose but lack the awareness to comprehend the full nature of what we can do. It is exactly like we are small children and need instruction to adapt and move on in the world guided by our knowing parents in our time of need.

Listen, for I will tell you a secret - when we were growing up our parents and society programmed us without even knowing it. We were subject to a view that was governed by others, not the proper one, but one that was predetermined before we were even born. Just as we teach our children things that we think is right and wrong, so did our parents and their parents. Every generation is different though, we just assume that it is the right thing to say to our children.

This, in fact, is wrong of us. When we stick a stuffed animal in front of a baby's view we are not teaching them what needs to be taught. We are blocking them from the universe and what mysteries lie there. We are telling them that the invisible world that shares our world is no longer there and they grow up believing that nonsense. We deprive them of the innocence they need to become aware spiritually.

All these things are on the domino effect or ripple effect. One course of action sticks into another course of action until there is nothing genuine and pure about any of the actions presented. That is why most people have a hard time visualizing what they need to in magick, they have a very difficult time in building up energy necessary for magick to work because of all the blocks that were superimposed from birth up to their adulthood.

Yes, many people try very hard to remove these blocks but it goes on deaf ears and dry impulse. By the time they realize that they can change these things and open themselves up it is far too late. The course that was laid out for them by the older generations has set far too deep in their subconscious.

That is where this section will be of use to anyone, even if you decide not to make use of the rituals within these covers. It is my intent to show you what the universe has to offer besides the illusions of reality predetermined before we were even born. One idea to consider - nothing is as it seems. If you remember anything in this world, remember that and commit it to memory. You will see that once you believe this to be fact that many doors will open to you and your subconscious. One thing that I like not to say is that one can even alter the fabrics of reality in the right state of mind.

Physical Energy

We will begin this section by building up your Physical Energy. This meditation is excellent for beginners as it helps to give one a feel for energy. This meditation also strengthens the aura when done regularly and slows down the aging process as well.

1. Begin by relaxing your entire body. The deeper the trance, the more effective, but this meditation can be done at any time and a trance is not necessary.
2. Breathe in and at the same time, draw in energy from all sides of your body, front, back, top of your head and bottom of your feet. For beginners, you should visualize white brilliant light, like the sun. Working with colors is more advanced and most effective when you are a bit more experienced.
3. Exhale and visualize the energy expanding your aura.
4. Breathe in again and visualize the energy getting brighter and more powerful, radiating from your entire being.
5. Exhale again and visualize the energy expanding your aura, and the center of your body shining brilliantly like the sun.
6. Repeat this several times, each time visualizing the energy becoming brighter and brighter as it increases in intensity.

When working with colors, visualize the color becoming more and more powerful and vibrant. You will notice each color has a different feel to it. Colors can be used to attract according to their nature.

You can also breathe in energy from the front and back sides of your body at the same time to meet in the middle, then do the sides and top and bottom. After this, let your aura expand outwards.

With this meditation, you can also practice expanding and contracting your aura. One thing to keep in mind that when you extend your aura outwards, you also expand your energy to a degree so that it engulfs others and can be used for healing like 'Laying of Hands'.

Many people who are healers and have opened their third eye do this as a means to utilize their energy for good and should be considered as a means to heighten the karmic balance within you.

Astral Energy

The next technique is building up Astral Energy. Astral Energy is just as important as Physical and Spiritual because it taps into an infinite source that can be utilized for anything. When in the Astral we can perform many feats that our physical body cannot handle - this being that our physical body has a lower stress limit than what the Astral Body does.

One can even heal any dire disease and/or sickness in a physical body when they are in the Astral body by reaching in the said physical body and plucking it out or transforming the negative energy of the said disease or sickness into positive energy. This process is called the Auric Essence Transformation Process or AETP.

Not many people know how to perform this as well as others and most have not even heard about it because some Masters keep this information from reaching the public range of attention. They wouldn't be Masters if anyone could do it, right?

This meditation is the most powerful and will require attention to detail. The exercise has been done by many skilled people and advanced Masters from many different occult and new age studies. It enables the practitioner to feel, control and direct energy through the Astral Body to the physical body and then to the said target of choice. So, be patient, because you more than likely will need fifteen minutes to half an hour set aside for this to begin with.

Again, everything is individual. In the beginning, for most people, the energy will be slow in coming and will move like molasses, but this varies according to one's development in Astral attention. Normally with repeated meditations, it will speed up and you will be able to direct it at will. This exercise is more in (sensing), and will be regarded as such every time it is done. You must place your astral hand over the area intended every step.

First things first, you must separate from your body and open the third eye. After separation occurs, sit across from your physical body as in the creation of the Astral Sigil exercise. Let us begin ..

1. Focus on your crown chakra. Just sit 3-4 minutes and meditate on this chakra. You may feel it as a sort of crawling sensation. This is normal. When one advances or on occasion, there is an intense feeling of bliss. You may also feel a pressure there.
2. Now focus on your third eye. Meditate on your third eye for several minutes. Feeling a pressure here is normal.
3. Move your attention to your throat chakra and do the same as with the above two chakras.
4. Move your energy to your heart chakra and focus for a few minutes.
5. Focus now on your solar plexus and do the same.
6. Follow with your second/sacral chakra- do the same.
7. Now focus on the area between your perineum. This is between the rectum and scrotum for men and between the rectum and vagina for women. This is a power spot. Visualize the energy glowing brightly like the sun here.
8. Move the energy to your base chakra and meditate for 3-4 minutes or so on your base chakra.
9. Now, direct the energy up your spine into your second chakra. (This is the second chakra located on your spine- with the first circulation, we focused on the chakras in the front, we are now directing the energy up the back).
10. Continue to do the same, directing the energy up into each chakra, one by one located in the spine, until you reach your crown.

11. This time, you can direct the energy without pausing, moving it along down the front of your body chakra by chakra until you stop again at the perineum and direct the energy up your spine.

12. Keep circulating the energy as long as you wish. This exercise will enable you to control and direct the Astral Energy. This is the foundation of all power. You will establish a mind connection to where you are able to focus and the Astral Energy will follow even if you are in physical form. Even though we are directing this meditation towards building up Astral energy, this can be used for healing, empowering or otherwise if intended.

Spiritual Energy

Sit comfortably, preferably cross legged, but sitting in a chair is fine as long as your spine is straight. Go into a trance state. You should take a couple of minutes to clean your aura before beginning this exercise. The meditation is performed in 18 breaths.

Visualize yourself inside of two pyramids. The standard meditation is done with white-gold energy inside of the pyramids, but you can change colors as you become more experienced and know how to handle color energy. White-gold energy is the most powerful energy and is known as Spiritual Energy.

1. With your thumbs touching your index fingers, inhale to the count of 6, hold for 6, exhale for 6, and then chant either aloud or silently in your head: *S-S-S-S-A-A-A-H-H-H-H*, in one long exhale while visualizing both your pyramids filling with a brilliant white-gold light.

2. With your thumbs touching your middle fingers, inhale to the count of 6, hold for 6, exhale for 6, and then chant either aloud or in your head: *T-T-T-T-A-A-A-H-H-H-H*, in one long exhale. Continue to fill the pyramids with bright intense and powerful energy.

3. With your thumbs touching your ring fingers, inhale to the count of 6, hold for 6, exhale for 6, and then chant either aloud or in your head: *N-N-N-N-A-A-A-H-H-H-H*, in one long exhale. Continue to fill the pyramids with bright intense and powerful energy.

4. With your thumbs touching your little fingers, inhale to the count of 6, hold for 6, exhale for 6, and then hiss (one long "S" sound for the exhale): S-S-S-S-S-S-S-S-S-S, in one long exhale. Continue to fill the pyramids with bright intense and powerful energy.

5. Again, with your thumbs touching your index fingers, inhale to the count of 6; Hold for 6, Exhale for 6, while visualizing both your pyramids filling with a brilliant white-gold light. There is no need to chant for this step.

6. With your thumbs touching your middle fingers, inhale to the count of 6, hold for 6, and then exhale for 6, while visualizing both your pyramids filling with a brilliant white-gold light. There is no need to chant for this step.

From now on, with each and every breath throughout the meditation, you will draw in and visualize Spiritual Energy entering through both ends of the breathing tube at the same time.

The breathing tube extends for one hand length (measured by the length of your own hand) beyond the top of your head, down through your seven chakras and ends one hand length past your base chakra located at the end of your tail bone. When you are standing, it extends one hand length beyond your feet.

Your tube is as large around as the circle made when you touch your thumb to your middle finger and tapers to a small opening at each end. The tube is transparent like glass (You should always visualize yourself inside of the pyramid throughout the entire exercise).

7. With your thumbs touching your ring and little fingers, index and middle extended as in the illustration to the left, inhale and breathe in energy to the count of 6, visualizing brilliant white-gold light entering the tube from both ends at the same time to meet between your 2nd and 3rd chakras. Hold for 6. The light forms a sphere the size of a grapefruit. Exhale for 6 and visualize the sphere brightening with energy.

8. Keep your thumbs touching your ring and little fingers, index and middle extended as in the illustration to the left, inhale and breathe in energy to the count of 6, visualize the sphere growing in size until it reaches the base of your rib cage and the top of your pubic bone. Hold for 6. Exhale for 6 and visualize the sphere brightening with intensity.

9. Continue to keep your thumbs touching your ring and little fingers, with your index and middle extended as in the illustration to the left. Inhale and breathe in energy to the count of 6, Visualize the sphere brightening and growing in concentrated power. Hold for 6, visualizing and feeling the brightness, intensity and power of the sphere. Exhale for 6, visualizing the sphere grow brighter and brighter, and more and more powerful.

10. Keep your hands in the position shown in the illustration to the left, inhale and breathe in energy to the count of 6, the sphere is reaching maximum concentration, it ignites, changing color to a white/electric blue flame and turns into a brilliant shining gold like that of the Sun. Round your lips to blow. Blow on the exhale for a count of six. As you blow, visualize the sphere expanding to surround your entire body. The smaller sphere still remains, and is more concentrated and brighter than the larger one (Visualize yourself like you are blowing up the sphere).

11. Keep your hands in the position shown in the illustration to the left, inhale and breathe in energy to the count of 6, Visualize and feel the energy entering your breathing tube at both ends and concentrating in the smaller sphere and expanding out into the larger sphere. Hold for 6. Exhale for 6 and visualize the concentrated energy continuing to expand into the larger sphere making it brighter and more powerful.

At this step, you will more than likely see the smaller sphere beginning to spin. It can spin either way. Visualize the spinning and go with the flow.

Steps 12 and 13 are the same as 11. Keep spinning the Sphere. As you progress, you will notice that you are beginning to feel very light headed and possibly feel like floating (everyone is different on the reaction).

14. For men, place your left palm on top of your right palm, both facing up. For women, place your right palm on top of your left, both facing up. At the beginning of your inhale, move the smaller sphere up to your 4th chakra, inhale for a count of six. Hold six, and then exhale for another count of six.

(This is standard as the heart chakra is the most powerful of the chakras. With experience, you can move the ball to any chakra of your choice. This includes the 8th chakra as well).

15. Inhale for a count of six and say to yourself in your mind "EQUAL SPEED" The 2 pyramids will begin spinning in opposite directions. The top pyramid will spin counter clockwise and the bottom pyramid will spin clockwise. Round your lips and blow as you did before, for a count of six, spinning and feeling the spin of your pyramids in opposite directions. They will be moving at 1/4 the speed of light. The spin feels like a pulsating sensation.

16. Inhale for a count of six and say to yourself in your mind (half speed of light). Round your lips again and blow for a count of six, spinning and feeling the spin of your pyramids in opposite directions. They will be moving at 1/2 the speed of light.

17. Inhale for a count of six and say to yourself in your mind (three fourths the speed of light). Round your lips again and blow. As they approach 3/4ths the speed of light, a flat disk located beneath your naval pops out and expands to a distance of approximately 55 feet in diameter. Continue to blow out with force and feel the speed of the disk increase and stabilize.

18. Inhale for a count of six and say to yourself in your mind (speed of light). Visualize your disk and the pyramids spinning so fast (the speed of light is 186,000 miles per second) they give off intense white light and energy, hold for six and blow for six. This will stabilize the disk enough to generate the energy into you becoming one with your essence.

Note: It is strongly advisable to remain meditating upon the energy for 5-15 minutes afterwards, concentrating on feeling the pulsating sensation of the disk. This will ultimately insure that the energy stays with you afterwards and does not seep away.



Part 2: Advanced



Chapter 5: Applying the Energy

In the last section we discussed building up the various forms of energy needed to charge the sigils. Now we are going to discuss on the application of the energies itself. This will eventually be used for other sources of energy and different applications as well. After you learn to use and apply the various forms of energy - well, the sky is the limit.

Using the Sigils/Containers

After charging the sigils, they become containers. Like little vessels that hold all of the energy you have placed into them. Like vessels, they never wane and never diminish as long as you use them in an appropriate time and manner. Every month or so I would keep putting energy into them, this will insure that they recharge and keep from getting stagnant. Remember, even energy can get stagnant once and a while and needs new blood, so to speak, to keep the energy in a constant flow.

I would say the third day before the full moon would be the most practical, but any day in the waning phases is pretty sufficient in the cause. I would burn incense around them twice a week, mostly on Tuesdays and Saturdays. These days of the week hold significance for power for the said operation. Start to charge the sigils between or around 10-11pm (give or take). Most times tables require that the rituals be performed in the hours of AGLA, Caera, Salam, or Yayn.

This of course reflects upon the angels of that hour as well which consist of Anael, Raphael, Gabriel, Zamael, and Michael. They have a direct influence and will aid you in your hour for charging if you call upon them (which can be helpful because they increase the energy twice as much).

Each sigil that was listed in the prior section has a proper place for each ritual listed after in the rituals section and should be used accordingly. Do not try to mix and match or experiment until you are fully aware of the consequences of dabbling in what you do not know. I am only trying to protect you until it is time to be your own master.

Storing the Sigil/Containers

As was spoken before, the sigils will be stored in their said cloth. Each sigil is different, but none shall ever see sunlight and that is a cardinal rule. Sunlight can diminish the power of the sigil and render it useless. Also, any other person who touches any of the sigils can taint the power that you have placed in the said sigil. Remember to keep them safe and above all else keep them protected from any negative energies by placing a protection on them. Also remember to keep them in a place that they shall never be disturbed by outside influences (other people, etc.) like your closet or any other room that you will can guarantee that they will not be disturbed.

Every Monday, Friday, and Saturday of each month you can let them absorb moonlight if the moon is in the opening phases. Never allow them to soak in the rays of a new moon, the effects are not desired because they will inherit an intelligence that will not be suited for the upcoming Rituals listed in this book. It is advised to pay particular attention to these details for in the end they will save you quite a bit of trouble and difficulties.

Like was stated before, you can burn incense around them like Dittany of Crete, Sandalwood (red), or Bergamot (Orange). These types of incenses shall insure their power, their intelligence, and above all else, their desire to radiate internally.

CHAPTER 6



WERE-CREATURE RITUALS

Chapter 6: Were-Creature Rituals

I am going to discuss a moment about what the Were-creature Rituals contain. It is a brief overview and will explain what each ritual holds. Bare with me as it might be unnecessary, but I feel that it is warranted enough for those who wish to know a little bit more of information regarding an explanation.

The overview is as follows:

Ritual 1 - Trial of Spirit and Air

The first stage is called the Trial of Spirit and Air - this is where you will summon the Animal Spirit you have chosen in the beginning from the lower realms of the Astral Realm (also called the Astral Jungle or Astral Wilderness) and coined the Bowels.

"The Astral Wilderness is where the essence of an animal goes after they pass on (many claim that animals do not have a soul, but this is not true - the Astral Wilderness is a case in point). It is here that the souls of animals merge back into the Great Consciousness that is defined by our Native American Spirituality and Spiritual Beliefs, also known as the Great Spirit."

*~Daniel 'Flying Eagle' Littlejohn~
(Shaman/Medicine Man of the Ho-Chunk Nation)*

The Astral Wildlife that dwell in these bowels are actual spirits that were once alive but roam there now to uphold a balance of energy. As regarding other beings, such as the Wendigo, Manticore and other said creatures - all that is required for that particular sense would be for the Exorcist to clearly and vividly picture the being in pure desire. Hence, surround yourself with every possible aspect of the being during the programming of the Morphogenetic Sub-Field(s).

It is here in this Ritual you will see for the first time an embodiment of your Animal Spirit in the mirror before you. The Animal Spirit will establish contact through vocal or mental communication. This is possible because you will be anchored with the Animal Spirit - that is the intention.

All courtesies are now proper and you will want to ask it if it will begin a relationship with you. This is of course necessary for the second Ritual to begin and take its proper course.

All formalities are on you after that point. Once you have made a commitment and asked the Spirit for a bond you will continue to see your Animal Spirit whenever you look into a mirror and hear them as if it were a guide (like a Spirit Guide, if you will). From now on you will have direct communication with your animal Spirit and you will do wise to respect your Animal. Otherwise, the bond will be forfeit and you will have to perform the Ritual again.

If by chance that the Animal Spirit does reject you on the first encounter, perform a banishing of your Ritual Area and perform the Ritual again after three days. If you find an Animal Spirit that will bond with you and everything feels right, make good with your Animal Spirit and strengthen the bond/relationship between you. When it is time you will continue on to the next Ritual.

Ritual 2 - Trial of Shadow & Water

The second stage or Ritual is called the Trial of Shadow and Water. This is where you will finally uphold your bond/relationship and merge with your Animal Spirit in essence. You will finally be one and feel greater energy after it has happened so it is wise to be prepared for the after-effects. The apparent side-effects of the after-effects might be a feeling of sickness (nausea), light-headed, euphoria, ecstasy, disorientation, high feeling, a hang-over type feeling, headache, insomnia (mostly because the Animal Spirit is restless), and dizziness.

When I first merged with my Animal Spirit fifteen years ago I experienced nausea, dizzy spells, and headaches but there was a mass feeling of euphoria as well. I slept quite a bit during the day (when time provided it), and was pretty much a night owl for the rest of it. I felt like I was pumped with so much raw energy that it seemed I would explode into a million pieces - such is the energy of the Animal Spirit when it separates from the Wilderness into your being/essence. It was pure bliss and I will never forget that moment when I felt whole - no more was I feeling like I was living a half-life prior to the bonding. You will see for yourself when the time presents itself and you are ready.

Ritual 3 - Trial of Fire and Earth

The third stage or Ritual is called the Trial of Fire and Earth. This is the last stage and Ritual of the process to physical Shifting. This is where you will finally feel the first pre-stages of physical transformation or as local slang coins it as 'p-shifting.' The Dark Matter mass will add onto your own existing form and create the necessary accumulation or build-up for you to change it the very first stages of your phenotype form. It will be very difficult to control at first for about the first year, but in time you will be able to master it properly with dedication and practice.

From my own personal experience, it was rough for the first year and there was some pain, but it was well worth it. It will be much more difficult to control the direct urges of the Animal Spirit which trigger sporadic changes in the most awkward situations that you must watch out for. The binding circles, meditations and other precautions in this book will help you to control them.

The precautions and other necessary information for controlling the Spirit Animal was not presented to me in the beginning though. I had to, through much trial and error, find these out for myself and so I am putting them in this book so no one has to experience the hardships I had to in the beginning. I would not wish that on anyone, friend or foe alike and trust me when I say you are very lucky indeed.

Before you look on the next page at the Rituals I want to thank you for your time and patience. I also want to thank you for never giving up hope of becoming one of the three things listed in this book. It is my personal goal and dream to make a unified existence in this world, and to make the Divine Change presented in our evolutionary process.

It is here and now that we will make a stand when our numbers are greater and we will no longer be ignored by anyone. We will be here to stay, a family, a pack that will never know what being condemned is all about. Know this also - I will not tolerate any basic degrading of another person whether they be another Were-creature, Shape-changer, Vampier, or any other being. We will set the example for all to learn from.

We will get along, otherwise we could spell out the end of our world as we know it. There will be no wars between the types and I will not live out the rest of existence fighting others of my kind (or any other kinds). Mark me well when I say that this is the last message you will ever hear on the subject - any who oppose this will be reprimanded and I do not mean by a simple punishment.

1st Ritual : Trial of Spirit & Air

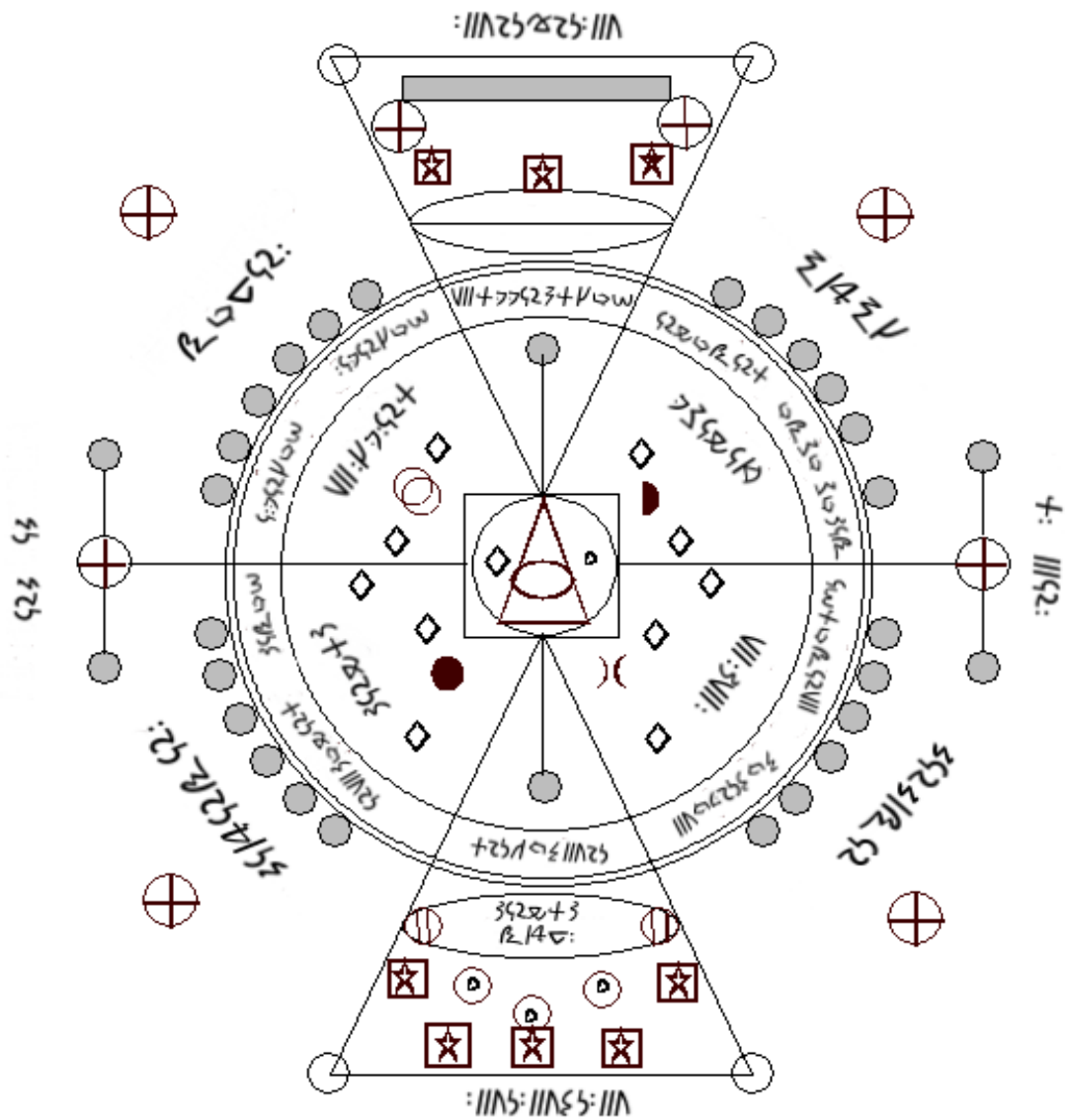

This is the Ritual where you summon the Astral Animal Spirit to you. You will introduce yourself to your animal and create a relationship so that you can merge with it. This is very important if you wish to physically shift from human form to any of the phenotype forms (hybrid or true form). Creating the bonds between your Animal Spirit and yourself are very beneficial. Once you have a mutual understanding of the bestial or animal side it will not try to take over when you are transformed.

This way you will not murder in masses while strutting around in your would-be phenotype hybrid form when the first changes occur in the early stages of becoming your true phenotype form. This ritual is to be performed in the hour of Salam on the first crescent phase of the waxing moon.

Materials Needed:

- 1** - Large mirror (one that you can see your whole body in when sitting down and big enough for your spirit animal to pass through). Also preferred that it shall be of 60 inches of length, and 40 inches wide. It shall have a metal frame as a conductor between worlds. Frame anointed with Astral Oil.
- 2** - 30 black altar candles (to banish and protect from negative energies during the operation. Each altar candle will be a standard 3x4 inches. Rub Protection Oil from base to wick towards you.
- 3** - 4 silver candles (to establish a link with the Astral Realm). Each will be a standard size of 3x4 inches. Rub Astral Oil from base to wick towards you.
- 4** - 2 zodiac candles w/ personal zodiac sign inscribed on it. Each will be standard 3x4 inches. Rub Zodiac Oil of the appropriate sign from base to wick towards you.
- 5** - 4 deep purple candles (for connection with Animal Spirit on a psychic connection level). Each will be 3x4 inches standard. Rub Spirit Oil from base to wick towards you.
- 6** - 10 clear quartz crystals (for influence). Anoint Spirit Oil on each.

7 - 3 moonstones (lunar influences and aid). Anoint Moon Oil on each.

8 - 10 cones of Dittany of Crete (for summoning aid).

9 - 10 stone fire censors for the incense. Rub Connection Oil on the Censors.

10 - Spiritual Sigil

11 - Sigil of Base

12 - Astral Sigil

13 - Physical Sigil

The diagram must be made with white chalk. The main circle will be the diameter of your height (for example, if you are 6ft, then the circle will be 6ft in diameter). The mirror will be set in its proper place as show on the diagram afterwards.

The main triangles will be drawn in after the circle and will be 3ft longer than your physical height.

The inner circle will be half of your height (3ft, if you are 6ft and so forth) as will be the outer triangles.

The fire censors will be evenly spaced as shown on the diagram (represented by stars).

The purple candles are to be set out on the outer points of the larger triangles.

The silver candles are the circles with the crosses on them and will be placed appropriately.

The mirror will be placed in the upper outer triangle facing you. You will be sitting in the middle diamond where the two outer triangles cross.

The crystals are represented by diamonds on the diagram and will be placed accordingly as shown on the diagram.

The moonstones will be placed as shown on the diagram. They are represented by the tear shapes as shown on the diagram.

You can see them placed on each side of the mirror, one in the inner circle, and one in each circle that is connected to the fire censor.

Light all purple candles first - clockwise and each time you light one say '*Eom.*'

Light all silver candles second - clockwise and each time you light one say '*Demh.*'

Light all black candles third - clockwise and each time you light one say '*Sheogh.*'

Light both zodiac candles from left to right - and after you light each one say '*I am open.*'

Light all fire censors - clockwise and after each one is lit say '*may the door be open.*'

Sitting in the diamond where the two triangles meet, you will close your eyes and open your third eye - breathe in for a count of 7, hold 3, and exhale 7 (do this 15 times).

Focus all of your energy and power into the mirror and say: *As was before, it is done so again. The door that was once locked opens in this hour as I command it. May the door open before me between worlds so that I may find my Spirit Animal.*

Open your eyes and look at the mirror in front of you. When it becomes foggy, the door has opened. Now you must call your astral/spirit animal so that you may strengthen your bond and let the astral/spirit animal know that this is your intention.

You must have a clear mind and have no negative energies surrounding you. One way to do this is to perform the 'clearing the mind' exercise you had completed to open your third eye.

Mentally picture the astral/spirit animal at this point in your head so that is vividly clear. Once your astral/spirit animal is at the mirror say the following respectfully :

Oh, great and magnificent spirit, you who have traveled through the wilderness to find me, let us form our bond as was destined to be.

My energy is your energy, my soul is your soul, our heart shall be as one, my will makes it so, so shall it now be.

In dreams I was in the image of you, oh spirit. In dreams I ran through the wilderness in your stead. In dreams we were as one kindred spirit. I felt the astral winds, I heard the cries of my kin in my ears. The whispers of freedom were on my lips. The breath of our kind was in my lungs. This is what was fated to be, my (brother/sister). Guide me now as our bond grows ever stronger. Let us make the pact of kindred souls, binding us as one, meshing into one soul forever.

Look into your astral/spirit's eyes and you will hear it's reply. If it is a warm feeling and kind words - then it is done. If not, then you must perform the ritual over in three days. Three days time in our world is 1 hour in the astral/spirit world. This will be enough time for you to search for another spirit. Keep in mind, some spirits will not wish to merge, this is because they have been wronged by man in their lifetime and hold a resentment - such is the way of some spirits.

When you have connected with your spirit in good tidings, you can view them anytime you wish through a mirror. To do so will strengthen your bond more and more each time. To do this look into the eyes of your reflection (in a mirror, doesn't matter which mirror after the connection) and say:

Guardian Spirit, show yourself so that we may kindle our bond, spirit to spirit, as was meant to be.

You will then see your astral/animal spirit looking back at you. This is a very healthy way to communicate with them as well. Ask them questions, or whatever and they will respond. The feeling of this bond is most incredible and very comforting. You will know each others' thoughts as well as feelings. They are highly intelligent and can give you guidance in everything you wish.

The time will come when the astral/spirit animal will tell you that time has come to merge. When this happens you will perform the next ritual in which you will merge with your astral/spirit animal.

2nd Ritual : Trial of Shadow & Water

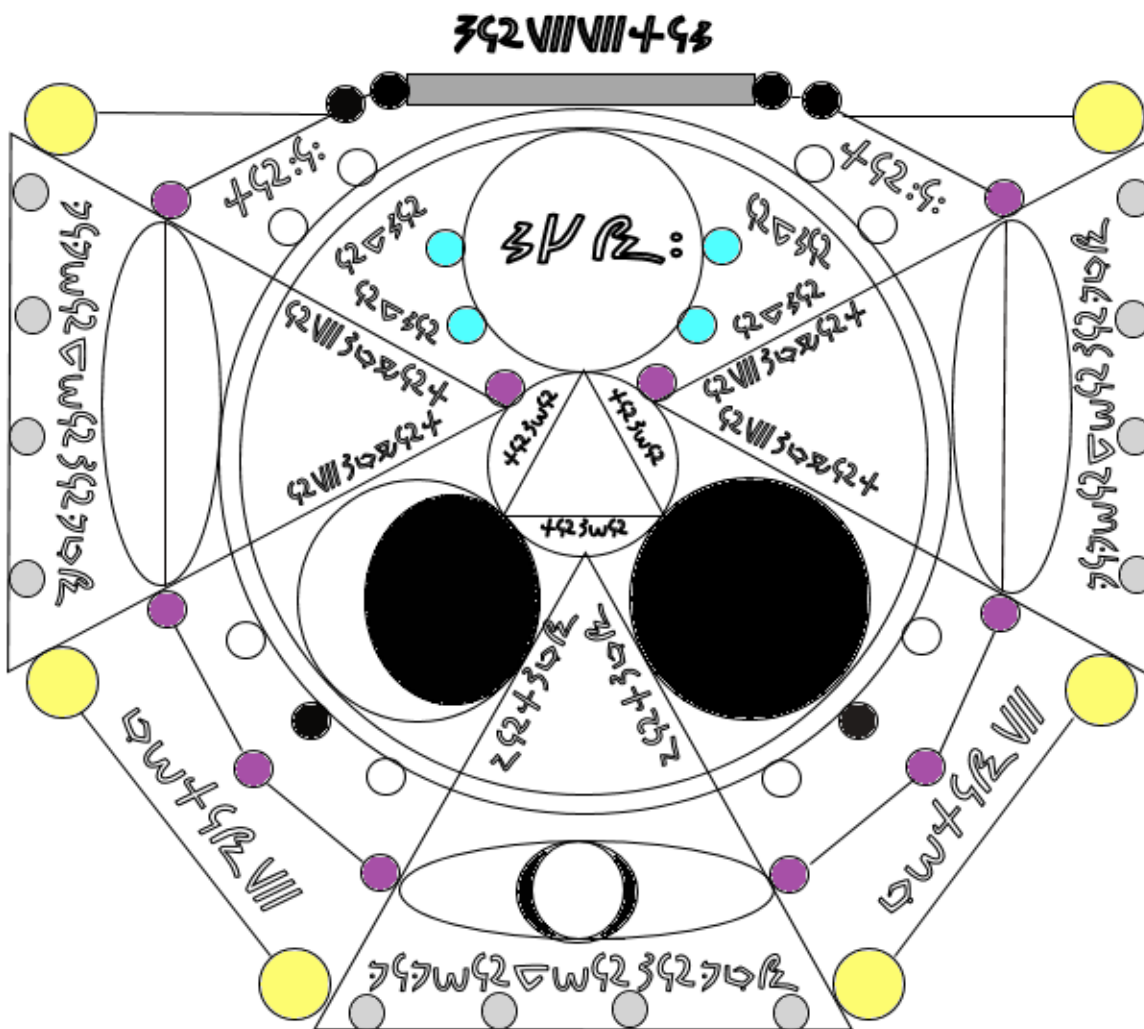

This is the ritual where you merge the astral animal with your own being. This is the next and last step before a fully physical shift. This ritual is very important because not only do you become one with your animal, but you gain a longer life - the energy of your animal will undoubtedly add to your own which is a very generous benefit. This Ritual is to be performed on the second day of the full moon in the hour of Salam (midnight) - no substitutes.

Materials Needed:

- 1 - Large Mirror. (Same one as from the first Ritual).
- 2 - 6 black altar candles (to banish negatives) 3 x 4 inches. Rub Protection Oil from base to wick towards you.
- 3 - 12 silver altar candles (to establish a link with the astral world). 3 x 4 inches standard. Rub Astral Oil from base to wick towards you.
- 4 - 4 zodiac candles with zodiac sign inscribed on them. (represented by light blue on diagram). 3 x 4 standard altar. (official color shall be your zodiac color). Rub appropriate Zodiac Oil from base to wick towards you.
- 5 - 10 purple candles (for connection with astral/spirit animal) (standard altar 3 x 4 inches). Rub Astral Oil from base to wick towards you.
- 6 - 6 Element of Shadow candles (wide altar 4 x 6, yellow). Rub Element of Shadow Oil from base to wick towards you.
- 7 - 8 white altar candles (symbolizes positive energy and change)(standard altar 3 x 4 inches). Rub Spirit Oil from base to wick towards you.
- 8 - 16 cones of Dittany of Crete incense. Place them as follows: One on each side of mirror on the inside, in between the white and black candles. Four in each triangle touching the inner circle's barrier but not inside the inner circle.
- 9 - 16 stone fire censors (for the cones)(anointed with Spirit Oil on each censor base).
- 10 - Sigil of Astral
- 11 - Sigil of Spirit

Begin by drawing the main circle, which will be the diameter of your height. The secondary circles, which represent Luna in her grace, shall be half the diameter of your height and scoped appropriately to represent the phases of the lunar celestial bodies accordingly as pictured above. The inner triangles shall be a measure of your height accordingly on each side. I have color coded the candles this time which will make placement easier.

Place the Astral Sigil on the left side of the inner triangle and the Spiritual Sigil on the right side.

Open your third eye now and focus on your energy pouring from the third eye into the mirror and the two sigils. Concentrate on this feeling and the opening of the third eye - gradually build it to the point of a dull throb, place your palm over your third eye and say: *Coriel Viweh Ameh.*

Light all white candles first and say: *Banish thee negative energy and beings that wish to do me harm. This is no place for you and I shall not permit thee to enter here.*

Light all black candles and say: *It is with protection that this place is cleansed. No harm may come to me or this place that is so sacred. This night shall be blessed and pure. This hour shall begin my rebirth as I welcome my Animal Spirit into my life. We shall be one. My will makes it so, so shall it be. It is now done.*

Light all purple candles and say : *Open the door to the astral world, I summon forth my spirit animal as our connection will light the way. Hear me, brother/sister - I have called upon you to keep your word as we were meant to be. I open my heart to you, let ours beat as one. I open my mind to you, let us think as one. I open my soul to you, let it merge as one.*

Light all silver candles and say : *The connection is most strong - the doors are now laid open. Hear me, brother/sister, I call thee. I guide thee to my sacred place, come and join with me so our bond will forever be complete.*

Light all yellow candles and say : *It is with the astral winds that send me my new life. Make my spirit's journey fast and true so that he/she may find me in this hour of our rebirth. Tonight, we celebrate as one soul.*

Light all cones on the left and say : *Guardian of the West, hear me. You, who grants safe journeys and travel, give aid to my spirit animal so he may find me in the darkness of the wilderness.*

Light all cones on the right and say : *Guardian of the East, hear me. You, who grants protection and wards unseen attacks, protect me and my kindred brother/sister. He/she needs your help to complete our union.*

Light the zodiac candles (depicted as light blue in the diagram) from left to right and say : *Hence, the door opens as we speak (mirror will fog up and you will be able to see your astral/spirit animal.*

Address your animal: *Brother/Sister, I light these candles as a symbol of our union - let it be mind, body, and soul. We shall forever be as one, as was destined to be in this lifetime. With my word, so it is known as blood. I invoke you now, through the door that has been provided, to merge with me as one.*

Standing in the inner triangle of the inner most circle now, look into the mirror. Open yourself, your emotions, your mind, your third eye, and then unleash all the energy you have built up and direct it toward the mirror.

Note: With the aid of the two sigils, the mirror's surface will ripple like water. When this happens, look directly into the eyes of your animal - you will hear the spirit's voice (mentally). You must say at the precise moment it comes to the mirror the following: *I am he/she who has invoked thee, Brother/Sister. Come!*

Your animal will then be able to jump out of the mirror (acting as a portal or gate from the astral/spirit wilderness) and into you.

Congratulations, you have successfully merged with your astral/spirit animal. You might feel very different as the merge completes over the next few days. You might experience sensations and senses that were not there before, do not be alarmed, this is normal during the transfer process.

Note: Now would also be a good time to construct your talisman to prevent sporadic changes on the third day of the full moon in the hour of Yayn on a Sunday. This will ensure that when you call Raphael in his hour he will aid you in the consecration process of your talisman - to have a full effect of the protection and binding (more can be found on this in Chapter 9 of this book.

3rd Ritual : Trial of Fire & Earth

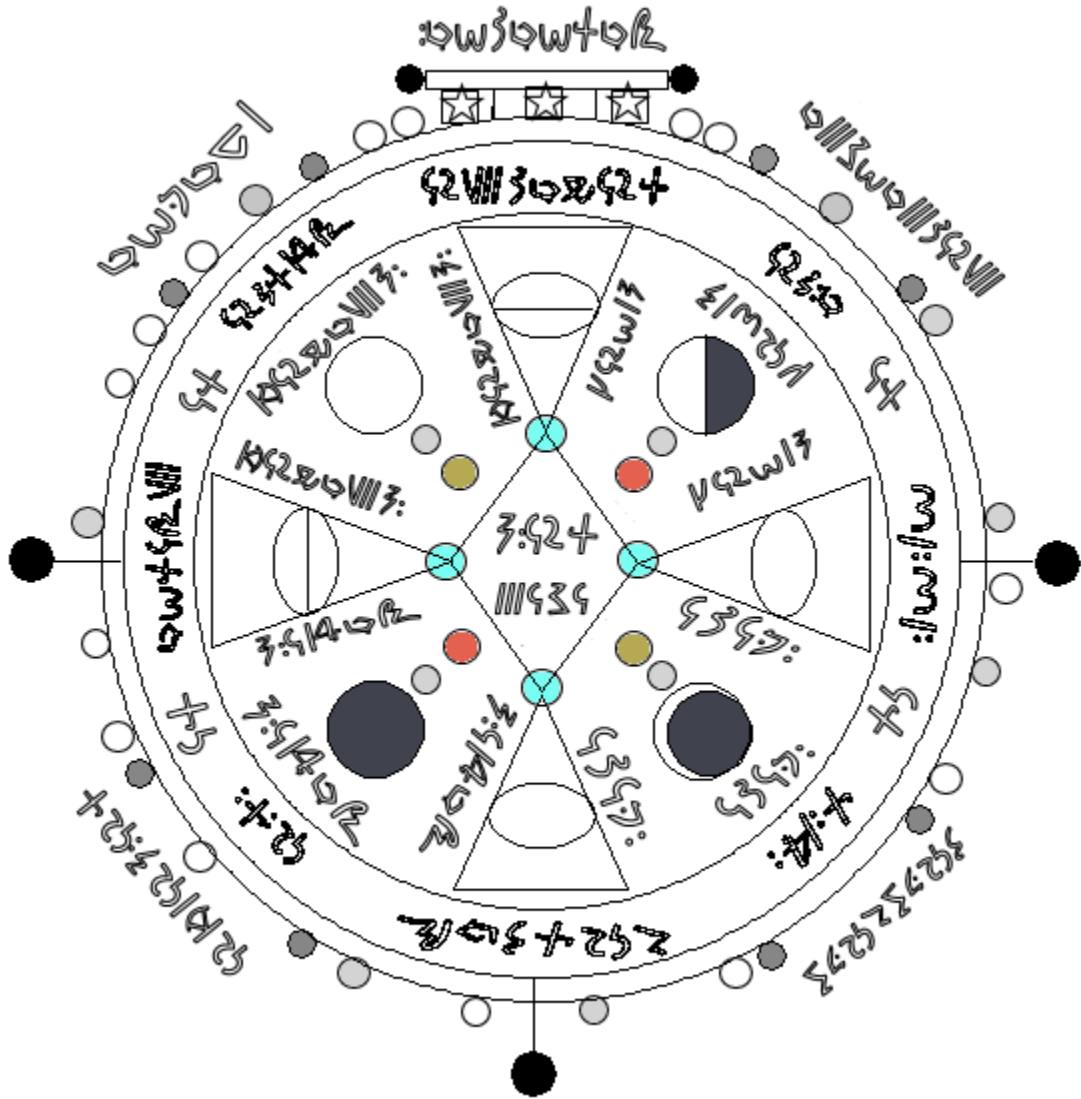

This is the final ritual where you will achieve your first partial transformation. This physical shift can last for a few days or it can last for a few hours. It is highly recommended that you prepare yourself before performing this ritual. I say preparation because, in a way, it can go badly if your spirit animal is not controlled.

It is to be performed on a full moon in its brightest moment. Usually the actual day of the full moon is the brightest moment. It will be done in the hour of Salam. That is ample of enough time to prepare, set up, and perform the said Ritual.

To prepare, you must perform the clearing of the mind meditation until you are positive that the mind does not control your thoughts whenever it wants to. This is a part of the process - there is no explanation for it ... it just happens.

It is very important that you know what your limits are - anger or any other negative emotions can have very bad results - and lead to consequences you might not be able to pay for. Negative emotions can cause sporadic transformations in places you do not want witnesses to view. This impact on society, for the time being, would not be good for our kind.

I would hate to think that you would be chased down and contained in some military facility for the rest of your life - enduring long, hard physically demanding tests as a guinea pig, or worse, being dissected and studied for some bizarre research. Take my word for it when I say that it is not grand nor the attention you want. Think before you act, I always say - this little bit of advice will help you a very long way in life, trust me.

Materials Needed:

1 - Large Mirror (Same mirror as before - This will be your connection to the Dark Matter and will only have to be used this one last time.

2 - 5 shadow (black) altar candles (to banish negatives) 3 x 4 inches. Rub Shadow Oil from wick to base away from you.

3 - 12 silver candles (to establish a link with the Astral world). Standard altar, 3 x 4 inches. Rub Astral Oil from base to wick towards you.

4 - Zodiac candles with your sign inscribed on them. Standard altar, 3 x 4" - they will be placed on each point of the inner diamond on the diagram. Rub the appropriate Zodiac Oil from base to wick towards you.

5 - 8 Spirit candles (dark gray) standard altar, 3 x 4" candle. Rub Spirit Oil from base to wick towards you.

6 - 4 Elemental candles, (2 earth, 2 fire). Fire will be dark red and Earth will be brown. All four will be the standard 3 x 4" altar candle. Rub the appropriate Elemental Oil for each (Fire Oil for Fire, Earth Oil for Earth).

5 - 14 white candles (symbolizes purity & success). Again, rub Protection Oil from base to wick towards you. Each will be standard altar 3 x 4" candles.

6 - 3 cones of Dittany of Crete incense.

7 - 3 stone fire censors (for the cones). Each will be anointed with Success Oil.

8 - Sigil of Astral. Will be placed on the right.

9 - Sigil of Spirit. Will be placed on the left.

10 - Sigil of Physical. Will be placed in front of you.

11 - Sigil of Base. Will be placed behind you.

Begin by drawing out the main circle - start by the inner circle which will be the diameter of your own height - trace around the inner circle twice by 4 inches, creating the appropriate rings as shown above.

You will now make the inner diamond, in which you will stand later in the ritual which is protected by the two holy words that will be written there. Connect the four inner triangles to the diamond as shown above. You will then draw the closed eyes in the triangles which represent the symbol of shadow respectfully, thus leaving the symbols of Spirit open.

You will now draw everything else starting from the north, going clockwise, until you finish with the outer moon symbol.

Go back to the inner circle now, and draw the moon phases starting with the new moon going clockwise until the full moon. Now draw each ankh as depicted in the diagram, starting with the new moon and finishing with the full moon.

Place the mirror as shown above in the diagram. Place all candles and censurs in their designated places as shown in the diagram above.

Light all black candles and each time say: *Merogh*. After all candles are lit, say: *Merog. Ruler of Shadow, you who rests in the Dark Center, grant me your favors in this hour. I ask thee, lend me the Dark Matter I am in need of to achieve my rebirth this night as dictated by Paimon, Amon, Oriens, and Asmodai.*

*Asmodai, guide me and be my strength.
Paimons, guide me and be my insight.
Oriens, guide me and be my voice.
Amon, guide me with your wisdom.
As below, so above -
As was before, so it is again.*

Light all silver candles and each time say: *Sehroh*. After all candles are lit, say: *Sehroh. Ruler of Spirit, you who rests in the Light Center, grant me your favors this night. I am but a child who has stepped into the new existence, no longer am I bound to normal laws, guide me this night with your radiance as I achieve my rebirth.*

*Asmodai, guide me and be my strength.
Paimons, guide me and be my insight.
Oriens, guide me and be my voice.
Amon, guide me with your wisdom.
As above, so below -
As it is again, so it was before.*

Light all zodiac candles from left to right and say:

I am one with Shadow, my essence is one with Merogh. The Ruler of Shadow has granted me my boon. His will is vast and infinite, as is time, as is space, as is his reach. As the Spirit is the Center of Light, so is Shadow the Center of Dark, there must be a balance, there must be a bond, it is so as it has always been.

Light all Spirit Candles and say:

Sehroh, brother of Merogh, I ask thee in this hour, illuminate my path as was meant to be. Asmodai directs me; Paimons directs me; Oriens directs me; Amon directs me; As it has been above, so it has always been below.

Merogh, brother of Sehroh, I ask thee in this hour, illuminate my path as was meant to be. Asmodai directs me; Paimons directs me; Oriens directs me; Amon directs me; As it has been above, so it has always been below.

Open the third eye and begin your breathing - inhale a count of 8, hold 3, exhale a count of 8. You will feel the need to pass out, but do this for a count of how old you are - example, for every two years of your actual age, you must do one count - so if a person was 18 years old, they must count to 9 times.

Light all white candles and say :

*It is with purity of heart that I enter this space -
It is with third eye open that I may see the path intended-
It is with an unmarked soul that I offer my inner self -
It is with my own eyes that I view the truth -
It is with my own mouth that I speak the words intended -
It is with my own heart that I beat my desire in rhythm
with my true intent -
It is with open mind that I accept all consequences for my
actions -*

Asmodai, guide me and be my strength.

Paimons, guide me and be my insight.

Oriens, guide me and be my voice.

Amon, guide me with your wisdom.

As above, so below -

As it is again, so it was before.

Light all cones and say: *The door way between worlds shall open as was intended. Waft the smoke towards the mirror, which will become the doorway. Stand in the center as designated in the diagram above and kneel before the mirror. With your third eye, you will see yourself, your astral/spirit animal, your main morphogenetic Field, and the Morphogenetic Sub-Field.*

You will mentally direct the sub-field above the reflection of your astral/spirit animal in which it's consciousness will attach to it. When this is done say the following:

I, (name), have come before Mistress Saturn, to show that I am aware for the first time in my life. I have become aware of everything that the mysteries have to offer to me. I accept all responsibility for my actions in becoming what fate has led me to. There is nothing in this existence that can shield me from your wrath if I prove to be false.

Face east:

It is with purest intention and belief, that I shall now walk in a valley uncharted by any, only those who have proven their merit dare enter here.

*Asmodai, guide me and be my strength.
Paimons, guide me and be my insight.
Oriens, guide me and be my voice.
Amon, guide me with your wisdom.
As above, so below -
As it is again, so it was before.*

Face West:

It is with humble attitude and positive energy that I accept your grace, Mistress Saturn, for to spite thee will have dire repercussions never witnessed by human eye. Even when I am gone, if I prove to be without merit and let my word slip, I will suffer karmic loss forever and ever. Not only will my astral self dematerialize into the void, but my spiritual self will have no direction and face what is not known, forever and ever.

*Asmodai, guide me and be my strength.
Paimons, guide me and be my insight.
Oriens, guide me and be my voice.
Amon, guide me with your wisdom.
As above, so below -
As it is again, so it was before.*

Face South:

In the eye that sees all, the flame that purges all, the voice that warns all, I am prepared, ready to receive what is fated for me. If I am not of worth, may I be struck down, leaving this mortal coil and descending to the void in which the Ancients live. There I will suffer eternally in the mouth of He who shall remain nameless.

*Asmodai, guide me and be my strength.
Paimons, guide me and be my insight.
Oriens, guide me and be my voice.
Amon, guide me with your wisdom.
As above, so below -
As it is again, so it was before.*

Bow down now before the mirror so that your forehead touches the floor, do not look into the mirror no matter what you hear, feel, or smell. This is a very crucial moment because Mistress Saturn is watching you now through the now open gate (the mirror). If you do look, you are dead. There is no turning back, no hoping, no wishing - just death. You will die and your essence will be cast into the void of the Ancients.

If you do not look and do not die, you will instantly feel the changes at that precise moment. It will feel like liquid fire is all over your body, you will be temporarily blinded, and you will not be able to move. As you are looking at your hands, you will see them change. The Dark Matter is present and will mold to your now intra-body.

Do not worry though, you will not be able to leave the circle at that particular moment, it is a binding circle for your own safety. When you pleaded to Paimon, Oriens, and Asmodai to guide you, this is their way of doing it. That way you don't go around killing everything in sight.

Sad but true, it does takes about a year to fully control what is happening with you from this moment on. When you have the feelings of changing, make sure you create a protective circle so that you will not be able to leave. It is better to have it ready at all times, just in case.

The circle looks like the following:



Remember, keep practicing your meditations. Try focusing on one part of your body, like your arm, and try to change it at will. Really focus on this, and in time you will be able to control your shifts by sheer thought of will.

In the beginning, think of a word that you will remember clearly. This will be your mental key thought - the word you will think of when in animal form to change back. The Dark Matter will do everything it is intended to do, don't worry about where the differential in mass is coming from or going to, that particular step is in the hands of Shadow. You can, however, later down the road, reconstruct yourself to the mass you wish to be - but it takes dedication and patience.

CHAPTER 7



VAMPIER RITUALS

1st Ritual : Summoning Mobloch

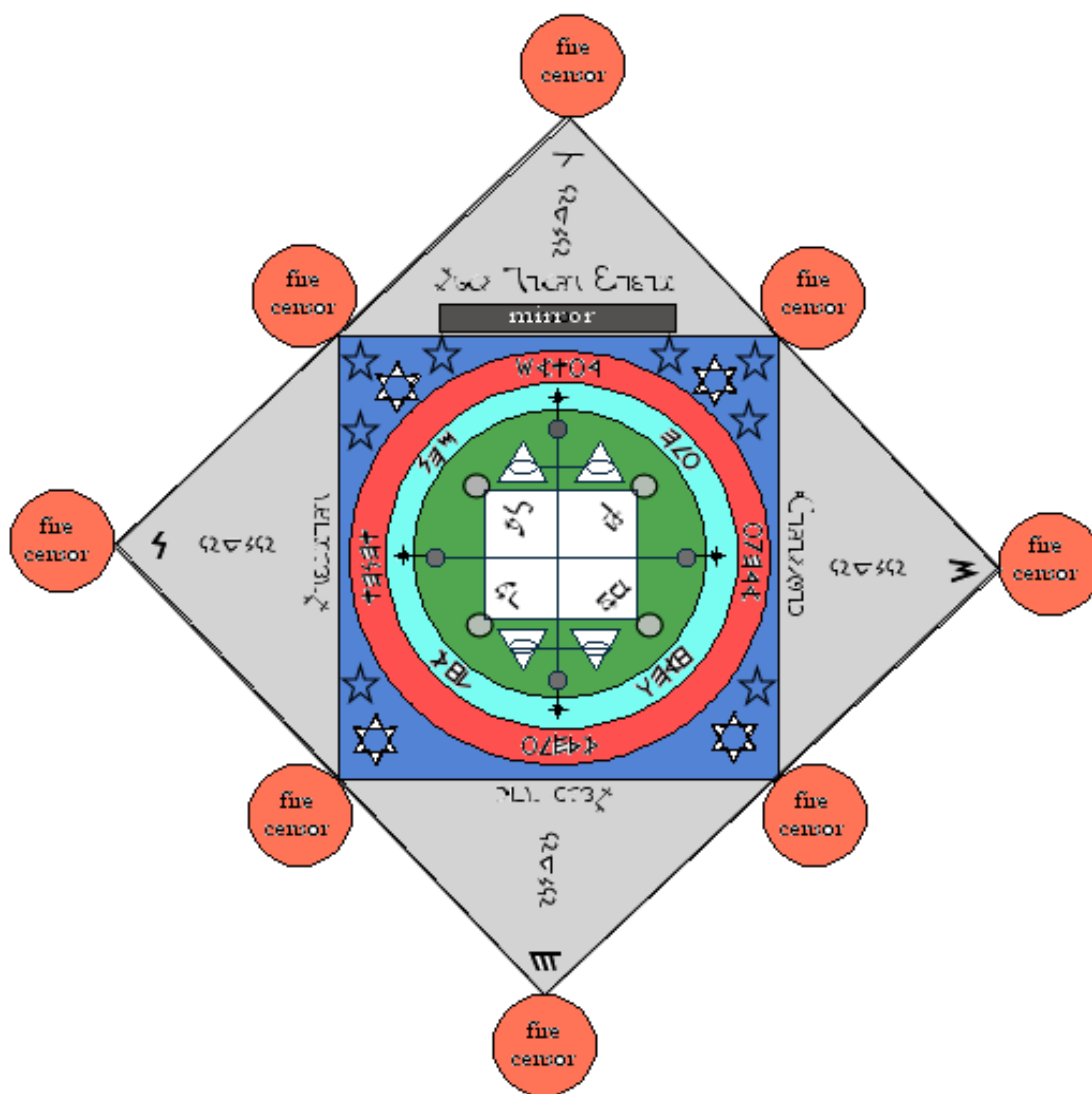

Concerning Vampiers -

Vampiers are the true image of what we call the Vampire. All movie hype and legends of history concerning Vampires originated from the Vampier. There are only a couple hundred left in the world, and it is safe to say that is their own will and volition to remain that way.

Dark Matter plays a role in the genetics of the Vampier - they can change into wolf form, bat form, hybrid form, mist form, and shade form. This is possible because the Dark Matter is strongest with the Vampier - it is literally a being of Shadow.

As long as the entity is merged with the person, no harm can be done to the said person. The said person is not effected by holy ground, religious symbols, or sunlight. The said person does not need blood to survive, but does need energy. To drink blood will give energy, but it is not necessary, the said person can siphon it from the intended victim and achieve the same results. It is possible to change the person back to human if the entity is exorcised, but this book is about how to become one, not to kill one.

The first Vampier ever known in history was an Akkadian King known as Sargon. Believed to be a commoner, Sargon summoned the Demon or Dark Spirit known as Mobloch. Mobloch is an actual demon that resides in Shadow. Of course, his name was erased from all books by the Akkadian Priests for fear of being summoned again. Sargon, once becoming a Vampier, overthrew the Empire in a very short time, setting into motion a law that made every citizen of the empire to worship Mobloch. This was the price stated by Mobloch to Sargon for giving him the power he desired.

Sargon merged with one of the Servitors of Mobloch and became a Child of Shadow - the Vampier. After a while, 20 years to be exact, the Akkadian Priests figured out a way to end the terror of Sargon - they found a way to exorcise the Servitor Entity from Sargon, which would make him human again. Thus the reign of Sargon ended, exorcised by the Priests, mutinied by his own people, and then killed for his Dark corruption.

The rituals -

Summoning the Entity -

This is the ritual to summon the Demon known as Mobloch. To become a Vampier you must make a pact with him first. No blessing, no Vampier.

Materials needed -

1 - a large mirror (like used in the other Rituals, but not the same mirror - it has to be a separate mirror. Anointed with Dark Matter Oil around frame and smeared on mirror.

2 - 16 fire censors with Dittany of Crete cones (mixed with Shadow Oil) and anointed with Dark Matter Oil. All incense is represented by stars for the inner incense and circles with fire censors on the outside incense.

3 - 4 silver candles (one set at each corner of the larger inner square). Rub with Astral Oil from base to wick towards you. Will be standard Altar Candles 3 x 4".

4 - 4 spiritual candles (gray) (placed within the inner circle as in the diagram). Rub Spirit Oil from base to wick towards you. Will be standard Altar Candles 3 x 4".

5 - 1 Athame made of metal with a wooden handle
- inscribed on the wooden handle :

⌘⌘⌘ ⌘⌘⌘⌘⌘

6 - Sigil of Astral

7 - Sigil of Spiritual

8 - Sigil of Physical

Start by drawing the circles (with chalk), which shall be the diameter of your height. The outer rings will be measured 7 inches from each other respectfully.

Draw the inner square of power, followed by the outer square of power. Place the mirror accordingly as depicted in the diagram.

Place the fire censors respectfully as depicted in the diagram. Each censor on the outer edges will have a circle drawn and placed within as shown in the diagram.

Place all writing in this order, starting with the inner circle - North first, East second, West third, South 4th clockwise motion. All writing will be written in the same going outward as depicted in the diagram.

Light the inner censors first and say: *For you, Lord Mobloch. So that our connection is true.*

Light the outer censors and say: *For you, Lord Mobloch. May my path be clear, as is my intent.*

Light the silver candles clockwise and say: *It is in this hour that my desires become clear.*

Light the spiritual candles clockwise and say: *It is in spirit that I call thee to this place. May the door be opened in your presence, Lord Mobloch.*

Place the sigil of astral between the two elemental symbols of spirit.

Place the sigil of spiritual between the two elemental symbols of shadow.

Place the sigil of physical below the sigil of astral.

Take your place in the inner square and kneel before the mirror in the kamai position. Open your third eye now and focus all energy into the mirror. Notice that the other sigils are glowing now. Recite the following:

Lord Mobloch, Keeper of the Unknown Mysteries that lie in the Abyss, you who rule over all dark entities and spirits.

I beseech thee to be favorable to me in calling upon your ineffable presence, in which I offer myself in entirety as your Servitor, bound by my word and merit, to faithfully carry out your word forever.

Asmodai, Prince, I pray thee also, to protect me in my undertaking, for it was your insight that brought me thus far.

Paimon, Great King, be propitious to me and cause that this night I have the strength and will to call the Lord Mobloch to appear to me in good will, without any evil intention, and that He grant me, by all means of the pact which I shall offer to him, so that I may become as was intended for me - to merge with one of his Servitors of Shadow and become a Vampier. This was foreseen and will be as fate declared.

Oh, Lord Mobloch, I beseech thee, leave thy darkness, in whatever part of the Abyss you may be, to come speak with me; if not, I shall thereto compel thee by the power and might names of the High Guardians, in which all Demons give way.

Appear thee instantly as I speak with the power and might names: IXAHAZIEL, MURONEL, NAPILON, OLITAX, ASORNOU, APISAK, ARIEMEM, UTAMOX, TASIPON, RAPHLUZ, ATAZENIEL, EBRERAPH, MARPHESAK, ESSIHANIEL, ABENOMUS, NAHORAROHAEAL, DAPIELEHE, ATATANIEL, SADEHENTIEL, YZAEXN.

After Mobloch appears, make the pact with him. He will give you his word that an Servitor entity will come to you when summoned. Now it is time to go on to the next ritual -

2nd Ritual : Merging w/ Servitor of Mobloch

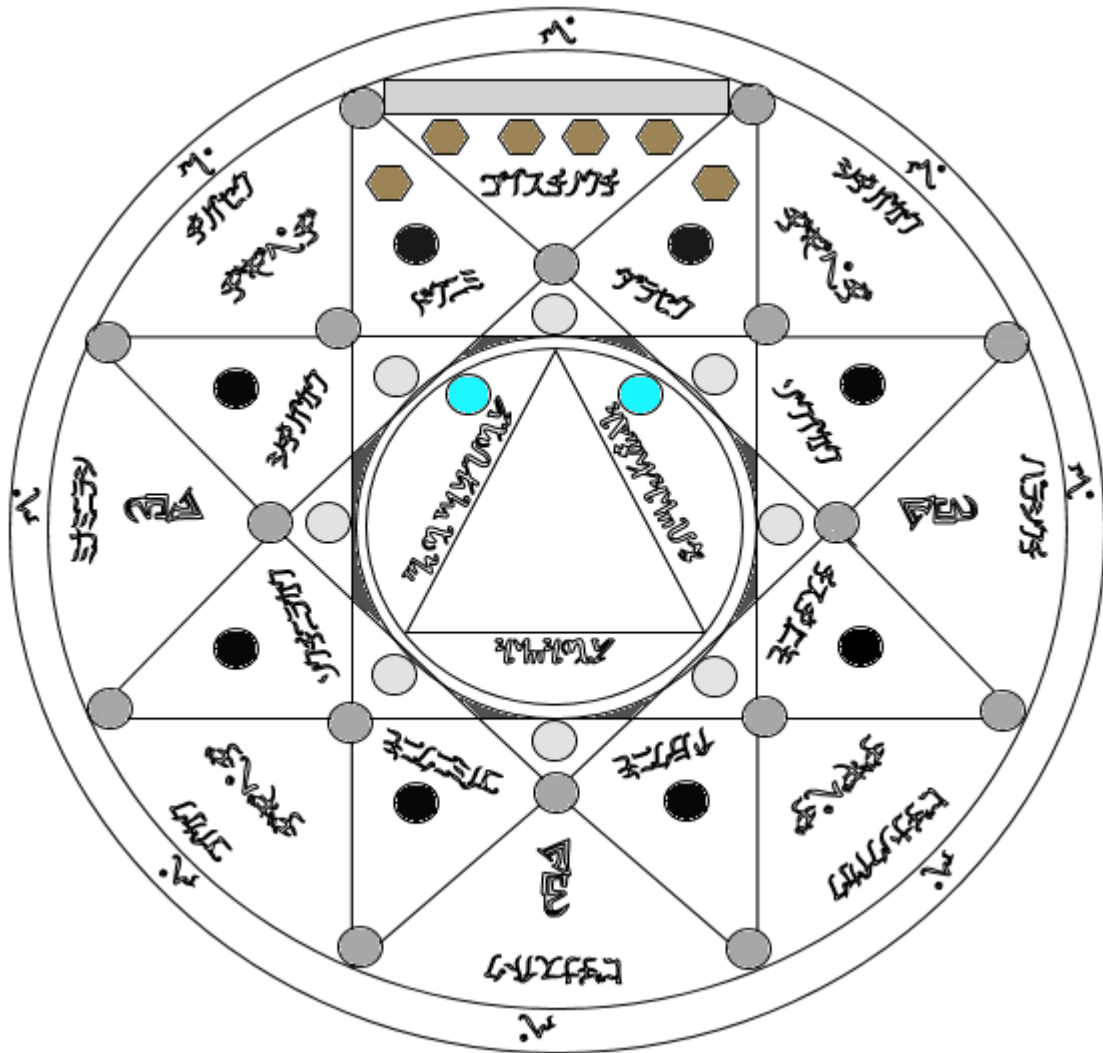

This is the moment you have been waiting for - the merging with the Servitor Entity. You are one step away from becoming a Vampier.

Materials needed -

1 - 15 Spirit candles (placed on every point of each triangle). Dark Gray standard (3 x 4") Altar Candle. Rub each with Spirit Oil and blood from wick to base toward you.

2 - 7 Black Pillar candles (3 x 4"). Rub Dark Matter Oil from base to wick towards you.

3 - 8 Silver Pillar Candles (3 x 4"). Rub Astral Oil with blood from base to wick towards you.

4 - 2 Zodiac Candle w/sign & Elemental Symbol(3 x 4"). Use appropriate color of your Zodiac Sign. Rub appropriate Zodiac oil from base to wick towards you.

5 - 1 Mirror (same mirror used in the Ritual of Summoning Mobloch). Anoint again.

6 - 6 Fire censors. Anoint the four closest ones with Dark Matter Oil and the others with Shadow Oil.

7 - 6 Dittany of Crete incense cones. Two drops of Spirit Oil each on every cone.

8 - 3 Blood Stones. Anoint with one drop Shadow Oil, one drop Dark Matter Oil, and one drop of own blood.

First, draw the main circle, using chalk. It will be exactly 5 ft in diameter as dictated by Mobloch. Then draw all around respectfully by each layer afterwards.

Draw the outer circle, and start writing all incantations (writing) clockwise. Each level will reach around to the next level until you reach the outer circle like a spiral going inward.

Place the mirror on the northern edge of the circle. Make sure that the fire censurs are in front of the mirror so the smoke reaches the mirror.

Place all candles in their appropriate places - double check so there are no mistakes. Everything has to be exactly as dictated in the diagram. There will be no room for error in this last ritual.

Light all black candles and say : *As was before, it is now again. In the honor of my Master, Lord Mobloch, I light the way for my Servitor Entity. Come!*

Light all Spirit candles and say : *As above, so below - this circle is now protected from those who wish to do me harm. Asmodai, Paimon, Oriens, and Amon, guide me and direct me to my rebirth. Come!*

Light all silver candles and say : *I light these candles as a symbol of my awareness. I am ready to accept my pact, it is as it should be. I pledge myself to serve Mobloch for there is no greater honor than to be His Servitor. Come!*

Light the Fire Censurs and say : *Let the gates open. Let the Doors quake and receive me. Come, Shade! Come and accept me as thy host! Come!*

Light the Zodiac Candles and say : *These candles are a representation of myself, my loyalty, my essence, my soul, my heart, my mind, and my body. I have opened the doorway, hear me and obey. Your Lord Mobloch has bid you to come and uphold our pact. Join with me, Entity, Servitor - Merge with me and be reborn into the flesh of the living once more.*

Sit so that you can see your whole body in the mirror, close your eyes and perform the clearing of the mind meditation - inhale for a count of 8, hold 4, exhale for a count of 8. Repeat this until you feel a presence in the room. See the mirror vividly in your mind. Open your third eye now and look into the mirror - pour all of your third eye energy into the mirror, form your hands into a triangle in front of you and say :

*Gateways between Light and Dark, Spirit and Shadow -
Open this night - peel back the layers between mine and
Shadow -*

*Mobloch, guide me and protect me -
Give me the strength and energy I need to complete this
task -*

*It is as it should be, forever and ever -
Let the gate now open -
Let the Servitor appear before me -
Mobloch eiah amiea sammat eiah!*

The gate should open now and the mirror will turn foggy - kind of like when you take a shower and the mirror fogs up. You will now see a Shadow like being looking out - invite him into yourself by saying -

*Servitor, follower of Mobloch, it is by pact that I invoke
you into my being. Merge with me this night in my hour of
need. I hereby open the gate between our worlds, unlocking
that which was locked before. Come forth, Servitor of
Mobloch, merge with me as was meant to be.*

Focus now, all power of your third eye into the mirror - the mirror will ripple and look black - it is then that the Servitor Entity will come forth and join with you.

The Servitor has now merged with your body. It is now that you will feel very drained, but you must close the gateway, cut the power by closing your third eye and performing a banishing and cleansing of the room. This will close the door. Be prepared to sleep a couple of days and also be doubly prepared to feed your Servitor Entity, they require a great deal of energy.

The same method that the shape-changer uses to change forms, the Vampier has the ability built in. Try and focus all of your will by opening your third eye. Invoke what is already yours - Dark Matter - and picture in your head what it is you want to change into - whether it be bat, wolf, shade, mist, or hybrid.

Also, you will eventually develop very strong psychic powers unto your third eye. Stronger than before ... you will have all abilities like the were-creature - strength, speed, etc. The only difference is that a Vampier has the ability to levitate and fly with ease - one of the many benefits from being a Vampier.

It is not known for sure, but if the Servitor Entity remains in the body for a long time it might be able to merge with the essence of the said individual and might transform the said individual using the intra-body created to become something more than expected.

Note: If a very strong binding spell is created to keep the Servitor Entity with the host (usually a symbol burned on the skin), it will be extremely difficult to almost impossible to banish the Servitor from the body. Something to think about if you do not want the Servitor banished from your body.

U CHAPTER 8 P

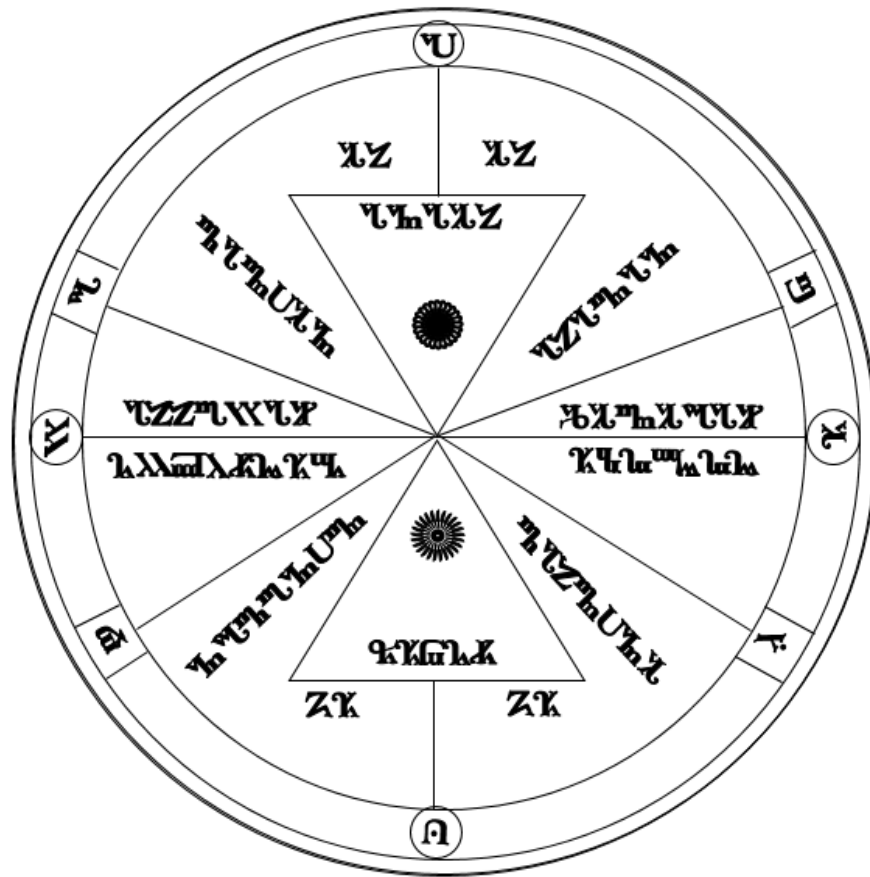

SHAPE CHANGER RITUALS

Concerning Shape-shifters -

The Shape-shifter is a very complex being, even more so than the Were-creature. This is in account because the Shape-shifter has more forms than just one set form. Not only can the Shape-shifter transform into animals, but can change into people as well. This difference is what sets the two beings from each other.

Just like the Were-creature has one sub-field attached to the main field, so does the Shape-changer have multiple fields linked onto the main field. This relationship acts like an astral or spiritual link between them all in the same fashion as that of a necklace. When the individual projects the mental key thoughts he/she can shift through the forms simultaneously as that of flexing a muscle.

It is very laboring, not to mention, mentally, physically, and spiritually exhausting, but it can happen after much practice and developing the skills necessary for this to be achieved.

The steps are as follows for the would-be Shape-changer:

Open the third eye -

Create the Morphogenetic Field and Sub-Fields of the desired forms. It is probably best to only start out with two or three forms in mind - that is a normal and safe number for a beginner..you certainly do not want to overload your mind all at once anyway ... it could lead to insanity and most likely will cause some very bad side effects to boot.

1st **INDOME IADOSMA**
2nd **IAMRA IOLIAL**
3rd **LIEL ILEIEL**

All in all, the only difference between the Were-creature and the Shape-changer, is that the animal forms will not take over your mind. I do not know the extent of why this is, but I did not question POAF. To do so would be an insult unto their intelligence, besides, who am I to question demons - what they say goes.

In the beginning of this book, on the cover, is the Shape-shifter Sigil and there is a second one on the intro page of this chapter as well (the 1st Sigil is more powerful than the second one, but you can use either).

This sigil is only intended for the students who wish to become a Shape-shifter. This sigil represents the necessary power that a student must have to achieve a daily charge. Having the other sigils is beneficial as well, but you can charge the Shape-shifter Sigil with all three forms of energy - Astral, Physical, and Spiritual (added with the Base Sigil will make it twice as powerful).

To do this, you must first prepare a triangle of power. The said triangle will be three feet measured on each side. You will write the following names in Theban for each side - to the East write Furfur, to the West write Asmodai, to the south write Paimon. I have put in a diagram below just in case there is a problem trying to visualize the triangle or if you do not know the Theban language.

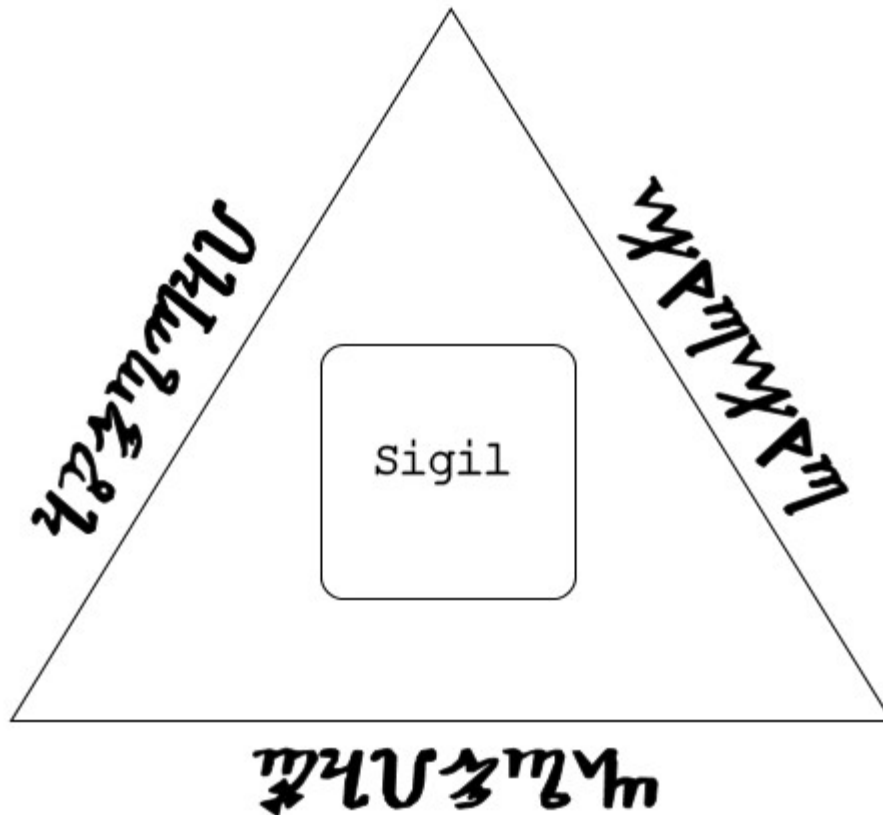

Place the sigil (which is drawn on white parchment with charcoal) inside the triangle. Place the sigil of Astral on the East, the sigil of Physical on the West, and the sigil of Spiritual on the south. When this is done, kneel and open the third eye - focus above the triangle and create your vortex. The vortex is where the Dark Matter can pour through directly into the sigil.

When you focus, see in your mind and in your third eye a portal that goes straight to the source of Shadow - in this portal lies the source, the astral substance that is called Dark Matter. A little hole will open up above the triangle. Three beams of energy will generate from each sigil, hitting the hole, and then directly engulfing the sigil in the triangle. It will be very bright at first, but with the third eye you will see the sigil start to glow.

The sigil is charged now, so you must close the hole. Mentally picture the hole closing and thank Merogh for his blessing.

After this is done, cover the sigils as they once were to use at a later date. As for the Shape-shifters sigil, you must cover it with a gray cloth, on the cloth you must draw an open eye. This will protect the sigil and keep the power within until ready to use. Some forms of Astral and Spiritual entities can drain the power if not protected properly.

1st Ritual: INDOME IADOSMA

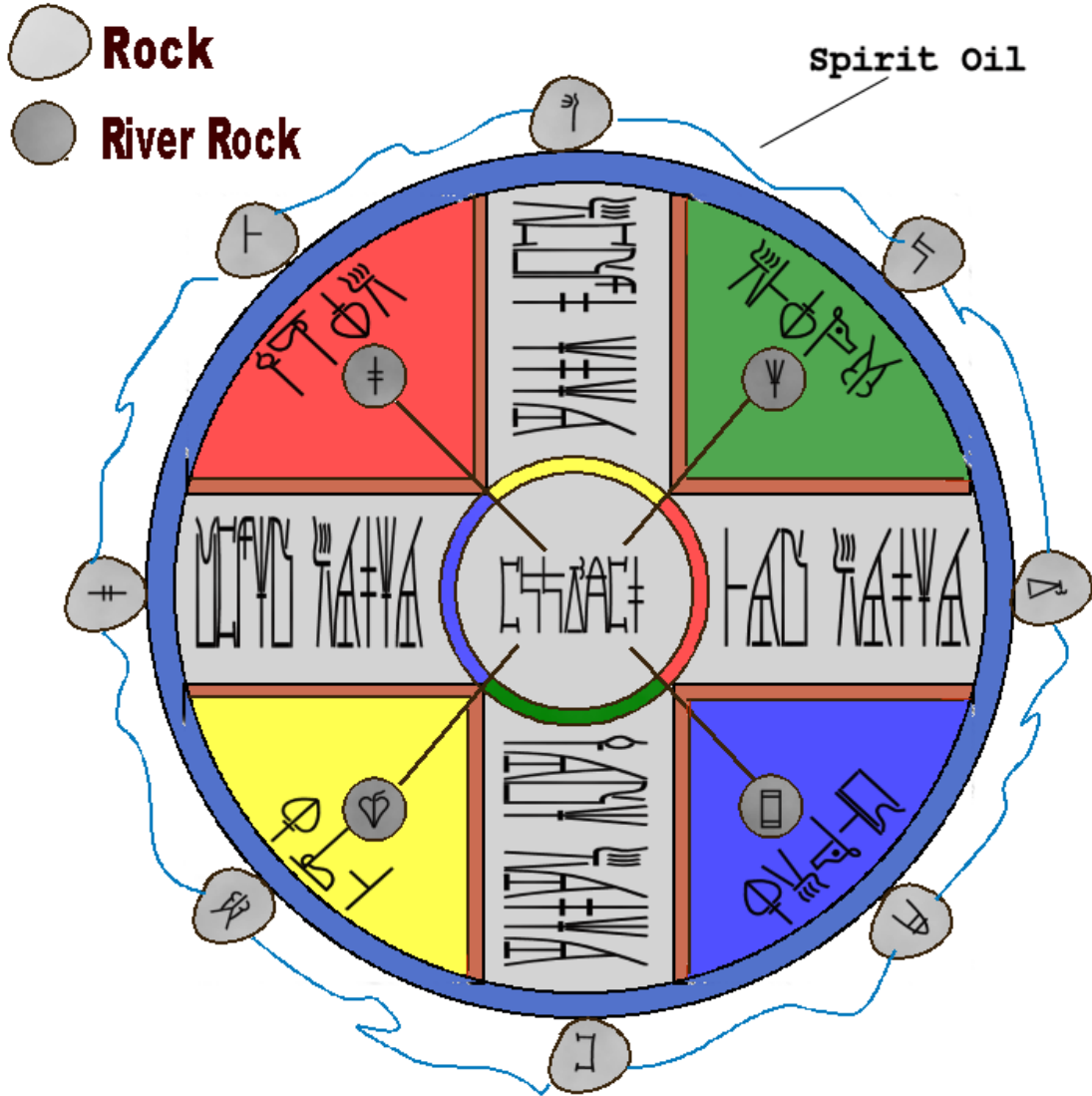

This Ritual is to be performed out on open ground like a hill side or clearing in a forest (as a field within a forest). There is to be no presence of man anywhere near where you are (in visible range). On a Friday night, when the Moon is in the waning stage, in the hour of Caerra (11pm), you will begin to prepare your Ritual Ground. This will include everything that needs to be done so that you can perform what is needed.

Materials needed -

1 - 8 semi-sized Stones that you must find in a slow moving river. They will be 9 - 10 inches in diameter. Must be washed in warm water with salt to cleanse them.

2 - 4 river rocks that you must find in a shallow fast moving river or stream. They will be 5 - 8 inches in diameter. Must be washed in warm water with salt to cleanse them.

3 - Blue powder, Yellow powder, Green powder, Red powder, and brown powder. All powders will have the same properties of that the Native Americans used to paint with. Mostly made of certain plants and roots. All powders can be found in the last chapter of this book.

4 - Spirit Oil will be poured in a direct line around the circle; Shadow Oil will be anointed on the rocks; Dark Matter Oil will be poured around the inner circle; Zodiac Oil (your sign's appropriate oil) will be poured on the prominent lines of the circle; and Astral Oil will be used to anoint the river rocks.

5 - Shape-shifter Sigil 1 or 2 (preferably 1).

This ritual was designed to evoke the Great Spirit who in turn will grant you access to your Spirit Animals for the operation. To get favor from Allowat-Sakima (Great Spirit) is the proper way to receive the necessary help you will need when trying to merge with the Astral Animal Spirits intended.

Allowat-Sakima is also known as Furfur who is listed in the Keys of Solomon (not many people know this). He is one to give the exorcist the ability to change shape and grant the aid of his Animal Spirits in this process.

Begin by creating the inner circle saying these words as you make the circle complete: *Great Spirit, hear me as I complete your wheel. Give me answer to my prayer. These are the colors of your elements, which you have created for us to call you with.*

Create the outer circle and say these words as you are making it: *Allowat-Sakima, I ask for your protection as I create your wheel. As you have done for my fathers and their fathers, so as I ask you do for me. Great Spirit, bring down your mighty shield and protect me from those who wish to harm me. Protect me and grant me your strength to carry out your will and to receive your prayer.*

Place the rocks on the outer circle and each time say: *In turn I seek you, Great Spirit. These are the rocks to complete my belief to you.*

Place the river rocks in the appropriate places saying the following: *Great Spirit, grant me your strength, wisdom and courage.*

Begin to draw out the other lines (not the symbols yet) and say the following: *Here I am creating your shield to protect me, as my father has before and his father before that, back to my father's father and before. I have seen in my visions the past-lives of all. I have seen in my visions what was to be done and to journey here and now to complete my journey. It is here that I make my stand so that I may talk with you, oh Great Spirit. I hear the winds of the trees as they speak in secret. I hear the animals in their many colored coats speak to me of their happiness and care-free lives. I hear the streams and rivers cry to you for their eternal strength. It is here and now I am calling you to me as you have known from the beginning.*

Start to color the insides of the circles now starting with red saying: *Fire is life*. Color brown saying: *Earth is life*. Color water saying: *Water is life*. Color yellow saying: *Air is life*. Stop for a moment when finished and look to the heavens, raising your arms up as if in receiving and say: *The elements I invoke. You, Great Spirit, who have created them for us to use. I invoke the elements into your wheel so that it may be complete. I give thanks to you, Allowat-Sakima, for without your wisdom, without your strength, without your guidance we would all be lost in darkness that the Coyote brings.*

Begin writing the symbols now and take that time to reflect. Do not say any words at this time to show respect and hear what the Great Spirit might have to say to you. Sometimes the wind will kick up or you will notice something else to confirm that Allowat-Sakima is there guiding you.

Sit in the middle circle now and close your eyes. Breathe in through the nose for a count of seven, hold two, and then exhale out through the mouth for a count of seven. Seven is the count for each heartbeat of Mother Earth. As you are falling into a deep trance, open your third eye now and call out to the Great Spirit saying:

Allowat-Sakima, in this wheel of protection I ask you send your Animals to me. Their Spirits will be my strength, as your wisdom will be my own. I ask permission to call the Animals of the Spirit Realm. Answer my call, hear my plea, grant my prayer. As Allowat-Sakima is my voice, come.

It is then they will all come from every corner of the field. They will come and it will seem like they will surround you (which is the case), but do not fear them and do not have any doubts. You will hear very awful noises and see many scary things, but do not move out of the circle. Allowat-Sakima is testing your bravery.

If, by chance, you do run from the protection of the circle, they will give chase and you will die. One fact is that Spiritual Attacks can kill a person - there might be no wounds present on the physical side, but they can do drastic damage to your Spiritual essence. The first ritual is now done and Allowat-Sakima will give you the blessing you seek. Perform a cleansing of the area and a banishing.

Take the rocks that were used in this ritual and bury them apart from each other (not in the same place or area). After each one is buried, thank the Great Spirit for his aid and say a prayer of thanks in your own words.

Spread dirt across the place where the wheel was so that none is visible. Afterwards, a storm will come and wash away the rest. The storm is a sign of purification and of change. This will be your answer from Allowat-Sakima that your call has been heard.

2nd Ritual: IAMRA IOLIAL

This Ritual is to be performed out on open ground like a hill side or clearing in a forest (as a field within a forest). There is to be no presence of man anywhere near where you are (in visible range). Do not pick the same location as the last one - that is not appropriate and the energies from the last Ritual will still be present, so do choose a new location. On a Tuesday night, when the Moon is in the waxing stages, in the hour of Yayn (1am), you will begin to prepare your Ritual Ground. This will include everything that needs to be done so that you can perform what is needed.

Materials needed -

1 - 8 semi-sized Stones that you must find in a fast moving river. They will be 9 - 10 inches in diameter. Must be washed in warm water with salt to cleanse them.

2 - 4 river rocks that you must find in a shallow slow moving river or stream. They will be 5 - 8 inches in diameter. Must be washed in warm water with salt to cleanse them.

3 - Blue powder, Yellow powder, Green powder, Red powder, and brown powder. All powders will have the same properties of that the Native Americans used to paint with. Mostly made of certain plants and roots. All powders can be found in the last chapter of this book.

4 - Spirit Oil will be poured in a direct line around the circle; Shadow Oil will be anointed on the rocks; Dark Matter Oil will be poured around the inner circle; Zodiac Oil (your sign's appropriate oil) will be poured on the prominent lines of the circle; and Astral Oil will be used to anoint the river rocks.

5 - Shape-shifter Sigil 1 or 2 (preferably 1).

6 - A dagger that you must consecrate and purify by your own hands. No outside residues or influences of either energy or otherwise can be present on the dagger. It must be purified and then wrapped in skin (animal hide) for two weeks with no sunlight hitting it (Preferably kept in a dark place like a closet).

The same ritual as the last will ensue only this time you will start with the Earth Direction and follow suit until you fall on fire. This time you will present the Sigil and place it to the left of you and say the following: *As my ancestors have done, so I will complete. Bear witness to my strength for completing the first Ritual, **INDOME IADOSMA**. I have begun my journey as I have promised. Here in your wheel, Great Spirit, I await your judgment. Here I lay my heart and soul for you to see that I am not afraid. Here is my courage for you to see. May your hands now guide me down my path that I must travel alone.*

Afterwards, you will sit cross-legged in the inner wheel and with the dagger, stick it in the ground before you and say the following: *I hear your words, I feel your strength, I am now a part of your wisdom.*

Raise your hands to the heavens and say the following: *By your name, Allowat-Sakima, and your voice - I sit humbly in your wheel. You who created all life, you who showed us your wisdom and guidance. You who created our wills to live, hear me. I call you to come to this place without delay. Protect me from the evil spirits that reside her and send me the Spirits I seek. (call the names of the Animal Spirits you seek - i.e., wolf, bear, raven etc). I call you, (names) - brothers/sisters, do not be afraid. Approach me as your kin. Approach my wheel of the elements and embrace me. Allowat-Sakima, Great Spirit, send all evil spirits away in this hour. Protect me as your child, give to me and bless me with your children so that we may become one.*

Stand now and wait. When you see fog or mist form around the wheel do not be alarmed, this is part of the ritual - they are coming at your request. Speak the following clearly: *In the name of the Great Spirit, Allowat-Sakima, who has given us the foundations of Mother Earth; who has formed the great sky and controls the Spirit World as He sees fit; I ask you to come quickly to my wheel so that I may see you. Come to me from all places, (names of the animal spirit you seek), valleys, mountains, rivers, streams, caverns, grottoes; from every place that you have known in the Spirit World where you rest; by Allowat-Sakima has heard me and I am his voice. Come.*

When they come, stand very still until the ones you seek approach the wheel you are standing in.

You will be able to communicate with them and they with you. Ask their permission to enter your body and merge as one. If you get a positive feeling about this union, ask them to enter the wheel with you and the elements will help you merge. After, take the dagger and cut your arm (preferably not a cut too deep that you bleed to death).

This will show that you are a warrior(ess) and are not afraid. Blood will seal the union. Let one drop hit each element and say the following: *We are now one, brothers/sisters. Allowat-Sakima has blessed us as kin. Our journey is at the beginning as our path is laid out before us now. We are one heart, one body, one mind. As you have added your spirit to me, I have added my own to yours.*

Wipe the blade twice on your pant leg and cover it back up in the cloth. Do as before and perform a banishing of the area and bury the stones once more. Cover the area with dirt and leave the place. Thank Allowat-Sakima for his guidance by leaving dandelions out in a field somewhere, make sure to direct the offering to him. Once more the rain will come and you will have your answer. Also, remember to cleanse the knife when you get home and store it properly as I have instructed before.

3rd Ritual: LIEL ILEIEL

This Ritual is to be performed out on open ground like by a river or stream. There is to be no presence of man anywhere near where you are (in visible range). On a Sunday night, when the Moon is in the waxing stages, in the hour of Nasnia (3am), you will begin to prepare your Ritual Ground. You must perform a banishing ritual of the area first, a cleansing (go into the river or stream and purify yourself), and then make a triple circle with your dagger.

Materials needed -

- 1 - dagger (used in the last ritual (must be purified beforehand)).
- 2 - Sage (to burn as an incense).
- 3 - a fire

Purify yourself by going into the river or stream (best to be naked) and say the following as you are immersing yourself: *Allowat-Sakima, I am of your favor. Purify my body with your essence in this river. Make me whole with your blood. Wash over me strength, courage, and wisdom. You who are the Great Spirit, for ever and ever.*

Walk to the desired spot you have chosen to make your triple protection circle and begin by making a fire. Take the dagger and make the triple protection circle in the ground. The circles have to be at least 4 - 5 ft in diameter for required safety from other spirits who wish to do harm (just in case for safety).

Throw the sage on the fire and step into the circle, once sitting cross-legged raise your arms to the heavens (as if receiving), and say the following: *Allowat-Sakima, in whatever place you may be, send your spirits to me. (names of the animals you wish to evoke). Brothers they are to me on this night. They are a part of me as they were my ancestors - my father, my father's father, and his father before him. Let me continue the line that was laid out before me and will continue after me as you will it.*

Chant the following now in a clear, resonating voice and taking care of the syllables of each word: *Leil Ileil ima chochiel imel nohniel.*

This translates to Ritual of animals, adorn me with your skins. Lay-eel, i (as in sick) - lay-el ee-mah ko-kee-el ee-male no-hen-ee-ail is the proper pronunciation.

Open the third eye now and call out Allowat-Sakima four times. You will see the spirits you have chosen and ask the ma question. The question will be this - Brothers/sisters, has Allowat-Sakima sent you to me as I have desired?

If they reply yes and their auras turn green, they are lying and you shall send them away by saying they are not welcome. This will be done by saying: *Allowat-Sakima sends you away from here with his name and power.* If they say yes and their aura is white then it is the truth and you may leave the circle to embrace them.

The question you ask will always be truth, no spirit evil or good can hide their aura from you since you have the blessing of Allowat-Sakima. Remember that part because it is for your safety. Being possessed by evil animal spirits is not a good thing.

When all is said and done, thank Allowat-Sakima for his blessings and answering your prayer by offering blood (three drops shall suffice and offer some of your energy). In three days time you will start to have vivid dreams of being the animals you have chosen. When this happens, meditate and open your third eye, the vibrations will come quickly (have the sigil out before you) and concentrate on the form you desire. This will trigger the change.

The Dark Matter will add to you. It is best if you do it before a mirror like described in the Were-creature Rituals. Be sure to anoint the frame and the glass with Dark Matter Oil and Spirit Oil.

Chapter 9

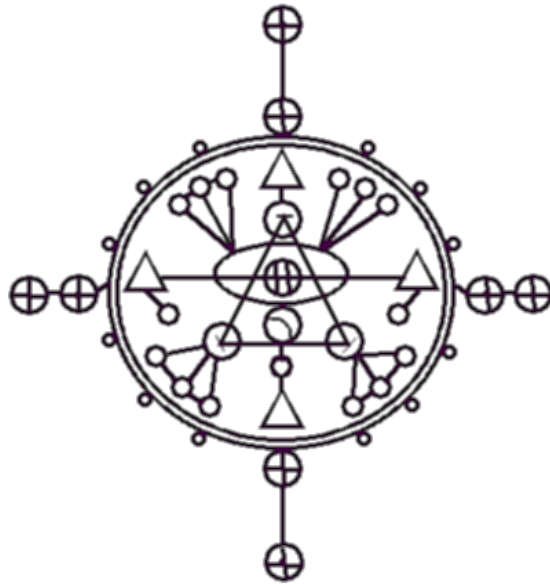

Sigils, Symbols, Oils
&
Incenses Guide

Sigils

This section will deal with information explaining the purpose of and relating to the sigils within this book. This section is my own explanation and they might conflict with other viewpoints and sources.

The proper use of sigils is for creating, causing effects and changes in an individual, their environment, or both, according to the said individual's will. Many approaches to this magickal working can be taken, where experiments and results are either induced, encouraged, or created by a person's belief pertaining to the mechanisms, the directions, or the changes are effective according to the specific need or desire of the person who created them.

Theory of Sigils -

The word **sigil** is derived from the Latin, *signum*, a sign, and is also the root of *sigillum*, a seal. It is part of our common English words *signature*, *sign* and *signal*. It's meaning can be seen in three ways -

- 1 - A thing by which something is made known or represented.
- 2 - Anything visible that indicates the existence of, or approach of something else.
- 3 - Evidence of confirming, authorizing, shutting and securing, and making the creation of Sigils a commonplace process.

In other terms, we use our name as a representation of ourselves to signify who we are. We use our own signature as authorization, it is in fact a visual representation of our being and essence just as a traffic light directs our movement and place in traffic.

A sigil is a visible symbol, representing something else whether it be a goal, desire, or fickle operation to obtain what we seek. In esoteric terms, we have the signs of the Zodiac as representing abstract qualities given to each sign (namely us and how we are in person, spirit, etc). For example, the sign **D** represents qualities of balance, harmony, justice, and so forth.

Magical literature is littered with seals, symbols and sigils used for various purposes (a good example would be The Keys of Solomon or any of the Liber Books). These are often drawn on talismans, daggers, wands, pentacles, or inscribed on robes during ritual.

They can also be drawn on the ground to act as magical circles of protection (as seen prior in this book concerning the Sigils of Astral, Physical, and Spiritual Energies). However, a sigil has a far more specific use to the practical magician, and the intent is to use it as a tool to effect changes in accordance with our own will.

Sigils: A Working Definition -

The esoteric artist, Austin Osman Spare (1888-1956) defined sigils as "the means of guiding and uniting the partially free belief." By saying **partially free belief**, he meant anything desired that was not yet an obsession. This reminds us of Aleister Crowley's injunction to work without lust of result or expected results. That is to say, if the change you require to take place is bigger than you, and you are not in control of it, then you are unlikely to succeed in bringing it about.

Fanatical love or revenge spells rarely work if the person is consumed by the desire. It is far easier to bring change through already available channels in small ways than it is to change the entire universe to suit you the one specific need you are obsessed about. It is easier to work for something with positive intents than negative intents.

For example: if you cast a luck sigil to pay off the bills, start playing games of chance, and then something good happens, it is because it was made out of positive influence rather than selfish gain.

Sigils Working Models -

There are many ways of describing or explaining exactly how a sigil (or any magick for that matter) works. These are fairly irrelevant to the chance of the spell working. You do not have to believe anything to perform the activities of sigil magick. Here are a few of the general beliefs that can be adopted for your own belief if need be:

1- Higher Powers:

When you cast a sigil you are calling upon unseen beings who can interact with the visible universe and bring about the changes you require. These beings have certain characteristics that you must know to work with them.

2 - Magical Influence:

The universe is connected by occult links, which can be mapped by correspondences. Thus, by burning a red candle one can cause anger on the part of another person without there being a visible connecting agent. Blue could be for health or some protection and so on.

Be mindful of associations with everything and what they have a relationship with, this will prove to be very beneficial in the end as you acquire more knowledge and experience down the road.

3 - Unconscious:

Our unconscious mind is tied to the rest of our species by some psychic link or another. By focusing on the desired aim we alert the racial mind to our need and it responds accordingly, usually through the actions of others by ways of hidden influence.

4 - Morphogenetic Field/Sub-Fields:

Also known as a Morphic Field in magick, which is an invisible field generated or forms our species and that of other species. It is also a known magickal link in the various types of energies that surround us and other beings in the universe.

By casting and using a sigil, we link to this invisible field and cause resonant changes in not only our selves, but to other beings, to our own environment and the result leads to changes in all perspectives.

5 - Retro-Temporal Engineering:

Time does not work in a linear fashion as we perceive it. All events have and are happening at the same moment in time. This foundation of thinking is an account of merit and will hold true in most all cases as you will find out later on.

By casting a sigil, we are placing ourselves in the universe where the desired event is taking place, even if this means that events in the apparent past must have happened to make the intended future events transpire. The sigil affects both apparent past and intended future on all levels of awareness (opening the 3rd eye allows it).

Sigils Practice -

The creation of a sigil has two phases - construction and casting. In the first part, the sigil is planned, designed and created as a physical item (although it can be created as a visualized sigil with the same like process). In the second part, it is empowered to make it live, breathe and have its own separate consciousness like a living representative of existence.

Construction Phase -

Begin by stating your aim in one sentence. If it is more complex, simplify it. As in business, if you cannot state what you are aiming for in a single sentence, you are making too much of a hard job of it.

Start the sentence with **My aim is, My desire is,** or **My will is** ... followed by whatever goal you have in mind pertaining to the intention or goal behind the creation of your sigil.

For example, a goal of mine would be as this: My will is to let people know my magick is genuine.

Another useful rule is that "You have to know it when you see it." That is to say, avoid vague statements such as "My will is for my sister to be happier." You must be able to recognize immediately the result which has been aimed for.

In such a case, you might wish to redefine your aim as "My will is to make my sister get the money she needs." This will be far more easier to judge and have direction because now you are stating the aim in the willed desire and thus a goal can be established.

We can construct the sigil from a number of symbolic systems that are out there. In rune-lore, this is known as loading. The basic rule is that all elements of the sigil must be harmonious to both the aim in mind and each other in a simplified manner.

Do not overload your design with the symbols of three hundred traditions or variances that do not coincide in a harmonious manner. This will spell a certain total failure from the get go and should be wary of that. The final result should feel right to you and should have some noticeable energy emanating from it. One way to make sure it rings with a resonance is to close your eyes and hold your palm over it (palm down towards the sigil), you will know if you feel heat, a magnetic pull, or some other sensation regarding a separate intelligence that was created by you.

Some of the basic elements you can create from would be:

- 1 - Art
- 2 - Alphabets
- 3 - Certain specific correspondences
- 4 - Spoken Languages (Mantras) Theban, Enochian, Pictic, Norse Runes, Germanic Symbols, etc.
- 5 - Gestures (Mudras)
- 6 - Numerology Order

For example, you could take the 1st, 15th and 30th letter from the sentence and turn it into a design, like AOX (not pertaining to the actual statement, just figuratively speaking in a manner).

You could further stylize the design, adding other components to it like shapes or other things. You could perhaps paint it on a certain type of wood suited to healing, in a healthy golden color to influence the healing or perhaps blue for insight and dream invocation on a clay tablet to put under your pillow. These are some good examples to start with, but in time you can find your own way.

The next stage is to devise a Mantra to repeat in order to charge the sigil, which will be covered later in this section (this being the usual way, unlike how I describe how to charge sigils in prior sections of my book). This mantra can be derived from your basic sentence, but must not remind you of your aim.

The actual trick is to bypass your conscious mind which can cloud the will by creating imaginary views of success which then limits the nature by which the spell can actually work. Thus, a health sigil could have a mantra created for it like so:

- 1 - Choose relevant key words: heal:permeate:gone.
- 2 - Reversing the words gives us : enogetaemrepleah.
- 3 - Which could be pronounced as a mantra: Hael taema enogra.

Casting Phase -

There are a number of methods by which a sigil - or any other spell form - can be cast. Strangely enough, these boil down to variations of sex, drugs and rock 'n' roll!

The common element to these methods, as with ritual, is a repetitive nature, and the all-consuming manner by which their success takes over the conscious mind. In a sense, they all tend to unity. As we saw in our models of magick, if Unity is the natural state of the universe, methods by which we achieve recognition of that unity are likely to be closer to the mechanics of the universe so that we can cause change to it by our desired effect.

1 - Sex

The use of sex to charge the ritual can be done alone or with partner(s) depending on your resources and preferences. The point of orgasm is often used as the charging moment, but prolonged sexual activity without orgasm can lead to a trance-like state which also can be used.

2 - Drugs

Mind-altering chemicals such as coffee can be used, but as with all techniques mentioned here, seek advice if you use anything whose effects are unknown to you. Drugs like cannabis and hardcore drugs take a different route in which you will only hinder your awareness rather than open it (creating a false sense of being spiritually aware. Drugs like 'X' or weed only falsify awareness and should not be used at all in magickal means in my personal opinion.

3 - Rock n Roll

The use of drums, white noise or repetitive synth-like sounds can lead to the required state in which to cast a sigil easier, but in time you will have to learn how to do this without them to develop your powers.

Clapping also generates a rhythm and there are many tapes and CDs which contain suitable music. Ensure that it is fairly distinct music rather than merely background music.

4- Ritual

The example which follows ensures that the point at which the sigil should be cast is easily recognized, whereas the methods above require some fine tuning. It is better to just create your own experiments and experiences to actually perfect your own methods and preferences regarding each situation. The advantage of ritual is that it formats such methods into easily accessible techniques.

The desired goal is to achieve certain techniques and methods that you can be comfortable with and know will work because you have found them to your liking. Doing these methods will also ensure that the intended state of mind can be reached easily and effortlessly by yourself and with no other aids.

5 -Sigil Ritual Materials

Required: Paper, Marker Pen, one large candle, and one small candle per sigil (basics).

Time Required : 10-15 minutes.

6 - Sigil

Design the sigil on the paper according to the methods described above. Don't be too worried if it doesn't look right - as long as it feels right it will be fine. If you have to redraw it more than three times, abort the ritual and try it again another day when your mind is clear. You can also perform the clearing of the mind technique I explained in the Meditations Chapter of this book to help you focus better.

6 - Mantra

Try to derive a suitable mantra as described above. This should be fairly comfortable to say and have a basic rhythmic pattern. If possible you should try to augment the vowels in the final stage of its creation.

7 - Exchange

If you are working with others, exchange your sigils with each other. This assists the process by which you become disassociated with the aim. If you are doing it for someone else, you have less attachment to the desired result and it is much more effective in nature.

8 - Repetition

Light some candles, if you so wish, and arrange them in a circle around the larger candle (take into consideration the desire and what is associated with that desired goal). If you are working solitary, situate them in the front in consideration of the group.

You must ensure that you can see your sigil and that the mantra has audible functionality. Start to chant out your mantra as clearly and loudly as you can. After a few moments, began to increase the speed of your repetition, breathing faster as you do so. This technique increases the applied energy into the sigil and has a very much greater effect than otherwise.

7 - Clapping/Drumming

As you increase the speed of the chant, begin to clap, slowly at first, then as fast as the chant, and then increase the speed of both until you have an almost continuous nonsensical sound. Drumming is another form of clapping but can produce results closer to the heartbeat of Mother Earth herself.

8 - Release

When you reach the point where you feel as if you cannot speed the chant up, clap loudly once and blow out your candle(s). Visualize the sigil being engulfed by the flame of the candle and vanishing as you extinguish it (if you have the ability to open your third eye you can see the energy for yourself).

9 - Disposal

Dispose of the sigil by burning or simply throw it away, as it is merely a focus and not a consecrated object. That is the normal way of dealing with a sigil based on Enochian and other forms of magick (which is not the case for the sigils I instructed to make earlier in the book because the sigils for the Rituals can be kept and made use of for a very long time).

Make sure to keep a magickal journal so as to have an official written record of each and every ritual. Having a diary of sorts of all your results when they take place will ensure success every time you make a sigil. Review the ritual and the results after every month to make any further observations that were not apparent at the time of the creation. That way you can monitor successes and failures equally.

Symbols

This section we will be dealing with symbols and what they represent as a whole. The most basic kind of symbol that I know of is the circle and can have a variety of uses such as a protection, the outer formation of a sigil, and healing for a few basic methods of description.

Symbols are in fact a secret language we all should recognize, but it is also truth that few are actually fluent in it. The language of symbols is a very wide and vague subject to fully learn and would take a lifetime to get it down pat (opening the 3rd eye is a short cut, so to speak).

Symbols surround us in all types of myriad forms and form the most basic and the most complex parts of our daily lives. Unlike our spoken languages, symbols are presented in all cultures around the world and schooling in Symbolism is left to the individual initiative of pursuit - point taken, either you want to pursue it or you don't. Not everyone has the patience and dedication to seek out the meaning behind symbolism and will not go to lengths to signify the truth behind it all.

Even in religion and religious speaking, symbols are left to the individual initiative. Most religions speak metaphorically and rely on symbols to create a point so that their masses will understand. Of course, the masses do understand, but the religious leaders still take it upon them to treat us like children - like we do not understand big words or something? They continue on and on that symbols are presented as emblems of belonging (which is true), and that mere historical artifacts one wears to identify with one's faith holds ground (in most cases).

I find this to be most truthful except when they judge others for wearing symbols not related to God and other religious excerpts like Jesus, Mary, or angels referred in the Bible. There are no exceptions in my perspective of the situation and all symbols hold religious value. We should never hold any prejudice against other religions even if we do not belong to them. That is just bad form and not being wanting to seek enlightenment as an individual.

Take it from me when I say that you will be better off thinking on your own than being a mindless drone from a group who has no belief but blind faith. Blind faith is a waste of time.

Many of the symbols we take for granted today as static signs (signs that only pertain to one belief like the cross) were created long ago, or representations of the movements of earth and heaven, symbols of the seasons, symbols of the elements (Shadow and Spirit included), and other representations of what we consider to be cosmic and other earthly deities and beings are all included in a very wide range group.

Over time, symbols have acquired many adverse layers of increasingly complex meaning, and this evolution of meaning tells us much about how we developed our ideas about the nature of life and what our universe holds.

Signs and symbols used in modern magick and other Western religious traditions share a most common ancestry that dates back before the creation of any written language. These symbols are very powerful because they are considered what is to be coined as archetypal (ancient). Even the various cultures that do not share a common language share the innate and instinctive comprehension of symbols and what they hold.

In my opinion, I would encourage all would-be seekers of truth and awareness (even illumination) to explore the evolution of symbolism by examining the basic elements that make up the more complex studies and foundations that surround the intricacies of symbolism. Even the symbols of our much loved Western Magick, Astrologies, and Alchemy are based from a common symbolic alphabet. These alphabet composites were created from smaller symbols and through the ages have expanded and grown into everything we know today.

Knowing how to recognize these smaller units, so to speak, will allow a person to decipher many of the larger and more complicated symbols whenever you encounter them (no matter how diverse or vague they might be). It can be a much needed benefit in the future by knowing the secret system behind all the symbols you can encounter. This knowledge will definitely provide an incredible amount of insight into even the most lucrative and shady symbols or signs you will come across. After you learn the basics, the sky and beyond shall be the limit to your studies.

Oils

This section will deal with the oils of the book. There is no lengthy explanation nor any information of historical significance matching the other sections in this chapter - what you see is what you get. All oils that are in this section were given to me as dictated by Paimon, Oriens, Asmodai, Amon, Mobloch and Furfur.

They are in no way subject to change and should remain in their true forms. Any type of tampering with them for Ritual uses other than in this book is highly dangerous and not advised. If you do decide to change them, it is at your own risk and that is all I will say about it.

The Oils themselves are not listed in alphabetical order because it does not matter to have it as such.

Dark Matter Oil

3 dried caterpillars (moth)
1 dram Jojoba Oil
1 pinch Male Fern for Mercury's speed
1 pinch of club moss for the Moon's tears
2 pinches of tobacco for Mars' Blood
3 pinches of Dragon's Blood for potency
3 nights of a new moon (waxing)
1 night of a Blood Moon

All pinches of herbs must be dried and mixed in a mortar and pestle that has been consecrated, purified, and anointed with Saturn Oil. The consecration must take place in the hour of AGLA (10pm) on a Wednesday.

Mash the herbs in a clockwise rotation and then pour in the Jojoba Oil and mix again saying: *the Dark Matter grows, in this oil it will show*. Keep out of sunlight and store properly because the Dark Matter will disperse and the magickal energy will be gone.

The oil must soak in 3 nights of a new moon (in the waxing stage) and 1 night of a blood moon. That is to say, from first hour of darkness (when the sun finally sets) to last hour of darkness (right before the sun rises). The oil will be soaking in the rays of the new moon and blood moon so to speak.

Astral Oil

3 drops crow's blood to bind a gateway between our world and the Astral.

1 dram Jojoba Oil

2 pinches of Bay for protection

1 pinch Chamomile for guidance

1 pinch Sandalwood (red) for strength of spirit

2 pinches of Wood Aloe to bind

3 nights of a full moon in its splendor

1 night of a Storm Moon

All pinches of herbs must be dried and mixed in a mortar and pestle that has been consecrated, purified, and anointed with Mercury Oil. The consecration must take place in the hour of NETOS (7pm) on a Thursday.

Mash the herbs in a clockwise rotation, add in the 3 drops of Crow's blood, and then pour in the Jojoba Oil and mix again saying: *Eye opens, astral winds, wait not, door to spot, bind and grow, this I know.* Keep out of sunlight and store properly because the Astral Energy will disappear.

The oil must be soaked in 3 nights of a full moon and 1 night of a Storm Moon.

Summoning Oil

1 pinch Alfalfa

1 pinch Acacia

1 pinch Alder

1 pinch Birch

2 pinches Balm of Gilead

2 pinches Dittany of Crete

1 dram Jojoba Oil

Protection Oil

1 pinch Dittany of Crete

1 pinch Celery

1 pinch Olive

1 pinch Ginger

1 pinch Carnation

1 pinch Acacia

1 pinch Aloe

1 dram Jojoba Oil

Elemental Oils

My treat to you because all

Fire Oil

1 pinch Ash
1 pinch Basil
1 pinch Curry
2 pinches Dragon's Blood
1 dram Jojoba Oil

Earth Oil

1 pinch Fern
1 pinch Honesty
1 pinch Turnips
2 pinches Sagebrush
1 dram Jojoba Oil

Water Oil

1 pinch Aloe
2 pinches Apple
1 pinch Cherry
1 pinch Eucalyptus
1 dram Jojoba Oil

Air Oil

2 pinches Acacia
1 pinch Broom
1 pinch Lavender
1 dram Jojoba Oil

Shadow Oil

1 pinch primrose
1 pinch palm
1 pinch Ash
1 pinch Dragon's Blood
1 pinch Chamomile
1 pinch Caraway
1 dram Jojoba Oil

Made the same way Dark Matter oil is made. When mixing say the following: Shadows bring, Shadowed things, now Shadow grow in this oil. Keep in a dark place with a clothe that has the Sigil of Shadow on it.

Spirit Oil

2 pinches Dittany of Crete
1 pinch Almond
1 pinch Yew
1 pinch Ars
2 pinches Graveyard Dust
1 Pinch Sandalwood (white)

Moon Oil

1 pinch Balm, Lemon
1 pinch Sage Willow
2 pinches Gourd
2 pinches Grain
1 pinch Grass
1 dram Jojoba Oil

You must soak the finished product in each phase of the new moon beginning with the Waxing version of the New Moon and ending with the New Moon (Waning Version). Do this for three months, especially during the Dyad Moon, Hare Moon and Wolf Moon for better energies.

Success Oil

1 pinch Peony
1 Pinch Clover
2 pinches Frankincense
1 pinch Cinnamon
1 pinch Ash
1 pinch Blackberry
1 dram Jojoba Oil

As mixing clockwise, say the following: make your way, spread your seed, germinate in essence, no resistance I see, success is now bound. My will makes it so, so shall it be. Best to be made on a Tuesday between 9 - 10 pm.

Connection Oil

1 pinch Angelica
1 pinch Carnation
2 pinches Dandelion
1 pinch Acacia
1 pinch Balm of Gilead
2 pinches Dittany of Crete
1 dram Jojoba Oil

Zodiac Oils

Aries Oil

1 pinch Basil
1 pinch Cinnamon
1 pinch Clove
1 dram Jojoba Oil

Taurus Oil

1 pinch Primrose
1 pinch Tulip
1 pinch Sagebrush
1 pinch Fern
1 dram Jojoba Oil

Gemini Oil

1 pinch Almond
1 pinch Clover
1 pinch Sage
1 pinch Lavender
1 dram Jojoba Oil

Libra Oil

1 pinch Hazel
1 pinch Clover
1 pinch Benzoin
1 pinch Parsley
1 dram Jojoba Oil

Cancer Oil

1 pinch Aloe
1 pinch Apple
1 pinch Chamomile
1 dram Jojoba Oil

Leo Oil

1 pinch Cinnamon
1 pinch Angelica
1 pinch Ash
1 dram Jojoba Oil

Virgo Oil

1 pinch Beet
1 pinch Wheat
1 pinch Bistort
1 dram Jojoba Oil

Scorpio Oil

1 pinch Lody's Mantle
2 pinches Dragon's Blood
1 pinch Aloe
1 pinch Blackberry
1 dram Jojoba Oil

Sagittarius Oil

1 pinch Chestnut
2 pinches Basil
2 pinches Alder
1 dram Jojoba Oil

Capricorn Oil

2 pinches Dragon's Blood
1 pinch Amaranth
2 pinches Honeysuckle
1 pinch Horehound
1 dram Jojoba Oil

Aquarius Oil

1 pinch Tamarisk
1 pinch Mistletoe
2 pinches Dandelion
1 dram Jojoba Oil

Pisces Oil

1 pinch Birch
2 pinches Aloe
1 pinch Chestnut
1 pinch Clover
1 dram Clover

Thus concludes our little lesson in making Oils Recipes, hope you enjoyed these never before seen mixtures because no one else has them to date. They are of my own concoction (relating to everything but the Dark Matter Oil and Shadow Oil which was given to me by Asmodai and Amon).

Everything else was by trial and error and it has been a very long time in the making, possibly 8 - 10 years or so now.

Incenses

Well, I was going to say something about incenses in this section but every incense used in this book is pretty simple and can be bought anywhere. I would recommend one of Llewellyn's Online Stores because (so far) they have been the cheapest, and the best quality of product to boot.

Instead this will be a section that allows you to make a talisman to help with the changes when becoming a Were-creature whether it be werewolf, werebear, weretiger, wereraven, werepanther, werelion, werefox (Kitsune), wererhino, were-elephant, or even a weremoose. Pick your flavor as you know you have that special love for a certain animal.

I chose to be a werewolf fifteen years ago and have never looked back ... sometimes I wanted to ... but in the end I am have come to grips.

On to the enchantment of your Talisman -

This ritual is called Conjuration Three - Sorcery Enchantment and is a requirement that I had to pass when I was Part of The Golden Dawn. I give it you now freely so that you may control the physical changes that occur in sporadic moments when you wish they would not. I would recommend wearing the Talisman that you Enchant here and now for the whole duration of the first year after the physical ritual.

In essence, I could get into a lot of trouble for writing this here and now but I deem your safety above everything else no matter what variance the punishment comes in - like anyone could hurt me anyway ... either astral, physical, Spiritual, Psychic, or otherwise (well, unless I let them anyway). Here is what I wrote in my Book of Shadows describing what I did to pass the level and which you can use to Enchant your Talisman as per the Liber KKK. (*my personal way (yet childish action) of saying 'up yours' to the snooty council of the Golden Dawn and to that jerk, Morgan Mogg*).

It is as follows:

- **Conjuration Three - Sorcery Enchantment**

For the work of the third conjuration the magickian may need to prepare or acquire a variety of instruments, but chief among these should be a single special tool or weapon (magickal) for enchantment. A small pointed wand or knife (dagger) are especially convenient.

This special instrument or weapon can also be usefully employed to trace the pentagrams in the Gnostic Banishing Ritual previously mentioned. A fist sized piece of modeling clay or other plastic material may be the only other instrument required. To perform Sorcery Enchantment magickian makes physical representations of his/her will and desire.

Where possible, the magickal weapon should be used to help make or manipulate these representations. The magickian should perform one or several conjurations of this type per week for a duration of 6 months or until known accordingly that the magickian's will and desire can be met through the process of Sorcery Enchantment each time performed.

As always, he/she should aim to influence events before nature has made up her mind, and the magickian should not put too great a strain on nature by conjuring for highly improbable events.

You must know that this was the most of trials I have ever performed in my opinion and the easiest I have ever done. The only single most easiest events compared to the trials I have performed are protections, banishments, healing, and predictions (both from a distance and in person). Anyway, here is what I did to enchant an item which I am giving to you in accordance of my own free will as to uphold my word that your safety is most important to me:

As Drawn in my Book of Shadows:

- 1 - take the weapon and create a magickal circle starting with Earth & Fire mixture.
- 2 - charge the weapon with energy
- 3 - use the weapon and instill thy will and desire.
- 4 - chant what needs to be

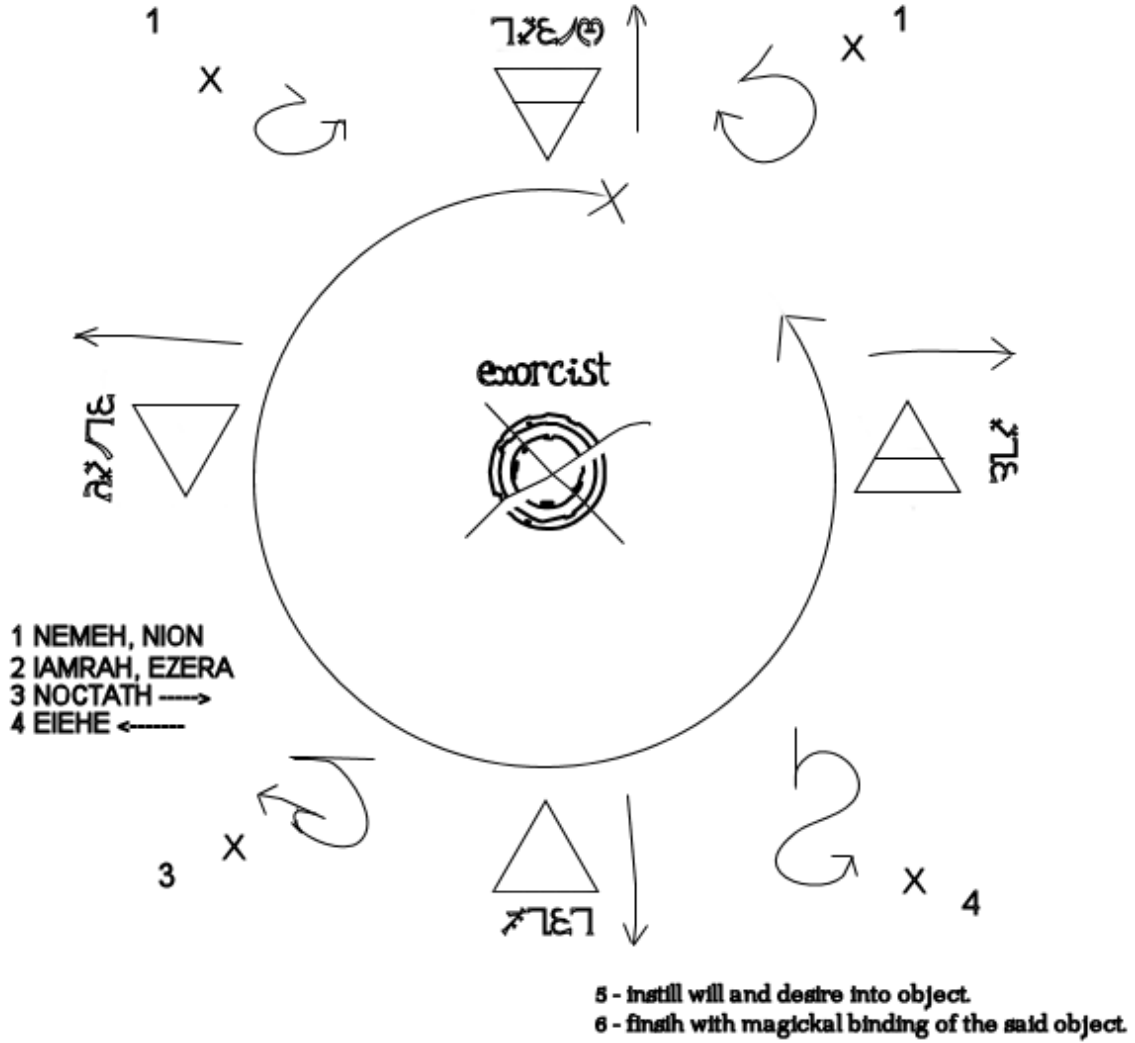

This will in fact enchant the talisman you have in your possession to be effective enough to bind you for a time (being that you will charge it each full moon every month for the first year). Simple as that and it only takes once a month to charge. The object has to be a necklace of some kind so as to be worn around the neck to make sure that it is on your body at all times.

In the event that you have the necklace off, it is desired that you have the binding circle at ready and in close proximity at all times. This will effect your social life unless you have a very strong will to control the urges of sporadic changes that will eventually occur. Keep in check all negative emotions like anger or the desire to do harm. These emotions will trigger a sporadic physical change on your being wherever you may be - I highly recommend you perform the Sorcery Enchantment of the Talisman in any case.

Books I recommend for further study:

Cunningham's Encyclopedia Of Magickal Herbs (Expanded & Revised Edition by Scott Cunnigham).

The Keys of Solomon the King (Lesser and Greater) translated by S. Liddell Macgregor Mathers.

All Liber Books

Sacred Magick of Abremelin the Mage

The Golden Dawn

The Enochian Keys

The Witches' Almanac

A Little Book of Candle Magic by D.J. Conway

The Sacred Path Workbook

Il Libro Della Magia by William R. Wraith

Pro Novus Coepti by William R. Wraith

[My email is william_wraith@yahoo.com](mailto:william_wraith@yahoo.com) for any questions you may have regarding this book.

To End

William B. Waitke